

# ETSI ES 201 962 V1.1.1 (2001-09)

---

*ETSI Standard*

## **Terrestrial Trunked Radio (TETRA); TETRA Advanced Packet Service (TAPS)**

---

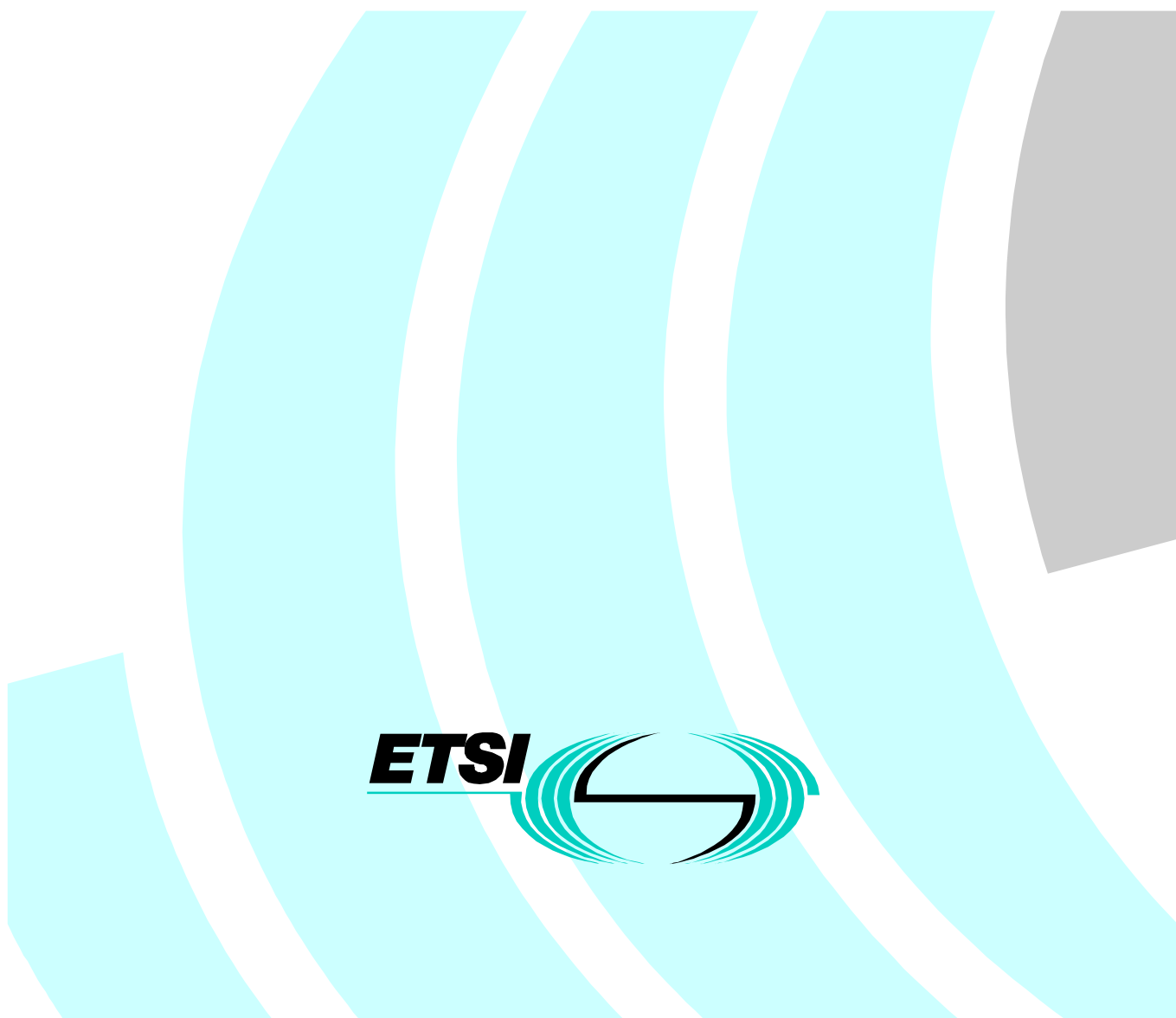

---

**Reference**

DES/TETRA-04058

---

**Keywords**

data, radio, TETRA

**ETSI**

---

650 Route des Lucioles  
F-06921 Sophia Antipolis Cedex - FRANCE

Tel.: +33 4 92 94 42 00 Fax: +33 4 93 65 47 16

Siret N° 348 623 562 00017 - NAF 742 C  
Association à but non lucratif enregistrée à la  
Sous-Préfecture de Grasse (06) N° 7803/88

---

**Important notice**

Individual copies of the present document can be downloaded from:

<http://www.etsi.org>

The present document may be made available in more than one electronic version or in print. In any case of existing or perceived difference in contents between such versions, the reference version is the Portable Document Format (PDF). In case of dispute, the reference shall be the printing on ETSI printers of the PDF version kept on a specific network drive within ETSI Secretariat.

Users of the present document should be aware that the document may be subject to revision or change of status. Information on the current status of this and other ETSI documents is available at

<http://portal.etsi.org/tb/status/status.asp>

If you find errors in the present document, send your comment to:

[editor@etsi.fr](mailto:editor@etsi.fr)

---

**Copyright Notification**

No part may be reproduced except as authorized by written permission.  
The copyright and the foregoing restriction extend to reproduction in all media.

© European Telecommunications Standards Institute 2001.  
All rights reserved.

# Contents

Intellectual Property Rights .....	10
Foreword.....	10
1 Scope .....	11
2 References .....	11
3 Definitions and abbreviations.....	18
3.1 Definitions .....	18
3.2 Abbreviations .....	18
4 TAPS requirements .....	18
4.1 Applicable 3GPP specifications .....	19
4.2 Applicability of GSM 03.22 .....	23
4.3 Applicability of GSM 03.33 .....	24
4.4 Applicability of GSM 04.13 .....	25
4.5 Applicability of GSM 04.14 .....	25
4.6 Applicability of GSM 04.18 .....	26
4.7 Applicability of GSM 04.60 .....	30
4.8 Applicability of GSM 05.01 .....	31
4.9 Applicability of GSM 05.02 .....	32
4.10 Applicability of GSM 05.03 .....	33
4.11 Applicability of GSM 05.05 .....	36
4.12 Applicability of GSM 05.08 .....	37
4.13 Applicability of GSM 05.10 .....	38
4.14 Applicability of GSM 08.02 .....	39
4.15 Applicability of GSM 08.08 .....	39
4.16 Applicability of GSM 08.52 .....	40
4.17 Applicability of GSM 08.58 .....	40
4.18 Applicability of GSM 11.11 .....	40
4.19 Applicability of GSM 11.14 .....	41
4.20 Applicability of TS 22.030 .....	42
4.21 Applicability of TS 22.038 .....	42
4.22 Applicability of TS 23.002 .....	43
4.23 Applicability of TS 23.016 .....	44
4.24 Applicability of TS 24.007 .....	44
4.25 Applicability of TS 24.008 .....	45
4.26 Applicability of TS 24.011 .....	56
4.27 Applicability of TS 27.007 .....	57
4.28 Applicability of TS 29.002 .....	58
4.29 Applicability of TS 29.010 .....	62
4.30 Applicability of TS 29.078 .....	62
<b>Annex A (normative): Modification to GSM 04.18.....</b>	<b>63</b>
1.5 Use of logical channels.....	63
1.6.1 List of procedures .....	63
1.7.2 General Packet Radio Service (GPRS) .....	64
2.1.2 Vocabulary.....	64
3.1 Overview/General .....	65
3.1.1 General.....	65
3.1.2.1 Idle mode .....	65
3.1.2.2 Dedicated mode.....	66
3.1.2.6 Packet transfer mode .....	66
3.1.4.3 Sequenced message transfer operation.....	66
3.1.6 Pre-emption.....	67
3.2.1 Mobile Station side .....	67
3.2.2.1 System information broadcasting .....	68
3.3.1.1.1 Permission to access the network .....	69

3.3.2.1	Paging initiation by the network .....	70
3.3.2.1.1	Paging initiation using paging subchannel on CCCH.....	71
3.4	Procedures in dedicated mode .....	72
3.4.1.1	General .....	72
3.4.1.2	Measurement report and Enhanced Measurement Report.....	73
3.4.1.2.1	Parameters for Measurements and Reporting .....	73
3.4.1.3	Extended measurement report \$(MAFA)\$.....	74
3.4.2	Transfer of messages and link layer service provision .....	74
3.4.3	Channel assignment procedure .....	75
3.4.3.1	Channel assignment initiation .....	75
3.4.3.3	Abnormal cases .....	76
3.4.4	Handover procedure.....	77
3.4.4.1	Handover initiation.....	77
3.4.4.3	Handover completion .....	78
3.4.4.4	Abnormal cases .....	78
3.4.5	Frequency redefinition procedure .....	79
3.4.7	Cipherring mode setting procedure .....	79
3.4.10	Classmark change procedure .....	80
3.4.11	Classmark interrogation procedure .....	80
3.4.11.2	Classmark interrogation completion .....	80
3.4.13.1	Normal release procedure .....	80
3.4.13.1.1	Channel release procedure initiation in dedicated mode .....	80
3.4.13.2	Radio link failure in dedicated mode .....	81
3.4.13.2.1	Mobile side .....	82
3.4.13.2.2	Network side.....	82
3.4.13.3	RR connection abortion in dedicated mode .....	82
3.4.19	Assignment to a Packet Data channel .....	82
3.4.19.3	Abnormal cases .....	83
3.4.20	RR-Network Commanded Cell Change Order .....	83
3.4.20.1	RR-network commanded cell change order initiation .....	84
3.4.20.3	Abnormal cases .....	84
8.5.1	Radio resource management .....	85
9	Message functional definitions and contents.....	85
9.1	Messages for Radio Resources management.....	86
9.1.7	Channel release .....	87
9.1.8	Channel request .....	87
9.1.11.2	Mobile Station Classmark .....	89
9.1.15	Handover command.....	89
9.1.21e	RR-Cell Change Order.....	90
10.1	Overview .....	91
10.4	Message Type.....	92
10.5	Other information elements .....	93
10.5.2.6	Channel Mode .....	94
10.5.2.7	Channel Mode 2 .....	95
10.5.2.40	Timing Advance.....	95
10.5.2.47	Suspension Cause.....	96
11.1.1	Timers on the mobile station side .....	96
11.1.2	Timers on the network side.....	98
11.1.3	Other parameters.....	99

**Annex F to GSM 04.18 (informative): GSM specific cause values for radio resource management ....100**

<b>Annex B (normative):</b>	<b>Modification to GSM 04.60 .....</b>	<b>102</b>
3.1	Vocabulary .....	102
5.2.4	Medium Access modes .....	103
5.5	General procedures in packet idle and packet transfer modes .....	103
5.5.1.1b.1	General .....	104
5.5.1.5	Discontinuous reception (DRX).....	104
5.5.1.6	Page mode procedures on PCCCH.....	105
5.5.1.7	Frequency Parameters .....	105
5.5.2.1.3	System information on PACCH (and other logical channels) .....	106

5.6.1	Network Control (NC) measurement reporting .....	107
5.6.3.3	Deriving the Neighbour Cell list from the GSM Neighbour Cell list.....	108
5.6.3.5	GPRS Report Priority Descriptions.....	108
5.6.3.6	GPRS Measurement Parameters and GPRS 3G Measurement Parameters.....	108
6.1	Paging procedure for RR connection establishment.....	108
6.1.3	Paging initiation using PACCH.....	108
6.1.4	Paging response .....	109
6.2	Paging procedure for downlink packet transfer.....	109
7.1	TBF establishment initiated by the mobile station on PCCCH .....	109
7.1.2.1	Initiation of the packet access procedure .....	109
7.1.2.2.4	Packet access reject procedure .....	110
7.2	TBF establishment initiated by the network on PCCCH.....	111
7.4.1	Cell Change Order procedure initiated on PCCCH .....	111
7.4.2	Cell Change Order procedure initiated on CCCH.....	112
8.0	General .....	112
8.1.0	Medium access mode.....	112
8.1.1.1	Dynamic allocation uplink RLC data block transfer.....	113
8.1.1.1.2	Resource Reallocation for Uplink .....	113
8.1.1.3.2	Reallocation for open-ended TBF .....	116
8.1.1.5	Abnormal cases .....	118
8.1.2.1	Downlink RLC data block transfer .....	119
8.1.2.1.1	Abnormal cases .....	119
8.1.2.4.1	Abnormal cases .....	120
8.1.2.5.1	Abnormal cases .....	120
8.1.2.8	Network initiated abnormal release of downlink TBF .....	121
8.4	Network controlled cell reselection procedure.....	121
8.4.2	Abnormal cases.....	121
8.7.1	Abnormal release without retry .....	122
8.7.2	Abnormal release with access retry .....	122
9.3.2.4	Release of uplink Temporary Block Flow .....	122
9.3.2.6	Release of downlink Temporary Block Flow.....	124
9.3.3.3	Release of uplink Temporary Block Flow .....	124
9.3.3.5	Release of downlink Temporary Block Flow.....	126
9.4.2	Abnormal release with cell reselection .....	126
10.4.10a	Power Reduction (PR) field.....	126
11.2	RLC/MAC control messages.....	127
12.1	Overview .....	128
<b>Annex C (normative): Modification to GSM 05.01 .....</b>		<b>129</b>
2	Set of channels .....	129
3	Reference configuration .....	131
4	The block structures .....	131
5.1	Hyperframes, superframes and multiframe.....	133
5.2	Time slots and bursts .....	133
5.3	Channel organization.....	135
6	Frequency hopping capability .....	136
7.1	General .....	138
9	Transmission and reception.....	138
10	Other layer 1 functions.....	141
11	Performance .....	141
<b>Annex D (normative): Modifications to GSM 05.02 .....</b>		<b>142</b>
3.2.1	General.....	142
3.3.1	General.....	143
3.3.2.4.1	Packet Broadcast Control Channel (PBCCH) .....	143
3.3.3.1	Common control type channels, known when combined as a common control channel (CCCH).....	143
3.3.3.2.1	Packet Common Control Channels (PCCCH).....	143
3.3.4.1	Circuit switched dedicated control channels .....	143

5.2.3	Normal burst (NB).....	144
5.2.5	Synchronization Burst (SB).....	145
6.2.1	General.....	146
6.2.2	Parameters.....	146
6.2.3	Hopping sequence generation.....	146
6.3.1.2	Key to the mapping table of clause 7.....	147
6.3.1.3	Mapping of BCCH data.....	148
6.3.2.2.1	Mapping of uplink packet traffic channel (PDTCH/U) and PACCH/U.....	149
6.3.2.2.2	Mapping of the Packet Timing Advance Control Channel (PTCCH/U).....	149
6.4.1	Permitted channel combinations onto a basic physical channel.....	149
6.4.2	Multislot configurations.....	150
6.5.1	General.....	150
B.1	MS classes for multislot capability.....	168
B.2	Constraints imposed by the service selected.....	170
B.3	Network requirements for supporting MS multislot classes.....	170
<b>Annex E (normative): Modifications to GSM 05.03 .....</b>		<b>172</b>
2.1	General organization.....	172
2.2	Naming Convention.....	176
4.1.3	Convolutional encoder.....	177
4.1.4	Interleaving.....	177
4.2.4	Interleaving.....	177
4.2.5	Mapping on a Burst.....	178
4.3.4	Interleaving.....	178
4.3.5	Mapping on a Burst.....	178
4.4	Broadcast control, Paging, Access grant, Notification and Cell broadcast channels (BCCH, PCH, AGCH, CBCH),.....	179
4.6	Random access channel (RACH).....	179
4.7	Synchronization channel (SCH), Compact synchronization channel (CSCH),.....	179
5.1.2.3	Convolutional encoder.....	180
5.1.3.3	Convolutional encoder.....	180
5.3.2	Extended Packet Access Burst.....	181
5.4	Access Burst on packet switched channels other than PRACH and CPRACH.....	181
<b>Annex A to GSM 05.03 (informative): Summary of Channel Types .....</b>		<b>184</b>
<b>Annex B to GSM 05.03 (informative): Summary of Polynomials Used for Convolutional Codes .....</b>		<b>185</b>
<b>Annex F (normative): Modification to GSM 05.05 .....</b>		<b>186</b>
2	Frequency bands and channel arrangement.....	186
4.1.1	Mobile Station.....	189
4.3.2.1	General requirements.....	191
4.3.3.1	Mobile Station GSM 400, GSM 900 and DCS 1800.....	192
4.5.1	Base Transceiver Station.....	193
5	Receiver characteristics.....	194
5.1	Blocking characteristics.....	194
6.1.1	GMSK modulation.....	198
6.2	Reference sensitivity level.....	198
6.3	Reference interference level.....	201
6.4	Erroneous frame indication performance.....	202
6.7	Incremental Redundancy Performance for EGPRS MS.....	202
<b>Annex G (normative): Modification to GSM 05.08 .....</b>		<b>205</b>
2	General.....	205
3.3	BSS measurement procedure.....	206
3.4	Strategy.....	206
4.2	MS implementation.....	207
4.3	MS power control range.....	207

4.4	BSS implementation.....	208
4.7	Timing .....	208
5.1	Criterion .....	208
5.2	MS procedure .....	209
5.3	BSS procedure.....	209
6.6.1	Monitoring of received signal level and BCCH data.....	209
6.7.2	Call re-establishment .....	210
8.2.3	Statistical parameters .....	211
8.2.4	Range of parameter RXQUAL .....	211
8.4.1	Measurement reporting for the MS on a TCH.....	212
8.4.2	Measurement reporting for the MS on a SDCCH.....	213
8.4.4	Common aspects for the MS on a TCH or a SDCCH.....	214
8.4.6	Extended measurement reporting .....	214
8.4.8.2	Measurement Reporting .....	215
9	Control parameters .....	215
10.1	Cell Re-selection .....	219
10.1.4.3	Exceptional cases .....	219
10.2.3.2.1	Packet transfer mode .....	219
A.2	Functional requirement.....	222
<b>Annex H (normative): Modification to GSM 05.10 .....</b>		<b>223</b>
1.2	Definitions and abbreviations.....	223
2	General description of synchronization system.....	224
3.1	Timing state of the signals.....	224
3.2	Relationship between counters .....	225
4	Timing of transmitted signals.....	225
6	MS Requirements for Synchronization .....	225
6.4	Timing of transmission.....	225
<b>Annex I (normative): Modification to 3GPP TS 24.008 .....</b>		<b>227</b>
1.2	Application to the interface structures.....	227
1.5	Use of logical channels in A/Gb mode.....	227
1.6.1	List of procedures .....	227
1.7.2.1	Packet services in GSM (GSM only) .....	228
2.2.2	Vocabulary.....	229
4.1	General .....	230
4.1.1.1	Types of MM and GMM procedures .....	230
4.1.2.1	MM sublayer states in the mobile station.....	231
4.1.2.1.1	Main states.....	232
4.1.2.1.2	Substates of the MM IDLE state .....	235
4.1.2.2	The update Status .....	236
4.1.2.3	MM sublayer states on the network side.....	236
4.1.3.1	GMM states in the MS .....	237
4.1.3.2	GPRS update status .....	238
4.2.1.2	Other Cases .....	238
4.2.2	Detailed Description of the MS behaviour in MM IDLE State. ....	239
4.2.2.1	Service State, NORMAL SERVICE.....	239
4.2.2.2	Service State, ATTEMPTING TO UPDATE .....	239
4.2.2.3	Service State, LIMITED SERVICE.....	239
4.2.2.4	Service State, NO IMSI.....	240
4.2.2.5	Service State, SEARCH FOR PLMN, NORMAL SERVICE.....	240
4.2.2.6	Service State, SEARCH FOR PLMN .....	240
4.2.3	Service state when back to state MM IDLE from another state.....	240
4.2.4	Behaviour in state GMM-DEREGISTERED.....	241
4.2.4.1.1	Selection of the substate after power on or enabling the MS's GPRS capability.....	241
4.2.4.2.2	Substate, ATTEMPTING-TO-ATTACH .....	242
4.2.4.3	Substate when back to state GMM-DEREGISTERED from another GMM state .....	242
4.2.5.1.1	Substate, NORMAL-SERVICE .....	242
4.2.5.1.4	Substate, ATTEMPTING-TO-UPDATE .....	242

4.2.5.1.7	Substate, ATTEMPTING-TO-UPDATE-MM .....	243
4.3.1	TMSI reallocation procedure .....	243
4.3.1.1	TMSI reallocation initiation by the network .....	243
4.3.1.3	TMSI reallocation completion in the network .....	243
4.3.2b	Authentication Procedure used for a GSM authentication challenge .....	244
4.3.2.1	Authentication request by the network .....	244
4.3.2.2	Authentication response by the mobile station .....	244
4.3.2.3	Authentication processing in the network .....	244
4.3.2.4	Ciphering key sequence number .....	244
4.3.2.5	Authentication not accepted by the network .....	245
4.3.3.3	Abnormal cases .....	245
4.3.4	IMSI detach procedure .....	246
4.3.4.2	IMSI detach procedure in the network .....	246
4.4.1	Location updating procedure .....	246
4.4.2	Periodic updating .....	247
4.4.3	IMSI attach procedure .....	247
4.4.4.1	Location updating initiation by the mobile station .....	248
4.4.4.4	Security mode setting by the network .....	248
4.4.4.8	Release of RR connection after location updating .....	248
4.5	Connection management sublayer service provision .....	248
4.5.1.1	MM connection establishment initiated by the mobile station .....	249
4.5.1.3.1	Mobile Terminating CM Activity .....	250
4.5.1.3.2	Mobile Originating CM Activity \$(CCBS)\$ .....	251
4.5.1.7	Forced release during MO MM connection establishment .....	252
4.7.1.4	Radio resource sublayer address handling .....	252
4.7.1.4.1	Radio resource sublayer address handling (GSM only) .....	252
4.7.2	GPRS Mobility management timers .....	253
4.7.2.2	Periodic routing area updating .....	253
4.7.3	GPRS attach procedure .....	254
4.7.3.1.1	GPRS attach procedure initiation .....	254
4.7.3.1.3	GPRS attach accepted by the network .....	255
4.7.3.1.5	Abnormal cases in the MS .....	255
4.7.3.1.6	Abnormal cases on the network side .....	256
4.7.4	GPRS detach procedure .....	258
4.7.4.1.1	MS initiated GPRS detach procedure initiation .....	258
4.7.4.1.2	MS initiated GPRS detach procedure completion for GPRS services only .....	258
4.7.4.2.2	Network initiated GPRS detach procedure completion by the MS .....	258
4.7.5	Routing area updating procedure .....	260
4.7.5.1	Normal and periodic routing area updating procedure .....	260
4.7.5.1.1	Normal and periodic routing area updating procedure initiation .....	260
4.7.5.1.3	Normal and periodic routing area updating procedure accepted by the network .....	261
4.7.5.1.5	Abnormal cases in the MS .....	261
4.7.5.1.6	Abnormal cases on the network side .....	262
4.7.7b	Authentication and ciphering procedure used for GSM authentication challenge .....	263
4.7.7.1	Authentication and ciphering initiation by the network .....	264
4.7.7.2	Authentication and ciphering response by the MS .....	265
4.7.7.3	Authentication and ciphering completion by the network .....	265
4.7.7.4	GPRS ciphering key sequence number .....	265
4.7.7.7	Use of established security contexts .....	266
4.7.9.1	Paging for GPRS services .....	266
4.7.9.1.1	Paging for GPRS services using P-TMSI .....	266
4.7.9.1.2	Paging for GPRS services using IMSI .....	266
4.7.9.2	Paging for non-GPRS services .....	267
6.1.1	General .....	267
6.1.3.1.1	Successful PDP context activation initiated by the mobile station .....	267
6.1.3.2.1	Successful Secondary PDP Context Activation Procedure Initiated by the MS .....	268
6.1.3.3.1	Network initiated PDP Context Modification .....	268
6.1.3.4.1	PDP context deactivation initiated by the MS .....	268
6.1.3.4.2	PDP context deactivation initiated by the network .....	269
8.1	General .....	269
8.4	Unknown or unforeseen message type .....	269
8.5	Non-semantical mandatory information element errors .....	270



8.7.2	Conditional IE errors .....	271
8.8	Messages with semantically incorrect contents .....	271
9	Message functional definitions and contents .....	271
9.2.2	Authentication request .....	273
9.2.3	Authentication response .....	273
9.2.9	CM service request .....	273
9.2.15	Location updating request .....	274
9.4.9	Authentication and ciphering request .....	274
9.4.10	Authentication and ciphering response .....	275
9.4.10.1	Authentication Response Parameter .....	275
10.1	Overview .....	276
10.3.2	Transaction identifier .....	276
10.4	Message Type .....	277
10.5	Other information elements .....	279
10.5.1.4	Mobile Identity .....	280
10.5.1.6	Mobile Station Classmark 2 .....	282
10.5.1.7	Mobile Station Classmark 3 .....	286
10.5.3.2	Authentication Response parameter .....	292
10.5.3.3	CM service type .....	292
10.5.5.12a	MS Radio Access capability .....	293
11.2.2	Timers of GPRS mobility management .....	297
<b>Annex J (normative): Modification to 3GPP TS 24.011 .....</b>		<b>300</b>
1.2	Abbreviations .....	300
2	Overview of Short Message Service (SMS) support .....	300
2.1	Protocols and protocol architecture .....	300
2.4	Layer 2 (LLC) GPRS support (A/Gb mode only) .....	301
3.2	Service provided by the CM-sublayer .....	301
3.2.1.1	MNSMS-ABORT-REQuest .....	301
3.2.1.4	MNSMS-ESTablish-REQuest .....	302
3.2.1.6	MNSMS-ERROR-INDication .....	302
3.2.1.7	MNSMS-RELease-REQuest .....	302
3.2.2.4	MNSMS-ESTablish-REQuest .....	302
3.2.2.6	MNSMS-ERROR-INDication .....	302
3.2.2.7	MNSMS-RELease-REQuest .....	302
5.1	General .....	302
5.3.4	Abnormal cases .....	302
9.2	CP Error Handling .....	303
<b>Annex A to TS 24.011 (informative): Arrow diagrams .....</b>		<b>304</b>
B.1	Introduction .....	309
History .....		320

---

## Intellectual Property Rights

IPRs essential or potentially essential to the present document may have been declared to ETSI. The information pertaining to these essential IPRs, if any, is publicly available for **ETSI members and non-members**, and can be found in ETSI SR 000 314: "*Intellectual Property Rights (IPRs); Essential, or potentially Essential, IPRs notified to ETSI in respect of ETSI standards*", which is available from the ETSI Secretariat. Latest updates are available on the ETSI Web server (<http://www.etsi.org/legal/home.htm>).

Pursuant to the ETSI IPR Policy, no investigation, including IPR searches, has been carried out by ETSI. No guarantee can be given as to the existence of other IPRs not referenced in ETSI SR 000 314 (or the updates on the ETSI Web server) which are, or may be, or may become, essential to the present document.

---

## Foreword

This ETSI Standard (ES) has been produced by ETSI Project Terrestrial Trunked Radio (TETRA).

---

# 1 Scope

The present document specifies the technical requirements for equipment that supports packet data services and operates in the following TETRA bands:

- TETRA 380: 380-390 MHz Mobile transmit; 390-400 MHz base station transmit;
- TETRA 410: 410-420 MHz Mobile transmit; 420-430 MHz base station transmit;
- TETRA 450: 450-460 MHz Mobile transmit; 460-470 MHz base station transmit;
- TETRA 870: 870-876 MHz Mobile transmit; 915-921 MHz base station transmit.

The technology to be used is that of GSM and the technical requirements are specified by reference to the GSM standards. This specification lists the GSM standards and specifications that apply and specifies which clauses are retained, deleted or amended. The amendments are specified in the annexes of the present document.

The scope of the present document covers the following interfaces, Gi, Gr, Gp and the Air Interface.

The present document supports the following packet data traffic channels:

- PDTCH/F;
- PDTCH/H;
- PDTCH/U;
- PDTCH/D.

It also supports SMS in packet channels and their associated signalling.

All circuit switched channels, including all speech channels are outside the scope of the present document.

NOTE 1: TAPS adapts (E)GPRS technology to provide an overlay network for TETRA systems. TAPS provides high speed packet data at speeds approximately ten times that available in existing TETRA, to support multimedia and other high speed data applications required by existing and future TETRA users.

NOTE 2: TR 101 976 provides an overview description of the principles of TAPS, including a description of the structure of the TAPS specifications.

---

# 2 References

The following documents contain provisions which, through reference in this text, constitute provisions of the present document.

- References are either specific (identified by date of publication and/or edition number or version number) or non-specific.
- For a specific reference, subsequent revisions do not apply.
- For a non-specific reference, the latest version applies.

- [1] 3GPP TR 01.04: "3rd Generation Partnership Project; Abbreviations and acronyms (GSM 01.04 Release 1999)".
- [2] 3GPP TS 02.06: "3rd Generation Partnership Project; Types of Mobile Stations (MS) (GSM 02.06 Release 1998)".
- [3] GSM 02.09: "European digital cellular telecommunications system (Phase 1); Security Aspects (GSM 02.09)".

- [4] 3GPP TS 02.17: "3rd Generation Partnership Project; Subscriber Identity Modules (SIM); (GSM 02.17 Release 1999)".
- [5] ETSI TS 101 413: "Digital cellular telecommunications system (Phase 2+) (GSM); Subscriber Identity Module Application Programming Interface (SIM API); Service description; Stage 1 (GSM 02.19 Release 1998)".
- [6] ETSI TS 101 107: "Digital cellular telecommunications system (Phase 2+); Fraud Information Gathering System (FIGS); Service description - Stage 1 (GSM 02.31 Release 1999)".
- [7] ETSI TS 101 749: "Digital cellular telecommunications system (Phase 2+); Immediate Service Termination (IST) Service description - Stage 1 (GSM 02.32 Release 1999)".
- [8] GSM 02.33: "Digital cellular telecommunications system (Phase 2+); Lawful Interception - Stage 1 (GSM 02.33, Release 1999)".
- [9] ETSI TS 101 180: "Digital cellular telecommunications system (Phase 2+) (GSM); Security mechanisms for the SIM application toolkit; Stage 1 (GSM 02.48 Release 1999)".
- [10] ETSI TS 100 927 (3GPP TS 03.03): "3rd Generation Partnership Project; Numbering, addressing and identification (GSM 03.03 Release 1998)".
- [11] 3GPP TS 03.13: "3rd Generation Partnership Project; Discontinuous Reception (DRX) in the GSM system (GSM 03.13 Release 1999)".
- [12] 3GPP TS 03.20: "3rd Generation Partnership Project; Security related network functions (GSM 03.20 Release 1999)".
- [13] 3GPP TS 03.22: "3rd Generation Partnership Project; Functions related to Mobile Station (MS) in idle mode and group receive mode; (GSM 03.22 Release 1999)".
- [14] ETSI TR 101 266: "Digital cellular telecommunications system (Phase 2+) (GSM); Multiband operation of GSM/DCS 1 800 by a single operator (GSM 03.26 Release 1999)".
- [15] 3GPP TR 03.30: "3rd Generation Partnership Project; Radio network planning aspects (GSM 03.30 Release 1999)".
- [16] GSM 03.31: "Digital cellular telecommunications system (Phase 2+); Fraud Information Gathering System (FIGS); Technical realization - Stage 2 (GSM 03.31 Release 1999)".
- [17] 3GPP TS 03.33: "3rd Generation Partnership Project; Lawful interception; Stage 2 (GSM 03.33 Release 1999)".
- [18] GSM 03.35: "Digital cellular telecommunications system (Phase 2+); Immediate Service Termination (IST) Stage 2 (GSM 03.35, Release 99)".
- [19] GSM 03.38: "Digital cellular telecommunications system (Phase 2+) (GSM); Alphabets and language-specific information (GSM 03.38 Release 1998)".
- [20] 3GPP TS 03.48: "3rd Generation Partnership Project; Security Mechanisms for the SIM application toolkit; (GSM 03.48, Release 1999)".
- [21] 3GPP TS 03.52: "3rd Generation Partnership Project; GSM Cordless Telephony System (CTS), Phase 1; Lower Layers of the CTS Radio Interface; Stage 2; (GSM 03.52 Release 1999)".
- [22] 3GPP TS 03.64: "3rd Generation Partnership Project; General Packet Radio Service (GPRS); Overall description of the GPRS radio interface; (GSM 03.64 Release 1999)".
- [23] GSM 03.71: "Digital cellular telecommunications system (Phase 2+); Location Services (LCS); (Functional description); Stage 2 (GSM 03.71 Release 1999)".
- [24] ETSI TS 100 550: "Digital cellular telecommunications system (Phase 2+) (GSM); Mobile Station - Base Station System (MS - BSS) interface; General aspects and principles (GSM 04.01 Release 1999)".

- [25] GSM 04.03: "Digital cellular telecommunications system (Phase 2+); Mobile Station - Base Station System (MS - BSS) interface; Channel structures and access capabilities (GSM 04.03 Release 1999)".
- [26] 3GPP TS 04.04: "3rd Generation Partnership Project; Layer 1; General requirements (GSM 04.04 Release 1999)".
- [27] ETSI EN 300 937: "Digital cellular telecommunications system (Phase 2+) (GSM); Data Link (DL) layer; General aspects (GSM 04.05 Release 1999)".
- [28] ETSI EN 300 938: "Digital cellular telecommunications system (Phase 2+) (GSM); Mobile Station - Base Station System (MS - BSS) interface; Data Link (DL) layer specification (GSM 04.06 Release 1999)".
- [29] 3GPP TS 04.08: "3rd Generation Partnership Project; Mobile radio interface layer 3 specification (GSM 04.08 Release 1999)".
- [30] GSM 04.13: "Digital cellular telecommunications system (Phase 2+) (GSM); Performance requirements on the mobile radio interface (GSM 04.13)".
- [31] GSM 04.14: "Digital cellular telecommunications system (Phase 2+) (GSM); Individual equipment type requirements and interworking; Special conformance testing functions (GSM 04.14 Release 1999)".
- [32] 3GPP TS 04.18: "3rd Generation Partnership Project; Mobile radio interface layer 3 specification; Radio Resource Control Protocol (Release 1999)".
- [33] 3GPP TS 04.21: "3rd Generation Partnership Project; Rate adaption on the Mobile Station - Base Station System (MS - BSS) Interface (GSM 04.21 Release 1999)".
- [34] 3GPP TS 04.31: "3rd Generation Partnership Project; Location Services (LCS); Mobile Station (MS) - Serving Mobile Location Centre (SMLC) Radio Resource LCS Protocol (RRLP) (GSM 04.31 Release 1999)".
- [35] 3GPP TS 04.35: "3rd Generation Partnership Project; Location Services (LCS); Broadcast Network Assistance for Enhanced Observed Time Difference (E-OTD) and Global Positioning System (GPS) Positioning Methods (Release 1999)".
- [36] 3GPP TS 04.60: "3rd Generation Partnership Project; Technical Specification Group GSM/EDGE Radio Access Network; General Packet Radio Service (GPRS); Mobile Station (MS) - Base Station System (BSS) interface; Radio Link Control/Medium Access Control (RLC/MAC) protocol (GSM 04.60 Release 1999)".
- [37] 3GPP TS 04.64: "3rd Generation Partnership Project; General Packet Radio Service (GPRS); Mobile Station - Serving GPRS Support Node (MS-SGSN) Logical Link Control (LLC) layer specification (GSM 04.64 Release 1999)".
- [38] 3GPP TS 04.65: "3rd Generation Partnership Project; General Packet Radio Service (GPRS); Mobile Station (MS) - Serving GPRS Support Node (SGSN); Subnetwork Dependent Convergence Protocol (SNDP) (GSM 04.65 Release 1999)".
- [39] ETSI TS 101 725: "Digital cellular telecommunications system (Phase 2+) (GSM); Location Services (LCS); Mobile radio interface layer 3 Location Services (LCS) specification (GSM 04.71 Release 1999)".
- [40] GSM 05.01: "European digital cellular telecommunications system (Phase 1); Physical Layer on the Radio Path (General Description) (GSM 05.01)".
- [41] 3GPP TS 05.02: "3rd Generation Partnership Project; Multiplexing and multiple access on the radio path (GSM 05.02 Release 1999)".
- [42] 3GPP TS 05.03: "3rd Generation Partnership Project; Channel coding (GSM 05.03 Release 1999)".
- [43] 3GPP TS 05.04: "3rd Generation Partnership Project; Modulation (GSM 05.04 Release 1999)".

- [44] 3GPP TS 05.05: "3rd Generation Partnership Project; Radio transmission and reception (GSM 05.05 Release 1999)".
- [45] 3GPP TS 05.08: "3rd Generation Partnership Project; Technical Specification Group GSM/EDGE Radio Access Network; Radio subsystem link control (Release 1999)".
- [46] 3GPP TS 05.10: "3rd Generation Partnership Project; Radio subsystem synchronization (GSM 05.10 Release 1999)".
- [47] ETSI TS 100 587: "Digital cellular telecommunications system (Phase 2+) (GSM); Base Station System - Mobile-services Switching Centre (BSS - MSC) interface; General aspects (GSM 08.01 Release 1999)".
- [48] GSM 08.02: "Digital cellular telecommunications system (Phase 2+) (GSM); Base Station System - Mobile-services Switching Centre (BSS - MSC) interface; Interface principles (GSM 08.02)".
- [49] ETSI TS 100 588: "Digital cellular telecommunications system (Phase 2+) (GSM); Base Station System - Mobile-services Switching Centre (BSS - MSC) interface Layer 1 specification (GSM 08.04 Release 1999)".
- [50] ETSI TS 100 589: "Digital cellular telecommunications system (Phase 2+) (GSM); Signalling transport mechanism specification for the Base Station System - Mobile-services Switching Centre (BSS - MSC) interface (GSM 08.06 Release 1999)".
- [51] 3GPP TS 08.08: "3rd Generation Partnership Project; Mobile-services Switching Centre - Base Station System (MSC - BSS) interface; (Release 1999)".
- [52] ETSI TS 101 298: "Digital cellular telecommunications system (Phase 2+) (GSM); General Packet Radio Service (GPRS); Base Station System (BSS) - Serving GPRS Support Node (SGSN) interface; Gb interface Layer 1 (GSM 08.14 Release 1999)".
- [53] ETSI TS 101 299: "Digital cellular telecommunications system (Phase 2+) (GSM); General Packet Radio Service (GPRS); Base Station System (BSS) - Serving GPRS Support Node (SGSN) interface; Network Service (GSM 08.16 Release 1999)".
- [54] 3GPP TS 08.18: "3rd Generation Partnership Project; General Packet Radio Service (GPRS); Base Station System (BSS) - Serving GPRS Support Node (SGSN); BSS GPRS Protocol (BSSGP) (GSM 08.18 Release 1999)".
- [55] ETSI TS 101 529: "Digital cellular telecommunications system (Phase 2+) (GSM); Location Services (LCS); Serving Mobile Location Centre - Serving Mobile Location Centre (SMLC - SMLC); SMLCPP specification (GSM 08.31 Release 1999)".
- [56] GSM 08.52: "Digital cellular telecommunications system; Base Station Controller - Base Transceiver Station (BSC - BTS) interface; Interface principles (GSM 08.52)".
- [57] ETSI TS 100 594: "Digital cellular telecommunications system (Phase 2+) (GSM); Base Station Controller - Base Transceiver Station (BSC - BTS) interface; Layer 1 structure of physical circuits (GSM 08.54 Release 1999)".
- [58] ETSI TS 100 595: "Digital cellular telecommunications system (Phase 2+) (GSM); Base Station Controller - Base Transceiver Station (BSC - BTS) interface; Layer 2 specification (GSM 08.56 Release 1999)".
- [59] 3GPP TS 08.58: "3rd Generation Partnership Project; Technical Specification Group GSM EDGE Radio Access Network; Base Station Controller - Base Transceiver Station (BSC - BTS) interface; Layer 3 specification (Release 1999)".
- [60] 3GPP TS 08.71: "3rd Generation Partnership Project; Serving Mobile Location Centre - Base Station System (SMLC-BSS) interface; Layer 3 specification (GSM 08.71 Release 1999)".
- [61] GSM 09.01: "Digital cellular telecommunications system (Phase 2+) (GSM); General network interworking scenarios (GSM 09.01 Release 1999)".

- [62] 3GPP TS 09.08: "3rd Generation Partnership Project; Technical Specification Group Core Network; Digital cellular telecommunications system (Phase 2+); Application of the Base Station System Application Part (BSSAP) on the E-interface (Release 1999)".
- [63] 3GPP TS 09.31: "3rd Generation Partnership Project; Location Services (LCS); Base Station System Application Part LCS Extension (BSSAP-LE) (GSM 09.31 Release 1999)".
- [64] 3GPP TS 11.11: "3rd Generation Partnership Project; Specification of the Subscriber Identity Module - Mobile Equipment (SIM - ME) interface (GSM 11.11 Release 1999)".
- [65] ETSI ETS 300 641: "Digital cellular telecommunications system (Phase 2) (GSM); Specification of the 3 Volt Subscriber Identity Module - Mobile Equipment (SIM - ME) interface (GSM 11.12)".
- [66] 3GPP TS 11.14: "3rd Generation Partnership Project; Specification of the SIM Application Toolkit for the Subscriber Identity Module - Mobile Equipment (SIM - ME) interface (GSM 11.14 Release 1999)".
- [67] ETSI EN 300 086: "Digital cellular telecommunications system (Phase 2+) Subscriber Identity Module (SIM) conformance test specification (GSM 11.17 Release 1998)".
- [68] ETSI TS 101 116: "Digital cellular telecommunications system (Phase 2+) (GSM); Specification of the 1.8 Volt Subscriber Identity Module - Mobile Equipment (SIM - ME) interface (GSM 11.18 Release 1998)".
- [69] ETSI TS 100 614: "Digital cellular telecommunications system (Phase 2+) (GSM); Security management (GSM 12.03 Release 1999)".
- [70] ETSI TS 100 615: "Digital cellular telecommunications system (Phase 2+) (GSM); Performance data measurements (GSM 12.04 Release 1999)".
- [71] ETSI TS 101 513: "Digital cellular telecommunications system (Phase 2+) (GSM); Location Services (LCS); Location services management (GSM 12.71 Release 1999)".
- [72] 3GPP TR 21.905: "3rd Generation Partnership Project; Technical Specification Group Services and System Aspects Service aspects; 3G Vocabulary (Release 1999)".
- [73] 3GPP TS 22.011: "3rd Generation Partnership Project; Technical Specification Group Services and System Aspects (SA); Service accessibility (3G TS 22.011 Release 1999)".
- [74] 3GPP TS 22.016: "3rd Generation Partnership Project; Technical Specification Group Services and System Aspects; International Mobile Equipment Identities (IMEI) (Release 1999)".
- [75] 3GPP TS 22.022: "3rd Generation Partnership Project; Universal Mobile Telecommunications System (UMTS); Personalisation of GSM Mobile Equipment (ME); Mobile functionality specification (Release 1999)".
- [76] 3GPP TS 22.030: "3rd Generation Partnership Project; Technical Specification Group Services and System Aspects; Man-Machine Interface (MMI) of the User Equipment (UE) (Release 1999)".
- [77] 3GPP TS 22.038: "3rd Generation Partnership Project; Technical Specification Group Services and System Aspects; USIM/SIM Application Toolkit (USAT/SAT); Service description; Stage 1 (3GPP TS 22.038 Release 1999)".
- [78] 3GPP TS 22.043: "3rd Generation Partnership Project; Universal Mobile Telecommunications System (UMTS); Support of Localised Service Area (SoLSA) Service description; Stage 1 (3G TS 22.043)".
- [79] 3GPP TS 22.057: "3rd Generation Partnership Project; Universal Mobile Telecommunications System (UMTS); Mobile Station Application Execution Environment (MExE); Service description; Stage 1 (3G TS 22.057 Release 1999)".
- [80] 3GPP TS 22.060: "3rd Generation Partnership Project; Technical Specification Group Services and System Aspects (SA); General Packet Radio Service (GPRS); Service description; Stage 1 (Release 1999)".

- [81] 3GPP TS 22.071: "3rd Generation Partnership Project; Technical Specification Group Systems Aspects; Location Services (LCS); Stage 1 (Release 1999)".
- [82] 3GPP TS 22.078: "3rd Generation Partnership Project; Technical Specification Group Services and System Aspects; Customised Applications for Mobile network Enhanced Logic (CAMEL); Service definition; Stage 1 (Release 1999)".
- [83] 3GPP TS 23.002: "3rd Generation Partnership Project; Technical Specification Group Services and System Aspects; Network architecture (Release 1999)".
- [84] 3GPP TS 23.003: "3rd Generation Partnership Project; Technical Specification Group Core Network Numbering, addressing and identification (Release 1999)".
- [85] 3GPP TS 23.007: "3rd Generation Partnership Project; Universal Mobile Telecommunications System (UMTS); Restoration procedures (3G TS 23.007 Release 1999)".
- [86] 3GPP TS 23.008: "3rd Generation Partnership Project; Technical Specification Group Core Network; Organization of subscriber data (Release 1999)".
- [87] 3GPP TS 23.012: "3rd Generation Partnership Project; Universal Mobile Telecommunications System (UMTS); Location Management Procedures (3G TS 23.012)".
- [88] 3GPP TS 23.016: "3rd Generation Partnership Project; Technical Specification Group Core Network; Subscriber data management; Stage 2 (Release 1999)".
- [89] 3GPP TS 23.032: "3rd Generation Partnership Project; Universal Mobile Telecommunications System (UMTS); Universal Geographical Area Description (GAD) (3G TS 23.032 Release 1999)".
- [90] 3GPP TS 23.038: "3rd Generation Partnership Project; Universal Mobile Telecommunications System (UMTS); Short Message Service (SMS) Cell Broadcast Service (CBS); Alphabets and language-specific information (3G TS 23.038 Release 1999)".
- [91] 3GPP TS 23.039: "3rd Generation Partnership Project; Universal Mobile Telecommunications System (UMTS); Interface protocols for the connection of Short Message Service Centres (SMSCs) to Short Message Entities (SMEs) (3G TR 23.039 Release 1999)".
- [92] 3GPP TS 23.040: "3rd Generation Partnership Project; Technical realization of the Short Message Service (SMS) (3G TS 23.040 Release 1999)".
- [93] 3GPP TS 23.041: "3rd Generation Partnership Project; Technical Specification Group Terminals; Technical realization of Cell Broadcast Service (CBS) (Release 1999)".
- [94] 3GPP TS 23.042: "3rd Generation Partnership Project; Technical Specification Group Terminals; Compression algorithm for text messaging services (Release 1999)".
- [95] 3GPP TS 23.057: "3rd Generation Partnership Project; Universal Mobile Telecommunications System (UMTS); Mobile Station Application Execution Environment (MEExE); Functional description; Stage 2 (Release 1999)".
- [96] 3GPP TS 23.060: "3rd Generation Partnership Project; Universal Mobile Telecommunications System (UMTS); General Packet Radio Service (GPRS); Service description; Stage 2 (3G TS 23.060 Release 1999)".
- [97] 3GPP TS 23.073: "3rd Generation Partnership Project; Technical Specification Group Core Network; Support of Localised Service Area (SoLSA); Stage 2 (3G TS 23.073 Release 1999)".
- [98] 3GPP TS 23.078: "3rd Generation Partnership Project; Technical Specification Group Core Network; Customised Applications for Mobile network Enhanced Logic (CAMEL) - stage 2; (Release 1999)".
- [99] 3GPP TS 24.007: "3rd Generation Partnership Project; Technical Specification Group Core Network; Mobile radio interface signalling layer 3; General aspects (Release 1999)".



- [100] 3GPP TS 24.008: "3rd Generation Partnership Project; Technical Specification Group Core Network; Mobile radio interface layer 3 specification; Core Network Protocols - Stage 3 (Release 1999)".
- [101] 3GPP TS 24.010: "3rd Generation Partnership Project; Technical Specification Group Core Network; Mobile radio interface layer 3; Supplementary services specification; General aspects (3G TS 24.010)".
- [102] 3GPP TS 24.011: "3rd Generation Partnership Project; Technical Specification Group Core Network; Point-to-Point (PP) Short Message Service (SMS) support on mobile radio interface (Release 1999)".
- [103] 3GPP TS 24.012: "3rd Generation Partnership Project; Technical Specification Group Core Network; Short Message Service Cell Broadcast (SMSCB) Support on the Mobile Radio Interface (3G TS 24.012)".
- [104] 3GPP TS 24.030: "3rd Generation Partnership Project; Technical Specification Group Core Network; Location Services LCS Stage 3 SS (MO-LR) (3G TS 24.030 Release 1999)".
- [105] 3GPP TS 27.005: "3rd Generation Partnership Project; Technical Specification Group Terminals; Use of Data Terminal Equipment - Data Circuit terminating Equipment (DTE - DCE) interface for Short Message Service (SMS) and Cell Broadcast Service (CBS) (3G TS 27.005)".
- [106] 3GPP TS 27.007: "3rd Generation Partnership Project; Technical Specification Group Terminals; AT command set for User Equipment (UE) (Release 1999)".
- [107] 3GPP TS 27.010: "3rd Generation Partnership Project; Technical Specification Group Terminals; Terminal Equipment to User Equipment (TE-UE) multiplexer protocol User Equipment (UE) (3G TS 27.010 Release 1999)".
- [108] 3GPP TS 27.060: "3rd Generation Partnership Project; Technical Specification Group Core Network; GPRS Mobile Stations supporting GPRS (3G TS 27.060 Release 1999)".
- [109] 3GPP TS 29.002: "3rd Generation Partnership Project; Technical Specification Group Core Network; Mobile Application Part (MAP) specification (Release 1999)".
- [110] 3GPP TS 29.006: "Digital cellular telecommunications system (Phase 2+) (GSM); Universal Mobile Telecommunications System (UMTS); Interworking between the Public Land Mobile Network (PLMN) and a Packet Switched Public Data Network/Integrated Services Digital Network (PSPDN/ISDN) for the support of packet switched data transmission services (3G TS 29.006 Release 1999)".
- [111] 3GPP TS 29.010: "3rd Generation Partnership Project; Technical Specification Group Core Network; Information element mapping between Mobile Station - Base Station System (MS - BSS) and Base Station System - Mobile-services Switching Centre (BSS - MSC); Signalling procedures and the Mobile Application Part (MAP) (Release 1999)".
- [112] 3GPP TS 29.016: "3rd Generation Partnership Project; Technical Specification Group Core Network; GPRS, Serving GPRS Support Node (SGSN); Visitors Location Register (VLR); Gs Interface Network Service Specification (3G TS 29.016 Release 1999)".
- [113] 3GPP TS 29.018: "3rd Generation Partnership Project; Technical Specification Group Core Network; GPRS, Serving GPRS Support Node (SGSN); Visitors Location Register (VLR); Gs Interface Layer 3 Specification (Release 1999)".
- [114] 3GPP TS 29.060: "3rd Generation Partnership Project; Technical Specification Group Core Network; GPRS Tunnelling Protocol (GTP) across the Gn and Gp Interface (Release 1999)".
- [115] 3GPP TS 29.061: "3rd Generation Partnership Project; Technical Specification Group Core Network; Inter-working between the Public Land Mobile Network (PLMN) supporting GPRS and Packet Data Networks (PDN) (Release 1999)".
- [116] 3GPP TS 29.078: "3rd Generation Partnership Project; Technical Specification Group Core Network; Customized Applications for Mobile network Enhanced Logic (CAMEL) Phase 3 CAMEL Application Part (CAP) specification (Release 1999)".

- [117] ETSI TS 131 102: "Universal Mobile Telecommunications System (UMTS); Characteristics of the USIM Application (3GPP TS 31.102 Release 1999)".
- [118] 3GPP TS 32.015: "3rd Generation Partnership Project; Technical Specification Group Services and System Aspects; 3G call and event data for the Packet Switched (PS) domain (Release 1999)".
- [119] ETSI TR 101 976: "Terrestrial Trunked Radio (TETRA); Guide to TETRA Advanced Packet Service (TAPS)".
- [120] ITU-T Recommendation O.153: "Basic parameters for the measurement of error performance at bit rates below the primary rate".
- [121] ITU-T Recommendation Q.931: "ISDN user-network interface layer 3 specification for basic call control".
- [122] ITU-T Recommendation V.25ter: "Serial asynchronous automatic dialling and control".

## 3 Definitions and abbreviations

### 3.1 Definitions

For the purposes of the present document, the following terms and definitions apply:

**air interface:** interface between Mobile Station and Base Station System

**Gi interface:** interface between Packet Domain and an external packet data network

**Gp interface:** interface between two GPRS Support Nodes (GSNs) in different PLMNs

**Gr interface:** interface between the Serving GPRS Support Node and the Home Location Register

### 3.2 Abbreviations

For the purposes of the present document, the following abbreviation applies:

TAPS                      TETRA Advanced Packet Service

## 4 TAPS requirements

Clause 4.1 lists the specifications which are applicable to TAPS, in part or in whole.

For those standards which are applicable in part, clauses 4.2 to 4.30 indicate which clauses from these standards are applicable.

In the tables included in clauses 4.2 to 4.30, the term "N/A" indicates that a clause is not applicable to TAPS. A reference to an annex indicates that the annex contains a modification to the clause for the purposes of applying the clause to TAPS.

Where individual clauses have been modified to make them applicable to TAPS, the modifications are shown in annex A to annex I. So that it is clear what changes have been made, text coloured red and formatted with strikethrough indicates text deleted from the clause, while text coloured blue and formatted with underline indicates text added to the clause.

For the purpose of the present document, the scope of the requirements in the referenced specifications shall be taken to apply to terminals and networks within the scope of the present document.

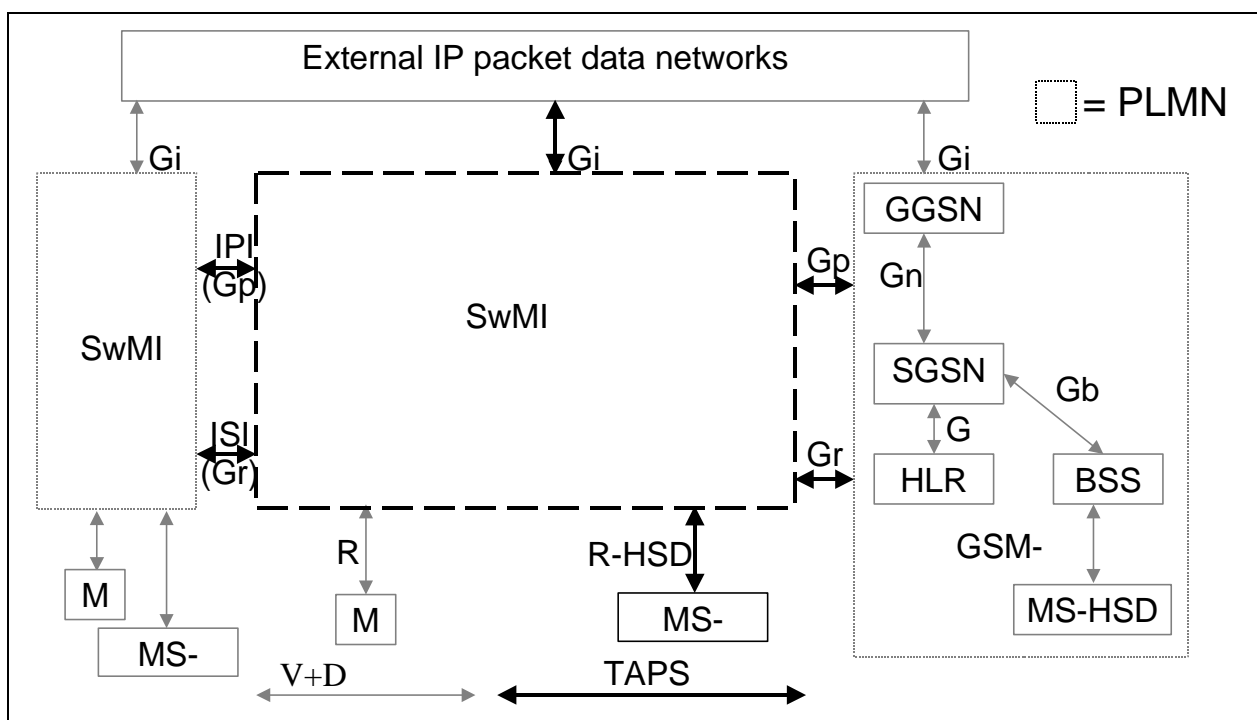

Figure 1: TAPS Interfaces

## 4.1 Applicable 3GPP specifications

The 3GPP specifications that are applicable to TAPS are listed in table 1. Where the applicability column shows "Y", then the whole of the specification is applicable. Where the applicability column gives a reference to another clause, that clause describes the parts of the specification that are applicable.

Table 1: Applicable 3GPP specifications

Title	Applicability
GSM 02.09: "European digital cellular telecommunications system (Phase 1); Security Aspects (GSM 02.09)".	Y
3GPP TS 02.17: "European digital cellular telecommunications system (Phase 1); Subscriber Identity Modules, Functional Characteristics (GSM 02.17)".	Y
ETSI TS 101 413: "Digital cellular telecommunications system (Phase 2+) (GSM); Subscriber Identity Module Application Programming Interface (SIM API); Service description; Stage 1 (GSM 02.19 Release 1998)".	Y
ETSI TS 101 107: "Digital cellular telecommunications system (Phase 2+); Fraud Information Gathering System (FIGS); Service description - Stage 1 (GSM 02.31 Release 1999)".	Y
ETSI TS 101 749: "Digital cellular telecommunications system (Phase 2+); Immediate Service Termination (IST) Service description - Stage 1 (GSM 02.32 Release 1999)".	Y
GSM 02.33: "Digital cellular telecommunications system (Phase 2+); Lawful Interception - stage 1 (GSM 02.33, Release 1999)".	Y
ETSI TS 101 180: "Digital cellular telecommunications system (Phase 2+) (GSM); Security mechanisms for the SIM application toolkit; Stage 1 (GSM 02.48 Release 1999)".	Y
3GPP TS 03.20: "3rd Generation Partnership Project; Security related network functions (GSM 03.20 Release 1999)".	Y
3GPP TS 03.22: "3rd Generation Partnership Project; Functions related to Mobile Station (MS) in idle mode and group receive mode; (GSM 03.22 Release 1999)".	See 4.2
ETSI TR 101 266: "Digital cellular telecommunications system (Phase 2+) (GSM); Multiband operation of GSM/DCS 1 800 by a single operator (GSM 03.26 Release 1999)".	Y
GSM 03.31: "Digital cellular telecommunications system (Phase 2+); Fraud Information Gathering System (FIGS); Technical realization - Stage 2 (GSM 03.31 Release 1999)".	Y
3GPP TS 03.33: "3rd Generation Partnership Project; Lawful interception; Stage 2 (GSM 03.33 Release 1999)".	See 4.3
GSM 03.35: "Digital cellular telecommunications system (Phase 2+); Immediate Service Termination (IST) Stage 2 (GSM 03.35, Release 99)".	Y

Title	Applicability
3GPP TS 03.48: "3rd Generation Partnership Project; Security Mechanisms for the SIM application toolkit; (GSM 03.48, Release 1999)".	Y
3GPP TS 03.64: "3rd Generation Partnership Project; General Packet Radio Service (GPRS); Overall description of the GPRS radio interface; (GSM 03.64 Release 1999)".	Y
GSM 03.71: "Digital cellular telecommunications system (Phase 2+); Location Services (LCS); (Functional description) - Stage 2 (GSM 03.71 Release 1999)".	Y
ETSI TS 100 550: "Digital cellular telecommunications system (Phase 2+) (GSM); Mobile Station - Base Station System (MS - BSS) interface; General aspects and principles (GSM 04.01 Release 1999)".	Y
GSM 04.03: "Digital cellular telecommunications system (Phase 2+); Mobile Station - Base Station System (MS - BSS) interface; Channel structures and access capabilities (GSM 04.03 Release 1999)".	Y
3GPP TS 04.04: "Digital cellular telecommunications system (Phase 2+); Layer 1; General requirements (GSM 04.04 Release 1999)".	Y
ETSI EN 300 937: "Digital cellular telecommunications system (Phase 2+) (GSM); Data Link (DL) layer; General aspects (GSM 04.05 Release 1999)".	Y
ETSI EN 300 938: "Digital cellular telecommunications system (Phase 2+) (GSM); Mobile Station - Base Station System (MS - BSS) interface; Data Link (DL) layer specification (GSM 04.06 Release 1999)".	Y
GSM 04.13: "Digital cellular telecommunications system (Phase 2+) (GSM); Performance requirements on the mobile radio interface (GSM 04.13)".	See 4.4
GSM 04.14: "Digital cellular telecommunications system (Phase 2+) (GSM); Individual equipment type requirements and interworking; Special conformance testing functions (GSM 04.14 Release 1999)".	See 4.5
3GPP TS 04.18: "3rd Generation Partnership Project; Mobile radio interface layer 3 specification; Radio Resource Control Protocol (Release 1999)".	See 4.6
3GPP TS 04.31: "3rd Generation Partnership Project; Location Services (LCS); Mobile Station (MS) - Serving Mobile Location Centre (SMLC) Radio Resource LCS Protocol (RRLP) (GSM 04.31 Release 1999)".	Y
3GPP TS 04.35: "3rd Generation Partnership Project; Location Services (LCS); Broadcast Network Assistance for Enhanced Observed Time Difference (E-OTD) and Global Positioning System (GPS) Positioning Methods (Release 1999)".	Y
3GPP TS 04.60: "3rd Generation Partnership Project; Technical Specification Group GSM/EDGE Radio Access Network; General Packet Radio Service (GPRS); Mobile Station (MS) - Base Station System (BSS) interface; Radio Link Control/Medium Access Control (RLC/MAC) protocol (Release 1999)".	See 4.7
3GPP TS 04.64: "3rd Generation Partnership Project; General Packet Radio Service (GPRS); Mobile Station - Serving GPRS Support Node (MS-SGSN) Logical Link Control (LLC) layer specification (GSM 04.64 Release 1999)".	Y
3GPP TS 04.65: "3rd Generation Partnership Project; General Packet Radio Service (GPRS); Mobile Station (MS) - Serving GPRS Support Node (SGSN); Subnetwork Dependent Convergence Protocol (SNDP) (GSM 04.65 Release 1999)".	Y
ETSI TS 101 725: "Digital cellular telecommunications system (Phase 2+) (GSM); Location Services (LCS); Mobile radio interface layer 3 Location Services (LCS) specification (GSM 04.71 Release 1999)".	Y
GSM 05.01: "Digital cellular telecommunications system (Phase 2+) (GSM); Physical layer on the radio path; General description (GSM 05.01)".	See 4.8
3GPP TS 05.02: "3rd Generation Partnership Project; Multiplexing and multiple access on the radio path (GSM 05.02 Release 1999)".	See 4.9
3GPP TS 05.03: "3rd Generation Partnership Project; Channel coding (GSM 05.03 Release 1999)".	See 4.10
3GPP TS 05.04: "3rd Generation Partnership Project; Modulation (GSM 05.04 Release 1999)".	Y
3GPP TS 05.05: "3rd Generation Partnership Project; Radio transmission and reception (GSM 05.05 Release 1999)".	See 4.11
3GPP TS 05.08: "3rd Generation Partnership Project; Technical Specification Group GSM/EDGE Radio Access Network; Radio subsystem link control (Release 1999)".	See 4.12
3GPP TS 05.10: "3rd Generation Partnership Project; Radio subsystem synchronization (GSM 05.10 Release 1999)".	See 4.13
ETSI TS 100 587: "Digital cellular telecommunications system (Phase 2+); Base Station System - Mobile-services Switching Centre (BSS - MSC) interface; General aspects (GSM 08.01 Release 1999)".	Y
ETSI TS 101 642: "Digital cellular telecommunications system (Phase 2+) (GSM); Base Station System - Mobile-services Switching Centre (BSS - MSC) interface; Interface principles (GSM 08.02 Release 1999)".	See 4.14

Title	Applicability
ETSI TS 100 588: "Digital cellular telecommunications system (Phase 2+) (GSM); Base Station System - Mobile-services Switching Centre (BSS - MSC) interface Layer 1 specification (GSM 08.04 Release 1999)".	Y
ETSI TS 100 589: "Digital cellular telecommunications system (Phase 2+) (GSM); Signalling transport mechanism specification for the Base Station System - Mobile-services Switching Centre (BSS - MSC) interface (GSM 08.06 Release 1999)".	Y
3GPP TS 08.08: "3rd Generation Partnership Project; Mobile-services Switching Centre - Base Station System (MSC - BSS) interface; (Release 1999)".	See 4.15
ETSI TS 101 298: "Digital cellular telecommunications system (Phase 2+) (GSM); General Packet Radio Service (GPRS); Base Station System (BSS) - Serving GPRS Support Node (SGSN) interface; Gb interface Layer 1 (GSM 08.14 Release 1999)".	Y
ETSI TS 101 299: "Digital cellular telecommunications system (Phase 2+) (GSM); General Packet Radio Service (GPRS); Base Station System (BSS) - Serving GPRS Support Node (SGSN) interface; Network Service (GSM 08.16 Release 1999)".	Y
3GPP TS 08.18: "3rd Generation Partnership Project; General Packet Radio Service (GPRS); Base Station System (BSS) - Serving GPRS Support Node (SGSN); BSS GPRS Protocol (BSSGP) (GSM 08.18 Release 1999)".	Y
ETSI TS 101 529: "Digital cellular telecommunications system (Phase 2+) (GSM); Location Services (LCS); Serving Mobile Location Centre - Serving Mobile Location Centre (SMLC - SMLC); SMLCPP specification (GSM 08.31 Release 1999)".	Y
ETSI TS 100 593: "Digital cellular telecommunications system (Phase 2+) (GSM); Base Station Controller - Base Transceiver Station (BSC - BTS) interface; Interface principles (GSM 08.52 Release 1999)".	See 4.16
ETSI TS 100 594: "Digital cellular telecommunications system (Phase 2+) (GSM); Base Station Controller - Base Transceiver Station (BSC - BTS) interface; Layer 1 structure of physical circuits (GSM 08.54 Release 1999)".	Y
ETSI TS 100 595: "Digital cellular telecommunications system (Phase 2+) (GSM); Base Station Controller - Base Transceiver Station (BSC - BTS) interface; Layer 2 specification (GSM 08.56 Release 1999)".	Y
3GPP TS 08.58: "3rd Generation Partnership Project; Technical Specification Group GSM EDGE Radio Access Network; Base Station Controller - Base Transceiver Station (BSC - BTS) interface; Layer 3 specification (Release 1999)".	See 4.17
3GPP TS 08.71: "3rd Generation Partnership Project; Serving Mobile Location Centre - Base Station System (SMLC-BSS) interface; Layer 3 specification (GSM 08.71 Release 1999)".	Y
ETSI TR 101 643: "Digital cellular telecommunications system (Phase 2+) (GSM); General network interworking scenarios (GSM 09.01 Release 1999)".	Y
3GPP TS 09.08: "3rd Generation Partnership Project; Technical Specification Group Core Network; Digital cellular telecommunications system (Phase 2+); Application of the Base Station System Application Part (BSSAP) on the E-interface (Release 1999)".	Y
3GPP TS 09.31: "3rd Generation Partnership Project; Location Services (LCS); Base Station System Application Part LCS Extension (BSSAP-LE) (GSM 09.31 Release 1999)".	Y
3GPP TS 11.11: "3rd Generation Partnership Project; Specification of the Subscriber Identity Module - Mobile Equipment (SIM - ME) interface (GSM 11.11 Release 1999)".	See 4.18
ETSI TS 300 641: "Digital cellular telecommunications system (Phase 2) (GSM); Specification of the 3 Volt Subscriber Identity Module - Mobile Equipment (SIM - ME) interface (GSM 11.12)".	Y
3GPP TS 11.14: "3rd Generation Partnership Project; Specification of the SIM Application Toolkit for the Subscriber Identity Module - Mobile Equipment (SIM - ME) interface (GSM 11.14 Release 1999)".	See 4.19
ETSI EN 300 086: "Digital cellular telecommunications system (Phase 2+) Subscriber Identity Module (SIM) conformance test specification (GSM 11.17 Release 1998)".	Y
ETSI TS 101 116: "Digital cellular telecommunications system (Phase 2+) (GSM); Specification of the 1.8 Volt Subscriber Identity Module - Mobile Equipment (SIM - ME) interface (GSM 11.18 Release 1998)".	Y
ETSI TS 100 614: "Digital cellular telecommunications system (Phase 2+) (GSM); Security management (GSM 12.03 Release 1999)".	Y
ETSI TS 100 615: "Digital cellular telecommunications system (Phase 2+) (GSM); Performance data measurements (GSM 12.04 Release 1999)".	Y
ETSI TS 101 513: "Digital cellular telecommunications system (Phase 2+) (GSM); Location Services (LCS); Location services management (GSM 12.71 Release 1999)".	Y
3GPP TS 22.011: "3rd Generation Partnership Project; Technical Specification Group Services and System Aspects (SA); Service accessibility (3G TS 22.011 Release 1999)".	Y
3GPP TS 22.016: "3rd Generation Partnership Project; Technical Specification Group Services and System Aspects; International Mobile Equipment Identities (IMEI) (Release 1999)".	Y
3GPP TS 22.022: "3rd Generation Partnership Project; Universal Mobile Telecommunications System (UMTS); Personalisation of GSM Mobile Equipment (ME); Mobile functionality specification (Release 1999)".	Y

Title	Applicability
3GPP TS 22.030: "3rd Generation Partnership Project; Technical Specification Group Services and System Aspects; Man-Machine Interface (MMI) of the User Equipment (UE) (Release 1999)".	See 4.20
3GPP TS 22.038: "3rd Generation Partnership Project; Technical Specification Group Services and System Aspects; USIM/SIM Application Toolkit (USAT/SAT); Service description; Stage 1 (3GPP TS 22.038 Release 1999)".	See 4.21
3GPP TS 22.043: "3rd Generation Partnership Project; Universal Mobile Telecommunications System (UMTS); Support of Localised Service Area (SoLSA) Service description; Stage 1 (3G TS 22.043)".	Y
3GPP TS 22.057: "3rd Generation Partnership Project; Universal Mobile Telecommunications System (UMTS); Mobile Station Application Execution Environment (MExE); Service description; Stage 1 (3G TS 22.057 Release 1999)".	Y
3GPP TS 22.060: "3rd Generation Partnership Project; Technical Specification Group Services and System Aspects (SA); General Packet Radio Service (GPRS); Service description; Stage 1 (Release 1999)".	Y
3GPP TS 22.071: "3rd Generation Partnership Project; Technical Specification Group Systems Aspects; Location Services (LCS); Stage 1 (Release 1999)".	Y
3GPP TS 22.078: "3rd Generation Partnership Project; Technical Specification Group Services and System Aspects; Customised Applications for Mobile network Enhanced Logic (CAMEL); Service definition; Stage 1 (Release 1999)".	Y
3GPP TS 23.002: "3rd Generation Partnership Project; Technical Specification Group Services and System Aspects; Network architecture (Release 1999)".	See 4.22
3GPP TS 23.003: "3rd Generation Partnership Project; Technical Specification Group Core Network Numbering, addressing and identification (Release 1999)".	Y
3GPP TS 23.007: "3rd Generation Partnership Project; Universal Mobile Telecommunications System (UMTS); Restoration procedures (3G TS 23.007 Release 1999)".	Y
3GPP TS 23.008: "3rd Generation Partnership Project; Technical Specification Group Core Network; Organization of subscriber data (Release 1999)".	Y
3GPP TS 23.012: "3rd Generation Partnership Project; Universal Mobile Telecommunications System (UMTS); Location Management Procedures (3G TS 23.012)".	Y
3GPP TS 23.016: "3rd Generation Partnership Project; Technical Specification Group Core Network; Subscriber data management; Stage 2 (Release 1999)".	See 4.23
3GPP TS 23.032: "3rd Generation Partnership Project; Universal Mobile Telecommunications System (UMTS); Universal Geographical Area Description (GAD) (3G TS 23.032 Release 1999)".	Y
3GPP TS 23.038: "3rd Generation Partnership Project; Universal Mobile Telecommunications System (UMTS); Short Message Service (SMS) Cell Broadcast Service (CBS); Alphabets and language-specific information (3G TS 23.038 Release 1999)".	Y
3GPP TS 23.039: "3rd Generation Partnership Project; Universal Mobile Telecommunications System (UMTS); Interface protocols for the connection of Short Message Service Centres (SMSCs) to Short Message Entities (SMEs) (3G TR 23.039 Release 1999)".	Y
3GPP TS 23.040: "3rd Generation Partnership Project; Technical realization of the Short Message Service (SMS) (3G TS 23.040 Release 1999)".	Y
3GPP TS 23.041: "3rd Generation Partnership Project; Technical Specification Group Terminals; Technical realization of Cell Broadcast Service (CBS) (Release 1999)".	Y
3GPP TS 23.042: "3rd Generation Partnership Project; Technical Specification Group Terminals; Compression algorithm for text messaging services (Release 1999)".	Y
3GPP TS 23.057: "3rd Generation Partnership Project; Universal Mobile Telecommunications System (UMTS); Mobile Station Application Execution Environment (MExE); Functional description; Stage 2 (Release 1999)".	Y
3GPP TS 23.060: "3rd Generation Partnership Project; Universal Mobile Telecommunications System (UMTS); General Packet Radio Service (GPRS); Service description; Stage 2 (3G TS 23.060 Release 1999)".	Y
3GPP TS 23.073: "3rd Generation Partnership Project; Technical Specification Group Core Network; Support of Localised Service Area (SoLSA); Stage 2 (3G TS 23.073 Release 1999)".	Y
3GPP TS 23.078: "3rd Generation Partnership Project; Technical Specification Group Core Network; Customised Applications for Mobile network Enhanced Logic (CAMEL) - stage 2; (Release 1999)".	Y
3GPP TS 24.007: "3rd Generation Partnership Project; Technical Specification Group Core Network; Mobile radio interface signalling layer 3; General aspects (Release 1999)".	See 4.24
3GPP TS 24.008: "3rd Generation Partnership Project; Technical Specification Group Core Network; Mobile radio interface layer 3 specification; Core Network Protocols - Stage 3 (Release 1999)".	See 4.25
3GPP TS 24.011: "3rd Generation Partnership Project; Technical Specification Group Core Network; Point-to-Point (PP) Short Message Service (SMS) support on mobile radio interface (Release 1999)".	See 4.26

Title	Applicability
3GPP TS 24.012: "3rd Generation Partnership Project; Technical Specification Group Core Network; Short Message Service Cell Broadcast (SMSCB) Support on the Mobile Radio Interface (3G TS 24.012)".	Y
3GPP TS 24.030: "3rd Generation Partnership Project; Technical Specification Group Core Network; Location Services LCS Stage 3 SS (MO-LR) (3G TS 24.030 Release 1999)".	Y
3GPP TS 27.005: "3rd Generation Partnership Project; Technical Specification Group Terminals; Use of Data Terminal Equipment - Data Circuit terminating Equipment (DTE - DCE) interface for Short Message Service (SMS) and Cell Broadcast Service (CBS) (3G TS 27.005)".	Y
3GPP TS 27.007: "3rd Generation Partnership Project; Technical Specification Group Terminals; AT command set for User Equipment (UE) (Release 1999)".	See 4.27
3GPP TS 27.010: "3rd Generation Partnership Project; Technical Specification Group Terminals; Terminal Equipment to User Equipment (TE-UE) multiplexer protocol User Equipment (UE) (3G TS 27.010 Release 1999)".	Y
3GPP TS 27.060: "3rd Generation Partnership Project; Technical Specification Group Core Network; GPRS Mobile Stations supporting GPRS (3G TS 27.060 Release 1999)".	Y
3GPP TS 29.002: "3rd Generation Partnership Project; Technical Specification Group Core Network; Mobile Application Part (MAP) specification (Release 1999)".	See 4.28
3GPP TS 29.006: "Digital cellular telecommunications system (Phase 2+) (GSM); Universal Mobile Telecommunications System (UMTS); Interworking between the Public Land Mobile Network (PLMN) and a Packet Switched Public Data Network/Integrated Services Digital Network (PSPDN/ISDN) for the support of packet switched data transmission services (3G TS 29.006 Release 1999)".	Y
3GPP TS 29.010: "3rd Generation Partnership Project; Technical Specification Group Core Network; Information element mapping between Mobile Station - Base Station System (MS - BSS) and Base Station System - Mobile-services Switching Centre (BSS - MSC); Signalling procedures and the Mobile Application Part (MAP) (Release 1999)".	See 4.29
3GPP TS 29.016: "3rd Generation Partnership Project; Technical Specification Group Core Network; GPRS, Serving GPRS Support Node (SGSN); Visitors Location Register (VLR); Gs Interface Network Service Specification (3G TS 29.016 Release 1999)".	Y
3GPP TS 29.018: "3rd Generation Partnership Project; Technical Specification Group Core Network; GPRS, Serving GPRS Support Node (SGSN); Visitors Location Register (VLR); Gs Interface Layer 3 Specification (Release 1999)".	Y
3GPP TS 29.060: "3rd Generation Partnership Project; Technical Specification Group Core Network; GPRS Tunnelling Protocol (GTP) across the Gn and Gp Interface (Release 1999)".	Y
3GPP TS 29.061: "3rd Generation Partnership Project; Technical Specification Group Core Network; Inter-working between the Public Land Mobile Network (PLMN) supporting GPRS and Packet Data Networks (PDN) (Release 1999)".	Y
3GPP TS 29.078: "3rd Generation Partnership Project; Technical Specification Group Core Network; Customized Applications for Mobile network Enhanced Logic (CAMEL) Phase 3 CAMEL Application Part (CAP) specification (Release 1999)".	See 4.30
3GPP TS 32.015: "3rd Generation Partnership Project; Technical Specification Group Services and System Aspects; 3G call and event data for the Packet Switched (PS) domain (Release 1999)".	Y

## 4.2 Applicability of GSM 03.22

GSM 03.22 is applicable, except as described in table 2.

**Table 2: Applicability of clauses from GSM 03.22 to TAPS**

Clause	Name	Status
5	Group receive mode	N/A
5.1	General description	N/A
5.2	Requirements and technical solutions	N/A
5.2.1	Network provisions	N/A
5.2.2	Group receive mode cell monitoring	N/A
5.2.3	Group receive mode cell change	N/A
5.2.4	Uplink access in group calls	N/A

## 4.3 Applicability of GSM 03.33

GSM 03.33 is applicable, except as described in table 3.

**Table 3: Applicability of clauses from GSM 03.33 to TAPS**

Clause	Name	Status
4	Functional architecture	N/A
5	Activation, deactivation and interrogation	N/A
5.1	Activation	N/A
5.1.1	X1_1-interface	N/A
5.1.2	X1_2-interface (IRI)	N/A
5.1.3	X1_3-interface (IP)	N/A
5.2	Deactivation	N/A
5.2.1	X1_1-interface	N/A
5.2.2	X1_2-interface (IRI)	N/A
5.2.3	X1_3-interface (IP)	N/A
5.3	Interrogation	N/A
5.3.1	Interrogation of the MSC/VLR and the GMSC	N/A
5.3.2	Interrogation of Delivery Functions	N/A
6	Invocation of Lawful Interception	N/A
6.1	Provision of Intercept Product - Circuit Switched	N/A
6.1.1	Void	N/A
6.1.2	Two stubline configuration (circuit switched data or speech) to LEA	N/A
6.1.3	X3-interface	N/A
6.2	Provision of Intercept Product - Short Message Service	N/A
6.3	Provision of Intercept Related Information	N/A
6.3.1	X2-interface	N/A
6.3.2	Structure of the events	N/A
6.3.3	Call Related events	N/A
6.3.3.1	Call establishment	N/A
6.3.3.2	Answer	N/A
6.3.3.3	Supplementary Services	N/A
6.3.3.4	Handover	N/A
6.3.3.5	Release	N/A
6.3.4	Non Call Related events	N/A
6.3.4.1	SMS	N/A
6.3.4.2	Location update	N/A
6.3.4.3	Subscriber Controlled Input (SCI)	N/A
6.4	Intercept cases for supplementary services	N/A
6.4.1	Interception of Multiparty call	N/A
6.4.1.1	Intercept Product only for Multiparty	N/A
6.4.1.2	Intercept Related Information for Multiparty	N/A
6.4.2	Interception for Call Forwarding/Call Deflection	N/A
6.4.3	Interception on Call Hold/Call Waiting	N/A
6.4.4	Interception after ECT	N/A
7	Security	N/A
7.1	Security	N/A
7.1.1	Administration security	N/A
7.1.2	IRI security	N/A
7.1.2.1	Normal operation	N/A
7.1.2.2	Communication failure	N/A
7.1.3	IP security	N/A
7.1.4	Security aspects of Lawful Interception charging	N/A
7.1.5	Other security issues	N/A
7.1.5.1	Log files	N/A
7.1.5.2	Data consistency	N/A
Annex A	Information flows for Lawful Interception invocation	N/A
A.1	Mobile originated circuit switched calls	N/A
A.2	Mobile terminated circuit switched calls	N/A
A.3	Call hold/call waiting	N/A
A.4	Multiparty calls	N/A
A.5	Call forwarding/call deflection	N/A
A.5.1	Unconditional call forwarding	N/A
A.5.2	Call forwarding on not reachable (IMSI detached)	N/A



Clause	Name	Status
A.5.3	Call forwarding on busy (network determined)	N/A
A.5.4	Call forwarding on not reachable (no response to paging/radio channel failure)	N/A
A.5.5	Call forwarding on no reply	N/A
A.5.6	Call forwarding on busy (user determined)/call deflection	N/A
A.5.7	Call waiting/call forwarding on no reply	N/A
A.6	Explicit call transfer	N/A

## 4.4 Applicability of GSM 04.13

GSM 04.13 is applicable, except as described in table 4.

**Table 4: Applicability of clauses from GSM 04.13 to TAPS**

Clause	Name	Status
5.4	Layer 3 Call Control signalling	N/A
5.4.1	Time to send SETUP message	N/A
5.4.2	Response times to CC messages	N/A
5.4.3	User alerting	N/A
5.4.4	Call establishment	N/A
5.4.5	Call reestablishment	N/A
5.4.6	In call modification	N/A
5.4.7	DTMF	N/A
5.5	Supplementary service signalling	N/A
5.5.1	Advice of Charge Charging (AoCC)	N/A

## 4.5 Applicability of GSM 04.14

GSM 04.14 is applicable, except as described in table 5.

**Table 5: Applicability of clauses from GSM 04.14 to TAPS**

Clause	Name	Status
5.1	Single-slot TCH loops	N/A
5.1.1	Purpose of Single-slot TCH loops	N/A
5.1.2	TCH loop including signalling of erased frames (A)	N/A
5.1.2.1	Procedure	N/A
5.1.3	Speech TCH loop without signalling of erased frames (B)	N/A
5.1.3.1	Procedure	N/A
5.1.4	TCH burst-by-burst loop (C)	N/A
5.1.4.1	Applicability	N/A
5.1.4.2	Procedure	N/A
5.1.4.3	Establishment	N/A
5.1.4.4	Operation	N/A
5.1.5	TCH loop including signalling of erased frames and unreliable frames (D)	N/A
5.1.5.1	Procedure	N/A
5.1.6	TCH loop including signalling of erased SID frames (E)	N/A
5.1.6.1	Procedure	N/A
5.1.7	TCH loop including signalling of erased valid SID frames (F)	N/A
5.1.7.1	Procedure	N/A
5.1.8	Additional non-mandatory operating characteristics for single-slot loops	N/A
5.2	Multi-slot TCH loops	N/A
5.2.1	Purpose of Multi-slot TCH loops	N/A
5.2.2	Multi-slot TCH burst-by-burst loop (G)	N/A
5.2.2.1	Procedure	N/A
5.2.3	Multi-slot TCH loop including signalling of erased frames (H)	N/A
5.2.3.1	Procedure	N/A
5.3	Deactivating loops	N/A
5.3.1	Deactivating Single-slot TCH loops	N/A
5.3.2	Deactivating Multi-slot TCH loops	N/A

Clause	Name	Status
7	Activating and deactivating DAI tests	N/A
8.1	CLOSE_TCH_LOOP_CMD	N/A
8.2	CLOSE_TCH_LOOP_ACK	N/A
8.3	OPEN_LOOP_CMD	N/A
8.4	CLOSE_Multi-slot_LOOP_CMD	N/A
8.5	CLOSE_Multi-slot_LOOP_ACK	N/A
8.6	OPEN_Multi-slot_LOOP_CMD	N/A
8.7	OPEN_Multi-slot_LOOP_ACK	N/A
10	Digital audio interface	N/A
10.1	General	N/A
10.2	Formal aspects	N/A
10.3	Hardware aspect of the interface	N/A
10.3.1	Mechanical characteristics of the interface	N/A
10.3.2	Electrical characteristics of the interface	N/A
10.3.3	Timing characteristics of the interface	N/A
10.4	Logical interface	N/A
10.5	Functionality of the DAI	N/A

## 4.6 Applicability of GSM 04.18

GSM 04.18 is applicable, except as described in table 6 and annex A.

**Table 6: Applicability of clauses from GSM 04.18 to TAPS**

Clause	Name	Status
1.4	Test procedures	N/A
1.5	Use of logical channels	See annex A
1.6.1	List of procedures	See annex A
1.7.1	Voice Group Call Service (VGCS) and Voice Broadcast Service (VBS)	N/A
1.7.2	General Packet Radio Service (GPRS)	See annex A
2.1.2	Vocabulary	See annex A
3.1	Overview/General	See annex A
3.1.1	General	See annex A
3.1.2.1	Idle mode	See annex A
3.1.2.2	Dedicated mode	See annex A
3.1.2.3	Group receive mode	N/A
3.1.2.4	Group transmit mode	N/A
3.1.2.6	Packet transfer mode	See annex A
3.1.2.7	Dual transfer mode (DTM)	N/A
3.1.4.3	Sequenced message transfer operation	See annex A
3.1.4.3.1.1	Send state variable V(SD)	See annex A
3.1.4.3.2.3	Termination	See annex A
3.1.6	Preemption	See annex A
3.2.1	Mobile Station side	See annex A
3.2.2.1	System information broadcasting	See annex A
3.3.1.1.1	Permission to access the network	See annex A
3.3.1.1.3.2	Assignment rejection	See annex A
3.3.1.1.4.1	Early classmark sending	See annex A
3.3.1.2	Entering the group transmit mode: uplink access procedure	N/A
3.3.1.2.1	Mobile station side	N/A
3.3.1.2.1.1	Uplink investigation procedure	N/A
3.3.1.2.1.2	Uplink access procedure	N/A
3.3.1.2.2	Network side	N/A
3.3.1.2.3	Abnormal cases	N/A
3.3.2.1	Paging initiation by the network	See annex A
3.3.2.1.1	Paging initiation using paging subchannel on CCCH	See annex A
3.3.3	Notification procedure	N/A
3.3.3.1	Notification of a call	N/A
3.3.3.2	Joining a VGCS or VBS call	N/A
3.3.3.3	Reduced NCH monitoring mechanism	N/A
3.3.3.4	Notification response procedure	N/A
3.4	Procedures in dedicated mode and in group transmit mode	See annex A

Clause	Name	Status
3.4.1.1	General	See annex A
3.4.1.2	Measurement report and Enhanced Measurement Report	See annex A
3.4.1.2.1	Parameters for Measurements and Reporting	See annex A
3.4.1.2.1.1	Deriving the 3G Neighbour Cell list from the 3G Neighbour Cell Description:	N/A
3.4.1.2.1.2	Deriving the GSM Neighbour Cell list from the BSICs and the BA (list)	See annex A
3.4.1.2.1.3	Deriving the Neighbour Cell list from the GSM Neighbour Cell list and the 3G Neighbour Cell list	N/A
3.4.1.2.1.4	Real Time Differences	See annex A
3.4.1.2.1.6	GPRS Parameters	N/A
3.4.1.2.1.7	The 3G Cell Reselection list	N/A
3.4.1.3	Extended measurement report \$(MAFA)\$	See annex A
3.4.2	Transfer of messages and link layer service provision	See annex A
3.4.3	Channel assignment procedure	See annex A
3.4.3.1	Channel assignment initiation	See annex A
3.4.3.3	Abnormal cases	See annex A
3.4.4	Handover procedure	See annex A
3.4.4.1	Handover initiation	See annex A
3.4.4.3	Handover completion	See annex A
3.4.4.4	Abnormal cases	See annex A
3.4.4a	Handover to UMTS procedure	N/A
3.4.4a.1	Handover to UMTS initiation	N/A
3.4.4a.2	Handover to UMTS completion	N/A
3.4.4a.3	Abnormal cases	N/A
3.4.5	Frequency redefinition procedure	See annex A
3.4.6	Channel mode modify procedure	N/A
3.4.6.1	Normal channel mode modify procedure	N/A
3.4.6.1.1	Initiation of the channel mode modify procedure	N/A
3.4.6.1.2	Completion of channel mode modify procedure	N/A
3.4.6.1.3	Abnormal cases	N/A
3.4.6.2	Channel mode modify procedure for a voice group call talker	N/A
3.4.6.2.1	Initiation of the channel mode modify procedure	N/A
3.4.6.2.2	Completion of mode change procedure	N/A
3.4.6.2.3	Abnormal cases	N/A
3.4.7	Ciphering mode setting procedure	See annex A
3.4.8	Additional channel assignment procedure	N/A
3.4.8.1	Additional assignment procedure initiation	N/A
3.4.8.2	Additional assignment procedure completion	N/A
3.4.8.3	Abnormal cases	N/A
3.4.9	Partial channel release procedure	N/A
3.4.9.1	Partial release procedure initiation	N/A
3.4.9.2	Abnormal cases	N/A
3.4.10	Classmark change procedure	See annex A
3.4.11	Classmark interrogation procedure	See annex A
3.4.11.2	Classmark interrogation completion	See annex A
3.4.12	Indication of notifications and paging information	N/A
3.4.13.1	Normal release procedure	See annex A
3.4.13.1.1	Channel release procedure initiation in dedicated mode and in group transmit mode	See annex A
3.4.13.2	Radio link failure in dedicated mode or dual transfer mode	See annex A
3.4.13.2.1	Mobile side	See annex A
3.4.13.2.2	Network side	See annex A
3.4.13.3	RR connection abortion in dedicated mode or dual transfer mode	See annex A
3.4.13.4	Uplink release procedure in group transmit mode	N/A
3.4.13.5	Radio link failure in group transmit mode	N/A
3.4.13.5.1	Mobile side	N/A
3.4.13.5.2	Network side	N/A
3.4.15	Group receive mode procedures	N/A
3.4.15.1	Mobile station side	N/A
3.4.15.1.1	Reception of the VGCS or VBS channel	N/A
3.4.15.1.2	Monitoring of downlink messages and related procedures	N/A
3.4.15.1.2.1	(void)	N/A
3.4.15.1.2.2	(void)	N/A
3.4.15.1.2.3	Channel mode modify procedure	N/A
3.4.15.1.2.4	Notification and paging information	N/A

Clause	Name	Status
3.4.15.1.2.4.1	Use of Reduced NCH monitoring	N/A
3.4.15.1.2.5	Uplink status messages	N/A
3.4.15.1.2.6	Channel release message	N/A
3.4.15.1.2.7	Information on paging channel restructuring	N/A
3.4.15.1.3	Uplink reply procedure	N/A
3.4.15.1.4	Leaving the group receive mode	N/A
3.4.15.1.4.1	Returning to idle mode	N/A
3.4.15.1.4.2	Going to group transmit mode	N/A
3.4.15.2	Network side	N/A
3.4.15.2.1	Provision of messages on the VGCS or VBS channel downlink	N/A
3.4.15.2.1.1	General	N/A
3.4.15.2.1.2	Provision of general information messages	N/A
3.4.15.2.1.3	Provision of messages related to the voice group call uplink channel	N/A
3.4.15.2.2	Release of the VGCS or VBS Channels	N/A
3.4.15.3	Failure cases	N/A
3.4.16	Configuration change procedure	N/A
3.4.16.1	Configuration change initiation	N/A
3.4.16.2	Configuration change completion	N/A
3.4.16.3	Abnormal cases	N/A
3.4.17	Mapping of user data substreams onto timeslots in a multislot configuration	N/A
3.4.19	Assignment to a Packet Data channel	See annex A
3.4.19.3	Abnormal cases	See annex A
3.4.20	RR-Network Commanded Cell Change Order	See annex A
3.4.20.1	RR-network commanded cell change order initiation	See annex A
3.4.20.3	Abnormal cases	See annex A
3.4.22	RR procedures related to packet resource establishment while in dedicated mode	N/A
3.4.22.1	Packet request procedure while in dedicated mode	N/A
3.4.22.1.1	Entering the dual transfer mode	N/A
3.4.22.1.1.1	Permission to access the network	N/A
3.4.22.1.1.2	Initiation of establishment of the packet request procedure	N/A
3.4.22.1.1.3	Answer from the network	N/A
3.4.22.1.1.3.1	Packet assignment	N/A
3.4.22.1.1.3.2	RR reallocation only	N/A
3.4.22.1.1.3.3	Packet request rejection	N/A
3.4.22.1.1.4	Packet request completion	N/A
3.4.22.1.1.5	Abnormal cases	N/A
3.4.22.2	Packet notification procedure in dedicated mode	N/A
3.4.22.2.1	Packet notification initiation by the network	N/A
3.4.22.2.2	Packet notification response	N/A
3.4.22.3	Packet downlink assignment in dedicated mode	N/A
3.4.22.3.1	Initiation of the packet downlink assignment procedure in dedicated mode	N/A
3.4.22.3.2	Packet downlink assignment completion	N/A
3.4.22.3.3	Abnormal cases	N/A
3.4.22.4	Modification of packet resources while in DTM	N/A
3.4.23	RR procedures related to packet resource maintenance while in dual transfer mode	N/A
3.4.24	RR procedures related to packet resource release while in dual transfer mode	N/A
3.4.25	GPRS suspension procedure	N/A
3.4.25.1	General	N/A
3.4.25.2	MS in class B mode of operation	N/A
3.4.25.3	Dual transfer mode not supported	N/A
5	Elementary procedures for circuit-switched Call Control	N/A
8.5.1	Radio resource management	See annex A
9	Message functional definitions and contents	See annex A
9.1	Messages for Radio Resources management	See annex A
9.1.1	Additional assignment	N/A
9.1.1.1	Mobile Allocation	N/A
9.1.1.2	Starting Time	N/A
9.1.5	Channel mode modify	N/A
9.1.5.1	Channel Description	N/A
9.1.5.2	VGCS target mode Indication	N/A
9.1.5.3	Multi Rate configuration	N/A
9.1.6	Channel mode modify acknowledge	N/A

Clause	Name	Status
9.1.7	Channel release	See annex A
9.1.7.1	Channel description and mobile allocation	N/A
9.1.7.2	Group Cipher Key Number	N/A
9.1.7.3	UMTS Frequency List	N/A
9.1.8	Channel request	See annex A
9.1.11.2	Mobile Station Classmark	See annex A
9.1.11a	UTRAN Classmark Change	N/A
9.1.11b	cdma2000 Classmark Change	N/A
9.1.12b	Configuration change command	N/A
9.1.12b.1	Description of the multislot allocation	N/A
9.1.12b.2	Mode of Channel Set "X" ( $1 \leq X \leq 8$ )	N/A
9.1.12c	Configuration change acknowledge	N/A
9.1.12d	Configuration change reject	N/A
9.1.12e	DTM Assignment Command	N/A
9.1.12e.1	TBF starting time	N/A
9.1.12e.2	RR Packet Uplink Assignment and RR Packet Downlink Assignment IEs	N/A
9.1.12f	DTM Assignment Failure	N/A
9.1.12g	DTM Information	N/A
9.1.12h	DTM Reject	N/A
9.1.12i	DTM Request	N/A
9.1.13b	GPRS suspension request	N/A
9.1.15	Handover command	See annex A
9.1.15.11	VGCS target mode indication	N/A
9.1.15.12	Description of the multislot allocation	N/A
9.1.15.13	MultiRateconfiguration	N/A
9.1.15a	Inter System To UTRAN Handover Command	N/A
9.1.15b	Inter System To cdma2000 Handover Command	N/A
9.1.21a	Notification/FACCH	N/A
9.1.21a.1	(void)	N/A
9.1.21a.2	(void)	N/A
9.1.21a.3	(void)	N/A
9.1.21a.4	(void)	N/A
9.1.21b	Notification/NCH	N/A
9.1.21b.1	(void)	N/A
9.1.21b.2	(void)	N/A
9.1.21d	Notification response	N/A
9.1.21e	RR-Cell Change Order	See annex A
9.1.21e.1	3G Target Cell	N/A
9.1.26	Partial release	N/A
9.1.26.1	Channel Description	N/A
9.1.27	Partial release complete	N/A
9.1.34a	System information type 2quater	N/A
9.1.43g	System information type 18	N/A
9.1.43h	System information type 20	N/A
9.1.44	Talker indication	N/A
9.1.45	Uplink access	N/A
9.1.46	Uplink busy	N/A
9.1.47	Uplink free	N/A
9.1.48	Uplink release	N/A
9.1.49	VGCS uplink grant	N/A
9.1.50	System information type 10 \$(ASCII)\$	N/A
9.3	Messages for circuit-switched call control	N/A
10.1	Overview	See annex A
10.4	Message Type	See annex A
10.5	Other information elements	See annex A
10.5.2.1d	UMTS Frequency List	N/A
10.5.2.6	Channel Mode	See annex A
10.5.2.7	Channel Mode 2	See annex A
10.5.2.7a	UTRAN pre-defined configuration status information/START-CS/UE Capability information element	N/A
10.5.2.8b	Channel Request Description 2	N/A
10.5.2.11a	DTM Information Rest Octets	N/A
10.5.2.14b	Group Channel Description	N/A
10.5.2.14c	GPRS Resumption	N/A

Clause	Name	Status
10.5.2.21aa	MultiRate configuration	N/A
10.5.2.21b	Multislot Allocation	N/A
10.5.2.33b	SI 2quarter Rest Octets	N/A
10.5.2.37h	SI 18 Rest Octets	N/A
10.5.2.37i	SI 20 Rest Octets	N/A
10.5.2.40	Timing Advance	See annex A
10.5.2.42a	VGCS target mode Indication	N/A
10.5.2.44	SI10 rest octets \$(ASCI)\$	N/A
10.5.2.47	Suspension Cause	See annex A
10.5.2.51	Handover To UTRAN Command	N/A
10.5.2.52	Handover To cdma2000 Command	N/A
10.5.2.56	3G Target Cell	N/A
10.5.4	Call control information elements.	N/A
11.1.1	Timers on the mobile station side	See annex A
11.1.2	Timers on the network side	See annex A
11.1.3	Other parameters	See annex A
11.3	Timers of circuit-switched call control	N/A
Annex E	Comparison between call control procedures specified in 3GPP TS 24.008 and ITU-T Recommendation Q.931	N/A
Annex F	GSM specific cause values for radio resource management	See annex A
Annex H	GSM specific cause values for call control	N/A

## 4.7 Applicability of GSM 04.60

GSM 04.60 is applicable, except as described in table 7 and annex B.

**Table 7: Applicability of clauses from GSM 04.60 to TAPS**

Clause	Name	Status
3.1	Vocabulary	See annex B
5.2.4	Medium Access modes	See annex B
5.4a	Dual transfer mode	N/A
5.5	General procedures in packet idle and packet transfer modes	See annex B
5.5.1.1b.1	General	See annex B
5.5.1.1b.4	Receipt of PSI14 message in dual transfer mode	N/A
5.5.1.5	Discontinuous reception (DRX)	See annex B
5.5.1.6	Page mode procedures on PCCCH	See annex B
5.5.1.7	Frequency Parameters	See annex B
5.5.2.1.3	System information on PACCH (and other logical channels)	See annex B
5.6.1	Network Control (NC) measurement reporting	See annex B
5.6.3.1	Deriving the 3G Neighbour Cell list from the 3G Neighbour Cell description	N/A
5.6.3.3	Deriving the Neighbour Cell list from the GSM Neighbour Cell list and the 3G Neighbour Cell list	See annex B
5.6.3.5	GPRS Report Priority Descriptions	See annex B
5.6.3.6	GPRS Measurement Parameters and GPRS 3G Measurement Parameters	See annex B
6.1	Paging procedure for RR connection establishment	See annex B
6.1.3	Paging initiation using PACCH	See annex B
6.1.4	Paging response	See annex B
6.2	Paging procedure for downlink packet transfer	See annex B
7.1	TBF establishment initiated by the mobile station on PCCCH	See annex B
7.1.2.1	Initiation of the packet access procedure	See annex B
7.1.2.2.4	Packet access reject procedure	See annex B
7.2	TBF establishment initiated by the network on PCCCH	See annex B
7.4.1	Cell Change Order procedure initiated on PCCCH	See annex B
7.4.2	Cell Change Order procedure initiated on CCCH	See annex B
8.0	General	See annex B
8.1.0	Medium access mode	See annex B
8.1.1.1	Dynamic allocation uplink RLC data block transfer	See annex B
8.1.1.1.2	Resource Reallocation for Uplink	See annex B
8.1.1.1.2.1	Abnormal cases	See annex B
8.1.1.1.3.1	Abnormal cases	See annex B
8.1.1.3.2	Reallocation for open-ended TBF	See annex B

Clause	Name	Status
8.1.1.3.2.5	Abnormal Cases	See annex B
8.1.1.3a	Exclusive allocation RLC data block transfer	N/A
8.1.1.3a.1	General	N/A
8.1.1.3a.2	Radio link failure	N/A
8.1.1.3a.3	Open-ended and close-ended TBF	N/A
8.1.1.3a.4	PACCH operation	N/A
8.1.1.3a.5	Resource Reallocation for Uplink	N/A
8.1.1.3a.5.1	General	N/A
8.1.1.3a.5.2	Change of service demand	N/A
8.1.1.3a.5.3	Reallocation of radio resources for an uplink TBF	N/A
8.1.1.3a.5.4	Rejection of new service demand	N/A
8.1.1.3a.5.5	Abnormal cases	N/A
8.1.1.3a.6	Establishment of Downlink TBF	N/A
8.1.1.3a.6.1	General	N/A
8.1.1.3a.6.2	Abnormal cases	N/A
8.1.1.5	Abnormal cases	See annex B
8.1.2.1	Downlink RLC data block transfer	See annex B
8.1.2.1.1	Abnormal cases	See annex B
8.1.2.4.1	Abnormal cases	See annex B
8.1.2.5.1	Abnormal cases	See annex B
8.1.2.8	Network initiated abnormal release of downlink TBF	See annex B
8.4	Network controlled cell reselection procedure	See annex B
8.4.2	Abnormal cases	See annex B
8.7.1	Abnormal release without retry	See annex B
8.7.2	Abnormal release with access retry	See annex B
9.3.2.4	Release of uplink Temporary Block Flow	See annex B
9.3.2.6	Release of downlink Temporary Block Flow	See annex B
9.3.3.3	Release of uplink Temporary Block Flow	See annex B
9.3.3.5	Release of downlink Temporary Block Flow	See annex B
9.4.2	Abnormal release with cell reselection	See annex B
10.4.5.1	Special requirements in dual transfer mode	N/A
10.4.10a	Power Reduction (PR) field	See annex B
11.2	RLC/MAC control messages	See annex B
11.2.7.1	Special requirements in dual transfer mode for downlink TBF	N/A
11.2.29.1	Special requirements in dual transfer mode for uplink TBF	N/A
12.1	Overview	See annex B

## 4.8 Applicability of GSM 05.01

GSM 05.01 is applicable, except as described in table 8 and annex C.

**Table 8: Applicability of clauses from GSM 05.01 to TAPS**

Clause	Name	Status
2	Set of channels	See annex C
3	Reference configuration	See annex C
4	The block structures	See annex C
5.1	Hyperframes, superframes and multiframes	See annex C
5.2	Time slots and bursts	See annex C
5.3	Channel organization	See annex C
6	Frequency hopping capability	See annex C
7.1	General	See annex C
9	Transmission and reception	See annex C
10	Other layer 1 functions	See annex C
11	Performance	See annex C

## 4.9 Applicability of GSM 05.02

GSM 05.02 is applicable, except as described in table 9 and annex D.

**Table 9: Applicability of clauses from GSM 05.02 to TAPS**

Clause	Name	Status
3.2.1	General	See annex D
3.2.2	Speech traffic channels	N/A
3.2.3	Circuit switched data traffic channels	N/A
3.3.1	General	See annex D
3.3.2.4.1	Packet Broadcast Control Channel (PBCCH)	See annex D
3.3.3.1	Common control type channels, known when combined as a common control channel (CCCH)	See annex D
3.3.3.2.1	Packet Common Control Channels (PCCCH)	See annex D
3.3.4.1	Circuit switched dedicated control channels	See annex D
3.3.6	CTS control channels	N/A
3.3.6.1	CTS beacon channel (BCH)	N/A
3.3.6.2	CTS paging channel (CTSPCH)	N/A
3.3.6.3	CTS access request channel (CTSARCH)	N/A
3.3.6.4	CTS access grant channel (CTSAGCH)	N/A
5.2.3	Normal burst (NB)	See annex D
5.2.5	Synchronization Burst (SB)	See annex D
6.2.1	General	See annex D
6.2.2	Parameters	See annex D
6.2.3	Hopping sequence generation	See annex D
6.2.6	Frequency assignment in CTS	N/A
6.3.1.2	Key to the mapping table of clause 7	See annex D
6.3.1.3	Mapping of BCCH data	See annex D
6.3.1.4	Mapping of SID Frames	N/A
6.3.2.2.1	Mapping of uplink packet traffic channel (PDTCH/U) and PACCH/U	See annex D
6.3.2.2.2	Mapping of the Packet Timing Advance Control Channel (PTCCH/U)	See annex D
6.4.1	Permitted channel combinations onto a basic physical channel	See annex D
6.4.2	Multislot configurations	See annex D
6.4.2.1	Multislot configurations for circuit switched connections	N/A
6.4.2.3	Multislot configurations for dual transfer mode	N/A
6.5.1	General	See annex D
6.5.5	Voice group and voice broadcast call notifications	N/A
6.5.7	Determination of CTS_PAGING_GROUP and specific paging 52-multiframe for MS in CTS mode	N/A
7	Tables	See annex D
Annex A	Phase 2 mobiles in a Phase 1 infrastructure	N/A
A.1	Scope	N/A
A.2	Implementation options for TCH channels	N/A
A.2.1	C0 filling on the TCH	N/A
A.2.1.1	A dummy burst with (BN61, BN62, BN86) = training sequence bits of normal bursts	N/A
A.2.1.2	A dummy burst with the "C0 filling training sequence	N/A
A.2.1.3	A dummy burst with (BN61, BN62, BN86) mapped from the TSC bits of normal bursts according to the table	N/A
A.2.1.4	Partial SID information	N/A
A.2.2	Half burst filling	N/A
A.2.2.1	Partial SID information from any associated SID frame; or	N/A
A.2.2.2	The mixed bits of the dummy bursts (encrypted or not encrypted)	N/A
A.2.3	Dummy burst Stealing flag	N/A
A.2.4	Half burst Filling Stealing flag	N/A
A.2.5	Allowed combinations	N/A
A.3	Idle Channels	N/A
B.1	MS classes for multislot capability	See annex D
B.2	Constraints imposed by the service selected	See annex D
B.3	Network requirements for supporting MS multislot classes	See annex D
Annex C	CTSBCH Timeslot shifting example	N/A



## 4.10 Applicability of GSM 05.03

GSM 05.03 is applicable, except as described in table 10 and annex E.

**Table 10: Applicability of clauses from GSM 05.03 to TAPS**

Clause	Name	Status
2.1	General organization	See annex E
2.2	Naming Convention	See annex E
3	Traffic Channels (TCH)	N/A
3.1	Speech channel at full rate (TCH/FS and TCH/EFS)	N/A
3.1.1	Preliminary channel coding for EFR only	N/A
3.1.1.1	CRC calculation	N/A
3.1.1.2	Repetition bits	N/A
3.1.1.3	Correspondence between input and output of preliminary channel coding	N/A
3.1.2	Channel coding for FR and EFR	N/A
3.1.2.1	Parity and tailing for a speech frame	N/A
3.1.2.2	Convolutional encoder	N/A
3.1.3	Interleaving	N/A
3.1.4	Mapping on a Burst	N/A
3.2	Speech channel at half rate (TCH/HS)	N/A
3.2.1	Parity and tailing for a speech frame	N/A
3.2.2	Convolutional encoder	N/A
3.2.3	Interleaving	N/A
3.2.4	Mapping on a burst	N/A
3.3	Data channel at full rate, 12,0 kbit/s radio interface rate (9,6 kbit/s services (TCH/F9.6))	N/A
3.3.1	Interface with user unit	N/A
3.3.2	Block code	N/A
3.3.3	Convolutional encoder	N/A
3.3.4	Interleaving	N/A
3.3.5	Mapping on a Burst	N/A
3.4	Data channel at full rate, 6,0 kbit/s radio interface rate (4,8 kbit/s services (TCH/F4.8))	N/A
3.4.1	Interface with user unit	N/A
3.4.2	Block code	N/A
3.4.3	Convolutional encoder	N/A
3.4.4	Interleaving	N/A
3.4.5	Mapping on a Burst	N/A
3.5	Data channel at half rate, 6,0 kbit/s radio interface rate (4,8 kbit/s services (TCH/H4.8))	N/A
3.5.1	Interface with user unit	N/A
3.5.2	Block code	N/A
3.5.3	Convolutional encoder	N/A
3.5.4	Interleaving	N/A
3.5.5	Mapping on a Burst	N/A
3.6	Data channel at full rate, 3,6 kbit/s radio interface rate (2,4 kbit/s and less services (TCH/F2.4))	N/A
3.6.1	Interface with user unit	N/A
3.6.2	Block code	N/A
3.6.3	Convolutional encoder	N/A
3.6.4	Interleaving	N/A
3.6.5	Mapping on a Burst	N/A
3.7	Data channel at half rate, 3,6 kbit/s radio interface rate (2,4 kbit/s and less services (TCH/H2.4))	N/A
3.7.1	Interface with user unit	N/A
3.7.2	Block code	N/A
3.7.3	Convolutional encoder	N/A
3.7.4	Interleaving	N/A
3.7.5	Mapping on a Burst	N/A
3.8	Data channel at full rate, 14,5 kbit/s radio interface rate (14,4 kbit/s services (TCH/F14.4))	N/A
3.8.1	Interface with user unit	N/A
3.8.2	Block code	N/A
3.8.3	Convolutional encoder	N/A

Clause	Name	Status
3.8.4	Interleaving	N/A
3.8.5	Mapping on a Burst	N/A
3.9	Adaptive multi rate speech channel at full rate (TCH/AFS)	N/A
3.9.1	SID_UPDATE	N/A
3.9.1.1	Coding of in-band data	N/A
3.9.1.2	Parity and convolutional encoding for the comfort noise parameters	N/A
3.9.1.3	Identification marker	N/A
3.9.1.4	Interleaving	N/A
3.9.1.5	Mapping on a Burst	N/A
3.9.2	SID_FIRST	N/A
3.9.2.1	Coding of in-band data	N/A
3.9.2.2	Identification marker	N/A
3.9.2.3	Interleaving	N/A
3.9.2.4	Mapping on a Burst	N/A
3.9.3	ONSET	N/A
3.9.3.1	Coding of in-band data	N/A
3.9.3.2	Interleaving	N/A
3.9.3.3	Mapping on a Burst	N/A
3.9.4	SPEECH	N/A
3.9.4.1	Coding of the in-band data	N/A
3.9.4.2	Ordering according to subjective importance	N/A
3.9.4.3	Parity for speech frames	N/A
3.9.4.4	Convolutional encoder	N/A
3.9.4.5	Interleaving	N/A
3.9.4.6	Mapping on a Burst	N/A
3.9.5	RATSCCH	N/A
3.9.5.1	Coding of in-band data	N/A
3.9.5.2	Parity and convolutional encoding for the RATSCCH message	N/A
3.9.5.3	Identification marker	N/A
3.9.5.4	Interleaving	N/A
3.9.5.5	Mapping on a Burst	N/A
3.10	Adaptive multi rate speech channel at half rate (TCH/AHS)	N/A
3.10.1	SID_UPDATE	N/A
3.10.1.1	Coding of in-band data	N/A
3.10.1.2	Parity and convolutional encoding for the comfort noise parameters	N/A
3.10.1.3	Identification marker	N/A
3.10.1.4	Interleaving	N/A
3.10.1.5	Mapping on a Burst	N/A
3.10.2	SID_UPDATE_INH	N/A
3.10.2.1	Coding of in-band data	N/A
3.10.2.2	Identification marker	N/A
3.10.2.3	Interleaving	N/A
3.10.2.4	Mapping on a Burst	N/A
3.10.3	SID_FIRST_P1	N/A
3.10.3.1	Coding of in-band data	N/A
3.10.3.2	Identification marker	N/A
3.10.3.3	Interleaving	N/A
3.10.3.4	Mapping on a Burst	N/A
3.10.4	SID_FIRST_P2	N/A
3.10.4.1	Coding of in-band data	N/A
3.10.4.2	Interleaving	N/A
3.10.4.3	Mapping on a Burst	N/A
3.10.5	SID_FIRST_INH	N/A
3.10.5.1	Coding of in-band data	N/A
3.10.5.2	Identification marker	N/A
3.10.5.3	Interleaving	N/A
3.10.5.4	Mapping on a Burst	N/A
3.10.6	ONSET	N/A
3.10.6.1	Coding of in-band data	N/A
3.10.6.2	Interleaving	N/A
3.10.6.3	Mapping on a Burst	N/A
3.10.7	SPEECH	N/A
3.10.7.1	Coding of the in-band data	N/A
3.10.7.2	Ordering according to subjective importance	N/A

Clause	Name	Status
3.10.7.3	Parity for speech frames	N/A
3.10.7.4	Convolutional encoder	N/A
3.10.7.5	Interleaving	N/A
3.10.7.6	Mapping on a Burst	N/A
3.10.8	RATSCCH_MARKER	N/A
3.10.8.1	Coding of in-band data	N/A
3.10.8.2	Identification marker	N/A
3.10.8.3	Interleaving	N/A
3.10.8.4	Mapping on a Burst	N/A
3.10.9	RATSCCH_DATA	N/A
3.10.9.1	Coding of in-band data	N/A
3.10.9.2	Parity and convolutional encoding for the RATSCCH message	N/A
3.10.9.3	Interleaving	N/A
3.10.9.4	Mapping on a Burst	N/A
3.11	Data channel for ECSD at full rate, 29,0 kbit/s radio interface rate (28,8 kbit/s services (E-TCH/F28,8))	N/A
3.11.1	Interface with user unit	N/A
3.11.2	Block code	N/A
3.11.2.1	Repetition bits	N/A
3.11.2.2	Reed Solomon encoder	N/A
3.11.3	Convolutional encoder	N/A
3.11.3.1	Tailing bits for a data frame	N/A
3.11.3.2	Convolutional encoding for a data frame	N/A
3.11.4	Interleaving	N/A
3.11.5	Mapping on a Burst	N/A
3.12	Data channel for ECSD at full rate, 32,0 kbit/s radio interface rate (32,0 kbit/s services (E-TCH/F32.0))	N/A
3.12.1	Interface with user unit	N/A
3.12.2	Block code	N/A
3.12.3	Convolutional encoder	N/A
3.12.3.1	Tailing bits for a data frame	N/A
3.12.3.2	Convolutional encoding for a data frame	N/A
3.12.4	Interleaving	N/A
3.12.5	Mapping on a Burst	N/A
3.13	Data channel for ECSD at full rate, 43,5 kbit/s radio interface rate (43,2 kbit/s services (E-TCH/F43.2))	N/A
3.13.1	Interface with user unit	N/A
3.13.2	Convolutional encoder	N/A
3.13.2.1	Tailing bits for a data frame	N/A
3.13.2.2	Convolutional encoding for a data frame	N/A
3.13.3	Interleaving	N/A
3.13.4	Mapping on a Burst	N/A
4.1.3	Convolutional encoder	See annex E
4.1.4	Interleaving	See annex E
4.2.4	Interleaving	See annex E
4.2.5	Mapping on a Burst	See annex E
4.3.4	Interleaving	See annex E
4.3.5	Mapping on a Burst	See annex E
4.4	Broadcast control, Paging, Access grant, Notification and Cell broadcast channels (BCCH, PCH, AGCH, NCH, CBCH), CTS Paging and Access grant channels (CTSPCH, CTSAGCH)	See annex E
4.7	Synchronization channel (SCH), Compact synchronization channel (CSCH), CTS Beacon and Access request channels (CTSBCH-SB, CTSARCH)	See annex E
4.8	Access Burst on circuit switched channels other than RACH	N/A
4.9	Access Bursts for uplink access on a channel used for VGCS	N/A
4.10	Fast associated control channel at ECSD E-TCH/F (E-FACCH/F)	N/A
4.10.1	Block constitution	N/A
4.10.2	Block code	N/A
4.10.3	Convolutional encoder	N/A
4.10.4	Interleaving	N/A
4.10.5	Mapping on a Burst	N/A
5.1.2.3	Convolutional encoder	See annex E

Clause	Name	Status
5.1.3.3	Convolutional encoder	See annex E
5.4	Access Burst on packet switched channels other than PRACH and CPRACH	See annex E
Annex A	Summary of Channel Types	See annex E
Annex B	Summary of Polynomials Used for Convolutional Codes	See annex E

## 4.11 Applicability of GSM 05.05

GSM 05.05 is applicable, except as described in table 11 and annex F.

**Table 11: Applicability of clauses from GSM 05.05 to TAPS**

Clause	Name	Status
2	Frequency bands and channel arrangement	See annex F
4.1.1	Mobile Station	See annex F
4.3.2.1	General requirements	See annex F
4.3.3.1	Mobile Station GSM 400, GSM 900 and DCS 1800	See annex F
4.5.1	Base Transceiver Station	See annex F
4.7.4	Mobile PBX (GSM 900 only)	N/A
5	Receiver characteristics	See annex F
5.1	Blocking characteristics	See annex F
6.1.1	GMSK modulation	See annex F
6.2	Reference sensitivity level	See annex F
6.3	Reference interference level	See annex F
6.4	Erroneous frame indication performance	See annex F
6.6	Frequency hopping performance under interference conditions	N/A
Table 1	Reference sensitivity performance	See annex F
Table 1d	Input signal level (for normal BTS) at reference performance for ECSD (GMSK and 8-PSK modulated signals)	N/A
Table 1e	Input signal level (for MS) at reference performance for ECSD (GMSK and 8-PSK modulated signals)	N/A
Table 2	Reference interference performance	See annex F
Table 2d	Cochannel interference ratio (for normal BTS) at reference performance for ECSD (GMSK and 8-PSK modulated signals)	N/A
Table 2e	Cochannel interference ratio (for MS) at reference performance for ECSD (GMSK and 8-PSK modulated signals)	N/A
Table 2h	Adjacent channel interference (for normal BTS) ratio at reference performance for ECSD (8-PSK modulated signals)	N/A
Table 2i	Adjacent channel interference (for MS) ratio at reference performance for ECSD (8-PSK modulated signals)	N/A
Annex F	Antenna Feeder Loss Compensator Characteristics (GSM 400, GSM 900 and DCS 1800)	N/A
F.1	Introduction	N/A
F.2	Transmitting path	N/A
F.2.1	Maximum output power	N/A
F.2.2	Gain	N/A
F.2.3	Burst transmission characteristics	N/A
F.2.4	Phase error	N/A
F.2.5	Frequency error	N/A
F.2.6	Group delay	N/A
F.2.7	Spurious emissions	N/A
F.2.8	VSWR	N/A
F.2.9	Stability	N/A
F.3	Receiving path	N/A
F.3.1	Gain	N/A
F.3.2	Noise figure	N/A
F.3.3	Group delay	N/A
F.3.4	Intermodulation performance	N/A
F.3.5	VSWR	N/A
F.3.6	Stability	N/A
F.4	Guidelines (informative)	N/A

## 4.12 Applicability of GSM 05.08

GSM 05.08 is applicable, except as described in table 12 and annex G.

**Table 12: Applicability of clauses from GSM 05.08 to TAPS**

Clause	Name	Status
2	General	See annex G
3.3	BSS measurement procedure	See annex G
3.4	Strategy	See annex G
4.2	MS implementation	See annex G
4.3	MS power control range	See annex G
4.4	BSS implementation	See annex G
4.7	Timing	See annex G
4.8	Dedicated channels used for a voice group call or voice broadcast	N/A
5.1	Criterion	See annex G
5.2	MS procedure	See annex G
5.3	BSS procedure	See annex G
6.6.1	Monitoring of received signal level and BCCH data	See annex G
6.7.2	Call re-establishment	See annex G
8.2.3	Statistical parameters	See annex G
8.2.4	Range of parameter RXQUAL	See annex G
8.3	Aspects of discontinuous transmission (DTX)	N/A
8.4.1	Measurement reporting for the MS on a TCH	See annex G
8.4.2	Measurement reporting for the MS on a SDCCH	See annex G
8.4.4	Common aspects for the MS on a TCH or a SDCCH	See annex G
8.4.6	Extended measurement reporting	See annex G
8.4.8.2	Measurement Reporting	See annex G
9	Control parameters	See annex G
10	GPRS mode tasks	See annex G
10.1.4.3	Exceptional cases	See annex G
10.2	RF Power Control	N/A
10.2.3.2.1	Packet transfer mode	See annex G
11	CTS mode tasks	N/A
11.1	CTS idle mode tasks	N/A
11.1.1	CTS cell selection	N/A
11.1.1.1	Synchronization and measurements for CTS cell selection	N/A
11.1.1.2	Initial synchronization of CTS-MS	N/A
11.1.2	Criterion for CTS cell selection	N/A
11.1.3	Monitoring of CTSBCH and CTSPCH	N/A
11.1.3.1	Monitoring of received signal level	N/A
11.1.3.2	Downlink beacon failure	N/A
11.1.3.3	Downlink paging failure	N/A
11.1.4	Procedures with reporting to the CTS-FP	N/A
11.1.4.1	AFA monitoring	N/A
11.1.4.2	BCCH detection	N/A
11.1.4.3	Observed Frequency Offset (OFO) measurement	N/A
11.2	Intra-cell handover	N/A
11.2.1	Overall process	N/A
11.2.2	CTS-MS measurement procedure	N/A
11.2.3	CTS-FP measurement procedure	N/A
11.2.4	Strategy	N/A
11.3	RF power control	N/A
11.3.1	Overall process	N/A
11.3.2	CTS-MS implementation	N/A
11.3.3	CTS-MS power control range	N/A
11.3.4	CTS-FP implementation	N/A
11.3.5	CTS-FP power control range	N/A
11.3.6	Strategy	N/A
11.3.7	Timing	N/A
11.4	Radio link failure	N/A
11.4.1	Criterion	N/A
11.4.2	CTS-MS procedure	N/A
11.4.3	CTS-FP procedure	N/A
11.5	Radio link measurements	N/A

Clause	Name	Status
11.5.1	Signal strength	N/A
11.5.1.1	General	N/A
11.5.1.2	Physical parameter	N/A
11.5.1.3	Statistical parameters	N/A
11.5.1.4	Range of parameter	N/A
11.5.2	Signal quality	N/A
11.5.2.1	General	N/A
11.5.2.2	Physical parameter	N/A
11.5.2.3	Statistical parameters	N/A
11.5.2.4	Range of parameter	N/A
11.5.3	Aspects of discontinuous transmission (DTX)	N/A
11.5.4	Measurement reporting for the CTS-MS on a TCH	N/A
11.6	Control of CTS-FP service range	N/A
11.7	Control parameters	N/A
A.2	Functional requirement	See annex G
B.6	Interworking between normal and fast power control for ECSD	N/A

## 4.13 Applicability of GSM 05.10

GSM 05.10 is applicable, except as described in table 13 and annex H.

**Table 13: Applicability of clauses from GSM 05.10 to TAPS**

Clause	Name	Status
2	General description of synchronization system	See annex H
3.1	Timing state of the signals	See annex H
3.2	Relationship between counters	See annex H
4	Timing of transmitted signals	See annex H
5.5	Maximum timing advance value	See annex H
5.6.1	For circuit switched channels	N/A
6	MS Requirements for Synchronization	See annex H
6.4	Timing of transmission	See annex H
6.5.1	For circuit switched channels	N/A
6.12	Observed Frequency Offset (OFO) reported by the CTS-MS	N/A
7	CTS-FP Requirements for Synchronization	N/A
7.1	Frequency source default requirements	N/A
7.2	Frequency source for a CTS-FP assisted by a CTS-MS	N/A
7.3	Internal CTS-FP carrier timing	N/A
7.4	Timeslot length	N/A
7.5	Assessment of CTS-MS delay	N/A
A.1.1	Conventions	See annex H
B.1	Determination of TN by the CTS-MS when CTSBCH shifting is not active	N/A
B.2	Determination of TN by the CTS-MS when CTSBCH shifting is active	N/A

## 4.14 Applicability of GSM 08.02

GSM 08.02 is applicable, except as described in table 14.

**Table 14: Applicability of clauses from GSM 08.02 to TAPS**

Clause	Name	Status
2.2.4	DCCH Management	N/A
2.2.4.1	DCCH link supervision	N/A
2.2.4.2	DCCH channel release	N/A
2.2.4.3	DCCH power control	N/A
2.2.4.4	Radio Channel Allocation	N/A
2.5	Transcoding/rate adaptation	N/A
2.6	Interworking function (data calls)	N/A
2.10	Call control	N/A
3	Transcoder/rate adapter integration	N/A
6	Support of services and features other than speech	N/A
6.1	Data services	N/A
6.2	Supplementary services	N/A

## 4.15 Applicability of GSM 08.08

GSM 08.08 is applicable, except as described in table 15.

**Table 15: Applicability of clauses from GSM 08.08 to TAPS**

Clause	Name	Status
3.1.21	Voice group call service and voice broadcast service call set-up and resource assignment	N/A
3.1.21.1	Successful operation	N/A
3.1.21.2	VGCS/VBS call set-up abnormal cases	N/A
3.1.21.3	VGCS/VBS call set-up failure	N/A
3.1.22	Voice group call service and voice broadcast service Assignment procedure	N/A
3.1.22.1	Successful operation	N/A
3.1.22.2	VGCS/VBS Assignment abnormal cases	N/A
3.1.22.3	VGCS/VBS Assignment failure	N/A
3.1.23	Spare	N/A
3.1.24	Voice group call uplink control procedure	N/A
3.1.24.1	Uplink allocation procedure	N/A
3.1.24.1.1	Successful uplink allocation operation	N/A
3.1.24.1.2	Unsuccessful uplink allocation operation	N/A
3.1.24.2	Uplink release procedure	N/A
3.1.24.3	Uplink seize procedure	N/A
3.1.25	PDSS1 flow control	N/A
3.2.1.50	VGCS/VBS SETUP	N/A
3.2.1.51	VGCS/VBS SETUP ACK	N/A
3.2.1.52	VGCS/VBS SETUP REFUSE	N/A
3.2.1.53	VGCS/VBS ASSIGNMENT REQUEST	N/A
3.2.1.54	VGCS/VBS ASSIGNMENT RESULT	N/A
3.2.1.55	VGCS/VBS ASSIGNMENT FAILURE	N/A
3.2.1.56	VGCS/VBS QUEUING INDICATION	N/A
3.2.1.57	UPLINK REQUEST	N/A
3.2.1.58	UPLINK REQUEST ACKNOWLEDGE	N/A
3.2.1.59	UPLINK REQUEST CONFIRMATION	N/A
3.2.1.60	UPLINK RELEASE INDICATION	N/A
3.2.1.61	UPLINK REJECT COMMAND	N/A
3.2.1.62	UPLINK RELEASE COMMAND	N/A
3.2.1.63	UPLINK SEIZED COMMAND	N/A

## 4.16 Applicability of GSM 08.52

GSM 08.52 is applicable, except as described in table 16.

**Table 16: Applicability of clauses from GSM 08.52 to TAPS**

Clause	Name	Status
4.3.6	Transcoding/rate adaption	N/A
5	Transcoding/rate adaption and multiplexing	N/A
5.1	Transcoding/rate adaption in BTS	N/A
5.2	Transcoding/rate adaption outside BTS	N/A
6	Interface structures	N/A
6.1	Communication channels	N/A
6.2	Signalling links	N/A
6.3	Signalling model	N/A

## 4.17 Applicability of GSM 08.58

GSM 08.58 is applicable, except as described in table 17.

**Table 17: Applicability of clauses from GSM 08.58 to TAPS**

Clause	Name	Status
4.13	Talker detection	N/A
4.14	Listener detection	N/A
4.15	Remote Codec Configuration	N/A
4.16	Round Trip Delay Report	N/A
4.17	Pre-handover Warning	N/A
4.18	MultiRate Codec Configuration Change	N/A
4.19	MultiRate Codec Configuration Change Performed	N/A
4.20	TFO Report	N/A
4.21	TFO Modification Request	N/A

## 4.18 Applicability of GSM 11.11

GSM 11.11 is applicable, except as described in table 18.

**Table 18: Applicability of clauses from GSM 11.11 to TAPS**

Clause	Name	Status
11.5.1	Dialling numbers	N/A
11.5.3	Advice of Charge (AoC)	N/A
11.5.4	Capability configuration parameters	N/A
11.5.10	Voice Group Call Services	N/A
11.5.11	Voice Broadcast Services	N/A
11.5.12	Enhanced Multi Level Pre-emption and Priority Service	N/A
11.5.16	Network's indication of alerting	N/A
11.6.14	Call Control	N/A
Annex H	Coding of EFs for N/AM and GSM-AMPS Operational Parameters	N/A
H.1	Elementary File Definitions and Contents	N/A
H.1.1	EF <sub>MIN</sub> (Mobile Identification Number)	N/A
H.1.2	EF <sub>ACCOLC</sub> (Access Overload Class)	N/A
H.1.3	EF <sub>SID</sub> (System ID Of Home System)	N/A
H.1.4	EF <sub>IPC</sub> (Initial Paging Channel)	N/A
H.1.5	EF <sub>GPI</sub> (Group ID)	N/A
H.1.6	EF <sub>S-ESN</sub> (SIM Electronic Serial Number)	N/A
H.1.7	EF <sub>COUNT</sub> (Call Count)	N/A
H.1.8	EF <sub>PSID</sub> (Positive/Favoured SID list)	N/A
H.1.9	EF <sub>NSID</sub> (Negative/Forbidden SID List)	N/A
H.1.10	EF <sub>SPL</sub> (Scanning Priority List)	N/A



Clause	Name	Status
H.1.11	EF <sub>NETSEL</sub> (Network Selection Activation Flag)	N/A
H.1.12	EF <sub>CSID</sub> (Current/Last Registered SID)	N/A
H.1.13	EF <sub>REG-THRESH</sub> (Registration Threshold)	N/A
H.1.14	EF <sub>CCCH</sub> (Current Control Channel)	N/A
H.1.15	EF <sub>LdCC</sub> (Latest DCC)	N/A
H.1.16	EF <sub>GSM-RECON</sub> (GSM Reconnect Timer)	N/A
H.1.17	EF <sub>AMPS-2-GSM</sub> (AMPS to GSM Rescan Timing Table)	N/A
H.1.18	EF <sub>FC1</sub> (Feature Activation Codes)	N/A
H.1.19	EF <sub>AMPS-UI</sub> (AMPS USAGE INDICATORS)	N/A
H.2	Authentication Functionality	N/A
H.2.1	A-KEY (ANSI-41 Authentication Key)	N/A
H.2.2	SSD (Shared Secret Data)	N/A
H.3	Authentication commands	N/A
H.3.1	Generation of Authentication Signature Data and Ciphering Keys	N/A
H.3.2	Validation and Storage of Entered A-Key's	N/A
H.3.3	Ask Random Task	N/A
H.3.4	Update Shared Secret Data	N/A
H.3.5	Confirm Shared Secret Data	N/A
H.3.6	CMEA Encryption of Voice Channel Data Digits	N/A
H.3.7	SIM Status Codes	N/A

## 4.19 Applicability of GSM 11.14

GSM 11.14 is applicable, except as described in table 19.

**Table 19: Applicability of clauses from GSM 11.14 to TAPS**

Clause	Name	Status
4.5	Call control by SIM	N/A
6.4.11	SEND SS	N/A
6.4.12	SEND USSD	N/A
6.4.13	SET UP CALL	N/A
6.4.24	SEND DTMF	N/A
6.4.27.1	OPEN CHANNEL for CSD	N/A
6.6.11	SEND USSD	N/A
6.6.12	SET UP CALL	N/A
6.6.24	SEND DTMF COMMAND	N/A
6.6.27.1	OPEN CHANNEL related to a CS bearer	N/A
9.1	Call Control by SIM	N/A
9.1.1	Procedure for mobile originated calls	N/A
9.1.2	Procedure for Supplementary Services and USSD	N/A
9.1.3	Indication to be given to the user	N/A
9.1.4	Interaction with Fixed Dialling Number	N/A
9.1.5	Support of Barred Dialling Number (BDN) service	N/A
9.1.6	Structure of ENVELOPE (CALL CONTROL)	N/A
11.1	MT call event	N/A
11.1.1	Procedure	N/A
11.1.2	Structure of ENVELOPE (EVENT DOWNLOAD - MT call)	N/A
11.2	Call connected event	N/A
11.2.1	Procedure	N/A
11.2.2	Structure of ENVELOPE (EVENT DOWNLOAD - Call connected)	N/A
11.3	Call disconnected event	N/A
11.3.1	Procedure	N/A
11.3.2	Structure of ENVELOPE (EVENT DOWNLOAD - Call disconnected)	N/A
11.11	Channel status event	N/A
11.11.1	Procedure	N/A
11.11.2	Structure of ENVELOPE (EVENT DOWNLOAD - Channel status)	N/A
12.12.1	Additional information for SEND SS	N/A
12.12.4	Additional information for SS problem	N/A
12.14	SS string	N/A
12.44	DTMF string	N/A
12.52.1	Bearer parameters for CSD	N/A

## 4.20 Applicability of TS 22.030

TS 22.030 is applicable, except as described in table 20.

**Table 20: Applicability of clauses from TS 22.030 to TAPS**

Clause	Name	Status
6.4	Call Control	N/A
6.4.1	General	N/A
6.4.2	Voice calls	N/A
6.4.2.1	Mobile originated calls	N/A
6.4.2.2	Emergency calls	N/A
6.4.2.3	Mobile terminated calls	N/A
6.5	Supplementary Services Control	N/A
6.5.1	General	N/A
6.5.2	Structure of the MMI	N/A
6.5.3	Handling of supplementary services	N/A
6.5.3.1	Handling of defined supplementary services	N/A
6.5.3.2	Handling of not-implemented supplementary services	N/A
6.5.4	Registration of new password	N/A
6.5.5	Handling of supplementary services within a call	N/A
6.5.5.1	Call Deflection, Call Waiting, Call Hold, MultiParty Services, Explicit Call Transfer and Completion of Calls to Busy Subscriber general principles	N/A
6.5.5.2	Call Waiting (CW)	N/A
6.5.5.3	Call hold	N/A
6.5.5.4	MultiParty	N/A
6.5.5.5	Explicit Call Transfer	N/A
6.5.5.6	Special case	N/A
6.5.5.7	Call Deflection	N/A
6.5.5.8	Completion of calls to busy subscribers	N/A
6.5.6	Other handling of supplementary services	N/A
6.5.6.1	Multiple Subscriber Profile	N/A
6.5.6.1.1	Registering an alternative profile	N/A
6.5.6.1.2	Selecting an alternative profile on a per call basis	N/A
6.5.6.2	Calling Line Identification Presentation (CLIP)	N/A
6.6.6.2.1	Presentation of Information	N/A
6.5.6.3	Follow Me (FM)	N/A
Annex B	Codes for defined Supplementary Services	N/A

## 4.21 Applicability of TS 22.038

TS 22.038 is applicable, except as described in table 21.

**Table 21: Applicability of clauses from TS 22.038 to TAPS**

Clause	Name	Status
14	Interaction with supplementary services	N/A
14.1	General	N/A
14.2	Line Identification	N/A
14.2.1	Calling Line Identification Presentation (CLIP)	N/A
14.2.2	Calling Line Identification Restriction (CLIR)	N/A
14.2.3	Connected Line Identification Presentation (COLP)	N/A
14.2.4	Connected Line Identification Restriction (COLR)	N/A
14.3	Call Forwarding	N/A
14.3.1	Call Forwarding Unconditional (CFU)	N/A
14.3.2	Call Forwarding Busy (CFB)	N/A
14.3.3	Call Forwarding on No Reply (CFNRy)	N/A
14.3.4	Call Forwarding on Not Reachable (CFNRc)	N/A
14.4	Call Completion	N/A
14.4.1	Call Hold (CH)	N/A
14.4.2	Call Waiting (CW)	N/A
14.5	Multi Party (MPTY)	N/A

Clause	Name	Status
14.6	Closed User Group (CUG)	N/A
14.7	Advice of Charge (AoC)	N/A
14.8	Call Barring	N/A
14.8.1	Barring of all outgoing calls	N/A
14.8.2	Barring of outgoing international calls	N/A
14.8.2.1	Mobile originated calls	N/A
14.8.2.2	Forwarded Calls	N/A
14.8.3	Barring of outgoing international calls except those directed to the HPLMN country	N/A
14.8.4	Barring of all incoming calls	N/A
14.8.5	Barring of incoming calls when roaming	N/A
14.9	Explicit Call Transfer (ECT)	N/A
14.10	Completion of Call to Busy Subscriber (CCBS)	N/A
14.11	Multiple Subscriber Profile (MSP)	N/A
15	Interaction with network features	N/A
15.1	Interactions with Operator Determined Barring (ODB)	N/A
15.1.1	Barring of all outgoing calls	N/A
15.1.2	Barring of all outgoing international calls	N/A
15.1.3	Barring of all outgoing international calls except those directed to the home PLMN country	N/A
15.1.4	Barring of outgoing calls when roaming outside the home PLMN country	N/A
15.1.5	Barring of outgoing premium rate calls	N/A
15.1.6	Barring of incoming calls	N/A
15.1.7	Barring of incoming calls when roaming outside the home PLMN country	N/A
15.1.8	Operator Specific Barring	N/A
15.1.9	Barring of Supplementary Services Management	N/A
15.2	Interactions with Optimal Routing (OR)	N/A
15.3	Interactions with MExE	N/A
15.4	Interactions with CAMEL	N/A

## 4.22 Applicability of TS 23.002

TS 23.002 is applicable, except as described in table 22.

**Table 22: Applicability of clauses from TS 23.002 to TAPS**

Clause	Name	Status
3.3.1	CS Domain	N/A
4a.1	The Group Call Register (GCR) entity	N/A
4a.2	The Shared InterWorking Function (SIWF) entity	N/A
6.4.1	Interfaces internal to the CS domain	N/A
6.4.1.1	Interface between the MSC and its associated VLR (B-interface)	N/A
6.4.1.2	Interface between the HLR and the MSC (C-interface)	N/A
6.4.1.3	Interface between the HLR and the VLR (D-interface)	N/A
6.4.1.4	Interface between MSCs (E-interface)	N/A
6.4.1.5	Interface between MSC and EIR (F-interface)	N/A
6.4.1.6	Interface between VLRs (G-interface)	N/A

## 4.23 Applicability of TS 23.016

## 4.24 Applicability of TS 24.007

TS 24.007 is applicable, except as described in table 24.

**Table 24: Applicability of clauses from TS 24.007 to TAPS**

Clause	Name	Status
6.2	Call Control services	N/A
6.2.1	Service state diagram	N/A
6.2.2	Service primitives	N/A
6.2.2.1	MNCC_SETUP_REQ	N/A
6.2.2.2	MNCC_SETUP_IND	N/A
6.2.2.3	MNCC_SETUP_RES	N/A
6.2.2.4	MNCC_SETUP_CNF	N/A
6.2.2.5	MNCC_SETUP_COMPL_REQ	N/A
6.2.2.6	MNCC_SETUP_COMPL_IND	N/A
6.2.2.7	MNCC_REJ_REQ	N/A
6.2.2.8	MNCC_REJ_IND	N/A
6.2.2.9	MNCC_CALL_CONF_REQ	N/A
6.2.2.10	MNCC_CALL_PROC_IND	N/A
6.2.2.11	MNCC_PROGRESS_IND	N/A
6.2.2.12	MNCC_ALERT_REQ	N/A
6.2.2.13	MNCC_ALERT_IND	N/A
6.2.2.14	MNCC_NOTIFY_REQ	N/A
6.2.2.15	MNCC_NOTIFY_IND	N/A
6.2.2.16	MNCC_DISC_REQ	N/A
6.2.2.17	MNCC_DISC_IND	N/A
6.2.2.18	MNCC_REL_REQ	N/A
6.2.2.19	MNCC_REL_IND	N/A
6.2.2.20	MNCC_REL_CNF	N/A
6.2.2.21	MNCC_FACILITY_REQ	N/A
6.2.2.22	MNCC_FACILITY_IND	N/A
6.2.2.23	MNCC_START_DTMF_REQ	N/A
6.2.2.24	MNCC_START_DTMF_CNF	N/A
6.2.2.25	MNCC_STOP_DTMF_REQ	N/A
6.2.2.26	MNCC_STOP_DTMF_CNF	N/A
6.2.2.27	MNCC_MODIFY_REQ	N/A
6.2.2.28	MNCC_MODIFY_IND	N/A
6.2.2.29	MNCC_MODIFY_RES	N/A
6.2.2.30	MNCC_MODIFY_CNF	N/A
6.2.2.31	MNCC_SYNC_IND	N/A
6.3	Call independent Supplementary Services Support	N/A
6.3.1	Service state diagram	N/A
6.3.2	Service primitives	N/A
6.3.2.1	MNSS_BEGIN_REQ	N/A
6.3.2.2	MNSS_BEGIN_IND	N/A
6.3.2.3	MNSS_FACILITY_REQ	N/A
6.3.2.4	MNSS_FACILITY_IND	N/A
6.3.2.5	MNSS_END_REQ	N/A
6.3.2.6	MNSS_END_IND	N/A
7.1	Call control services	N/A
7.1.1	Service state diagram	N/A
7.1.2	Service primitives	N/A
7.1.2.1	MNCC_SETUP_REQ	N/A
7.1.2.2	MNCC_SETUP_IND	N/A
7.1.2.3	MNCC_SETUP_RSP	N/A
7.1.2.4	MNCC_SETUP_CNF	N/A
7.1.2.5	MNCC_SETUP_COMPL_REQ	N/A
7.1.2.6	MNCC_SETUP_COMPL_IND	N/A
7.1.2.7	MNCC_REJ_REQ	N/A
7.1.2.8	MNCC_REJ_IND	N/A

Clause	Name	Status
7.1.2.9	MNCC_CALL_CONF_IND	N/A
7.1.2.10	MNCC_CALL_PROC_REQ	N/A
7.1.2.11	MNCC_PROGRESS_REQ	N/A
7.1.2.12	MNCC_ALERT_REQ	N/A
7.1.2.13	MNCC_ALERT_IND	N/A
7.1.2.14	MNCC_NOTIFY_REQ	N/A
7.1.2.15	MNCC_NOTIFY_IND	N/A
7.1.2.16	MNCC_DISC_REQ	N/A
7.1.2.17	MNCC_DISC_IND	N/A
7.1.2.18	MNCC_REL_REQ	N/A
7.1.2.19	MNCC_REL_IND	N/A
7.1.2.20	MNCC_REL_CNF	N/A
7.1.2.21	MNCC_FACILITY_REQ	N/A
7.1.2.22	MNCC_FACILITY_IND	N/A
7.1.2.23	MNCC_START_DTMF_IND	N/A
7.1.2.24	MNCC_START_DTMF_RSP	N/A
7.1.2.25	MNCC_STOP_DTMF_IND	N/A
7.1.2.26	MNCC_STOP_DTMF_RSP	N/A
7.1.2.27	MNCC_MODIFY_REQ	N/A
7.1.2.28	MNCC_MODIFY_IND	N/A
7.1.2.29	MNCC_MODIFY_RES	N/A
7.1.2.30	MNCC_MODIFY_CNF	N/A
7.2	Call independent Supplementary Services Support	N/A
7.2.1	Service state diagram	N/A
7.2.2	Service primitives	N/A
7.2.2.1	MNSS_BEGIN_REQ	N/A
7.2.2.2	MNSS_BEGIN_IND	N/A
7.2.2.3	MNSS_FACILITY_REQ	N/A
7.2.2.4	MNSS_FACILITY_IND	N/A
7.2.2.5	MNSS_END_REQ	N/A
7.2.2.6	MNSS_END_IND	N/A

## 4.25 Applicability of TS 24.008

TS 24.008 is applicable, except as described in table 25 and annex I.

**Table 25: Applicability of clauses from TS 24.008 to TAPS**

Clause	Name	Status
1.2	Application to the interface structures	See annex I
1.4	Test procedures	N/A
1.5	Use of logical channels in A/Gb mode	See annex I
1.6.1	List of procedures	See annex I
1.7.1	Voice Group Call Service (VGCS) and Voice Broadcast Service (VBS)	N/A
1.7.2.1	Packet services in GSM (GSM only)	See annex I
1.7.2.2	Packet services in UMTS (UMTS only)	N/A
2.2.2	Vocabulary	See annex I
4.1	General	See annex I
4.1.1.1	Types of MM and GMM procedures	See annex I
4.1.1.1.1	Integrity Checking of Signalling Messages in the Mobile Station (UMTS only)	N/A
4.1.1.1.1a	Integrity protection for emergency call (UMTS only)	N/A
4.1.1.2	MM-GMM co-ordination for GPRS MS's	N/A
4.1.1.2.1	GPRS MS operating in mode A or B in a network that operates in mode I	N/A
4.1.1.2.2	GPRS MS operating in mode A or B in a network that operates in mode II or III	N/A
4.1.1.3	Core Network System Information for MM (UMTS only)	N/A
4.1.1.4	Core Network System Information for GMM (UMTS only)	N/A
4.1.2.1	MM sublayer states in the mobile station	See annex I
4.1.2.1.1	Main states	See annex I
4.1.2.1.2	Substates of the MM IDLE state	See annex I
4.1.2.2	The update Status	See annex I
4.1.2.3	MM sublayer states on the network side	See annex I

Clause	Name	Status
4.1.3.1	GMM states in the MS	See annex I
4.1.3.2	GPRS update status	See annex I
4.2.1.2	Other Cases	See annex I
4.2.2	Detailed Description of the MS behaviour in MM IDLE State	See annex I
4.2.2.1	Service State, NORMAL SERVICE	See annex I
4.2.2.2	Service State, ATTEMPTING TO UPDATE	See annex I
4.2.2.3	Service State, LIMITED SERVICE	See annex I
4.2.2.4	Service State, NO IMSI	See annex I
4.2.2.5	Service State, SEARCH FOR PLMN, NORMAL SERVICE	See annex I
4.2.2.6	Service State, SEARCH FOR PLMN	See annex I
4.2.2.7	Service State, RECEIVING GROUP CALL (NORMAL SERVICE)	N/A
4.2.2.8	Service State, RECEIVING GROUP CALL (LIMITED SERVICE)	N/A
4.2.3	Service state when back to state MM IDLE from another state	See annex I
4.2.4	Behaviour in state GMM-DEREGISTERED	See annex I
4.2.4.1.1	Selection of the substate after power on or enabling the MS's GPRS capability	See annex I
4.2.4.2.2	Substate, ATTEMPTING-TO-ATTACH	See annex I
4.2.4.3	Substate when back to state GMM-DEREGISTERED from another GMM state	See annex I
4.2.5.1.1	Substate, NORMAL-SERVICE	See annex I
4.2.5.1.4	Substate, ATTEMPTING-TO-UPDATE	See annex I
4.2.5.1.7	Substate, ATTEMPTING-TO-UPDATE-MM	See annex I
4.3.1	TMSI reallocation procedure	See annex I
4.3.1.1	TMSI reallocation initiation by the network	See annex I
4.3.1.3	TMSI reallocation completion in the network	See annex I
4.3.2a	Authentication procedure used for a UMTS authentication challenge	N/A
4.3.2b	Authentication Procedure used for a GSM authentication challenge	See annex I
4.3.2.1	Authentication request by the network	See annex I
4.3.2.2	Authentication response by the mobile station	See annex I
4.3.2.3	Authentication processing in the network	See annex I
4.3.2.4	Ciphering key sequence number	See annex I
4.3.2.5	Authentication not accepted by the network	See annex I
4.3.2.5.1	Authentication not accepted by the MS	N/A
4.3.2.7	Handling of keys at intersystem change from UMTS to GSM	N/A
4.3.2.7a	Use of established security contexts	N/A
4.3.2.8	Handling of keys at intersystem change from GSM to UMTS	N/A
4.3.3.3	Abnormal cases	See annex I
4.3.4	IMSI detach procedure	See annex I
4.3.4.2	IMSI detach procedure in the network	See annex I
4.4.1	Location updating procedure	See annex I
4.4.2	Periodic updating	See annex I
4.4.3	IMSI attach procedure	See annex I
4.4.4.1	Location updating initiation by the mobile station	See annex I
4.4.4.4	Security mode setting by the network	See annex I
4.4.4.8	Release of RR connection after location updating	See annex I
4.5	Connection management sublayer service provision	See annex I
4.5.1.1	MM connection establishment initiated by the mobile station	See annex I
4.5.1.3.1	Mobile Terminating CM Activity	See annex I
4.5.1.3.2	Mobile Originating CM Activity \$(CCBS)\$	See annex I
4.5.1.3.3	Paging response in UMTS (UMTS only)	N/A
4.5.1.5	MM connection establishment for emergency calls	N/A
4.5.1.6	Call re-establishment	N/A
4.5.1.6.1	Call re-establishment, initiation by the mobile station	N/A
4.5.1.6.2	Abnormal cases	N/A
4.5.1.7	Forced release during MO MM connection establishment	See annex I
4.5.3.2	Uplink release in a voice group call	N/A
4.7.1.4	Radio resource sublayer address handling	See annex I
4.7.1.4.1	Radio resource sublayer address handling (GSM only)	See annex I
4.7.1.5.2	PTMSI handling in UMTS	N/A
4.7.1.6	Change of network mode of operation	N/A
4.7.1.6.1	Change of network mode of operation in GSM (GSM only)	N/A
4.7.1.6.2	Change of network mode of operation in UMTS (UMTS only)	N/A
4.7.1.6.3	Change of network mode of operation at UMTS to GSM inter-system change	N/A
4.7.1.6.4	Change of network mode of operation at GSM to UMTS inter-system change	N/A
4.7.1.7	Intersystem change between GSM and UMTS	N/A
4.7.2	GPRS Mobility management timers and UMTS PS signalling connection	See annex I

Clause	Name	Status
	control	
4.7.2.1.2	Handling of READY timer in UMTS (UMTS only)	N/A
4.7.2.2	Periodic routing area updating	See annex I
4.7.2.3	PMM-IDLE mode and PMM-CONNECTED mode (UMTS only)	N/A
4.7.2.4	Handling of Force to standby in UMTS (UMTS only)	N/A
4.7.3	GPRS attach procedure	See annex I
4.7.3.1.1	GPRS attach procedure initiation	See annex I
4.7.3.1.3	GPRS attach accepted by the network	See annex I
4.7.3.1.5	Abnormal cases in the MS	See annex I
4.7.3.1.6	Abnormal cases on the network side	See annex I
4.7.3.2	Combined GPRS attach procedure for GPRS and non-GPRS services	N/A
4.7.3.2.1	Combined GPRS attach procedure initiation	N/A
4.7.3.2.2	GMM Common procedure initiation	N/A
4.7.3.2.3	Combined GPRS attach accepted by the network	N/A
4.7.3.2.4	Combined GPRS attach not accepted by the network	N/A
4.7.3.2.5	Abnormal cases in the MS	N/A
4.7.3.2.6	Abnormal cases on the network side	N/A
4.7.4	GPRS detach procedure	See annex I
4.7.4.1.1	MS initiated GPRS detach procedure initiation	See annex I
4.7.4.1.2	MS initiated GPRS detach procedure completion for GPRS services only	See annex I
4.7.4.1.3	MS initiated combined GPRS detach procedure completion	N/A
4.7.4.2.2	Network initiated GPRS detach procedure completion by the MS	See annex I
4.7.5	Routing area updating procedure	See annex I
4.7.5.1	Normal and periodic routing area updating procedure	See annex I
4.7.5.1.1	Normal and periodic routing area updating procedure initiation	See annex I
4.7.5.1.3	Normal and periodic routing area updating procedure accepted by the network	See annex I
4.7.5.1.5	Abnormal cases in the MS	See annex I
4.7.5.1.6	Abnormal cases on the network side	See annex I
4.7.5.2	Combined routing area updating procedure	N/A
4.7.5.2.1	Combined routing area updating procedure initiation	N/A
4.7.5.2.2	GMM Common procedure initiation	N/A
4.7.5.2.3	Combined routing area updating procedure accepted by the network	N/A
4.7.5.2.4	Combined routing area updating not accepted by the network	N/A
4.7.5.2.5	Abnormal cases in the MS	N/A
4.7.5.2.6	Abnormal cases on the network side	N/A
4.7.7a	Authentication and ciphering procedure used for UMTS authentication challenge.	N/A
4.7.7b	Authentication and ciphering procedure used for GSM authentication challenge	See annex I
4.7.7.1	Authentication and ciphering initiation by the network	See annex I
4.7.7.2	Authentication and ciphering response by the MS	See annex I
4.7.7.3	Authentication and ciphering completion by the network	See annex I
4.7.7.4	GPRS ciphering key sequence number	See annex I
4.7.7.5.1	Authentication not accepted by the MS	N/A
4.7.7.7	Use of established security contexts	See annex I
4.7.7.8	Handling of keys at intersystem change from UMTS to GSM	N/A
4.7.7.9	Handling of keys at intersystem change from GSM to UMTS	N/A
4.7.9.1	Paging for GPRS services	See annex I
4.7.9.1.1	Paging for GPRS services using P-TMSI	See annex I
4.7.9.1.2	Paging for GPRS services using IMSI	See annex I
4.7.9.2	Paging for non-GPRS services	See annex I
4.7.13	Service Request procedure (UMTS only)	N/A
4.7.13.1	Service Request procedure initiation	N/A
4.7.13.2	GMM common procedure initiation	N/A
4.7.13.3	Service request procedure accepted by the network	N/A
4.7.13.4	Service request procedure not accepted by the network	N/A
4.7.13.5	Abnormal cases in the MS	N/A
4.7.13.6	Abnormal cases on the network side	N/A
5	Elementary procedures for circuit-switched Call control	N/A
5.1	Overview	N/A
5.1.1	General	N/A
5.1.2	Call control States	N/A
5.1.2.1	Call states at the mobile station side of the interface	N/A
5.1.2.1.1	Null (State U0)	N/A

Clause	Name	Status
5.1.2.1.2	MM Connection pending (U0.1)	N/A
5.1.2.1.2a	CC prompt present (U0.2) \$(CCBS)\$	N/A
5.1.2.1.2b	Wait for network information (U0.3) \$(CCBS)\$	N/A
5.1.2.1.2c	CC-Establishment present (U0.4) \$(CCBS)\$	N/A
5.1.2.1.2d	CC-Establishment confirmed (U0.5) \$(CCBS)\$	N/A
5.1.2.1.2e	Recall present (U0.6) \$(CCBS)\$	N/A
5.1.2.1.3	Call initiated (U1)	N/A
5.1.2.1.4	Mobile originating call proceeding (U3)	N/A
5.1.2.1.5	Call delivered (U4)	N/A
5.1.2.1.6	Call present (U6)	N/A
5.1.2.1.7	Call received (U7)	N/A
5.1.2.1.8	Connect Request (U8)	N/A
5.1.2.1.9	Mobile terminating call confirmed (U9)	N/A
5.1.2.1.10	Active (U10)	N/A
5.1.2.1.11	Disconnect request (U11)	N/A
5.1.2.1.12	Disconnect indication (U12)	N/A
5.1.2.1.13	Release request (U19)	N/A
5.1.2.1.14	Mobile originating modify (U26)	N/A
5.1.2.1.15	Mobile terminating modify (U27)	N/A
5.1.2.2	Network call states	N/A
5.1.2.2.1	Null (State N0)	N/A
5.1.2.2.2	MM connection pending (N0.1)	N/A
5.1.2.2.2a	CC connection pending (N0.2) \$(CCBS)\$	N/A
5.1.2.2.2b	Network answer pending (N0.3) \$(CCBS)\$	N/A
5.1.2.2.2c	CC-Establishment present (N0.4) \$(CCBS)\$	N/A
5.1.2.2.2d	CC-Establishment confirmed (N0.5) \$(CCBS)\$	N/A
5.1.2.2.3	Call initiated (N1)	N/A
5.1.2.2.4	Mobile originating call proceeding (N3)	N/A
5.1.2.2.5	Call delivered (N4)	N/A
5.1.2.2.6	Call present (N6)	N/A
5.1.2.2.7	Call received (N7)	N/A
5.1.2.2.8	Connect request (N8)	N/A
5.1.2.2.9	Mobile terminating call confirmed (N9)	N/A
5.1.2.2.10	Active (N10)	N/A
5.1.2.2.11	Not used	N/A
5.1.2.2.12	Disconnect indication (N12)	N/A
5.1.2.2.13	Release request (N19)	N/A
5.1.2.2.14	Mobile originating modify (N26)	N/A
5.1.2.2.15	Mobile terminating modify (N27)	N/A
5.1.2.2.16	Connect Indication (N28)	N/A
5.2	Call establishment procedures	N/A
5.2.1	Mobile originating call establishment	N/A
5.2.1.1	Call initiation	N/A
5.2.1.2	Receipt of a setup message	N/A
5.2.1.3	Receipt of a CALL PROCEEDING message	N/A
5.2.1.4	Notification of progressing mobile originated call	N/A
5.2.1.4.1	Notification of interworking in connection with mobile originated call establishment	N/A
5.2.1.4.2	Call progress in the PLMN/ISDN environment	N/A
5.2.1.5	Alerting	N/A
5.2.1.6	Call connected	N/A
5.2.1.7	Call rejection	N/A
5.2.1.8	Transit network selection	N/A
5.2.1.9	Traffic channel assignment at mobile originating call establishment	N/A
5.2.1.10	Call queuing at mobile originating call establishment	N/A
5.2.2	Mobile terminating call establishment	N/A
5.2.2.1	Call indication	N/A
5.2.2.2	Compatibility checking	N/A
5.2.2.3	Call confirmation	N/A
5.2.2.3.1	Response to SETUP	N/A
5.2.2.3.2	Receipt of CALL CONFIRMED and ALERTING by the network	N/A
5.2.2.3.3	Call failure procedures	N/A
5.2.2.3.4	Called mobile station clearing during mobile terminating call establishment	N/A



Clause	Name	Status
5.2.2.4	Notification of interworking in connection with mobile terminating call establishment	N/A
5.2.2.5	Call accept	N/A
5.2.2.6	Active indication	N/A
5.2.2.7	Traffic channel assignment at mobile terminating call establishment	N/A
5.2.2.8	Call queuing at mobile terminating call establishment	N/A
5.2.2.9	User connection attachment during a mobile terminating call	N/A
5.2.3	Network initiated MO call \$(CCBS)\$	N/A
5.2.3.1	Initiation	N/A
5.2.3.2	CC-Establishment present	N/A
5.2.3.2.1	Recall Alignment Procedure	N/A
5.2.3.3	CC-Establishment confirmation	N/A
5.2.3.4	Recall present	N/A
5.2.3.5	Traffic channel assignment during network initiated mobile originating call establishment	N/A
5.3	Signalling procedures during the "active" state	N/A
5.3.1	User notification procedure	N/A
5.3.2	Call rearrangements	N/A
5.3.3	Not used	N/A
5.3.4	Support of Dual Services	N/A
5.3.4.1	Service Description	N/A
5.3.4.2	Call establishment	N/A
5.3.4.2.1	Mobile Originating Establishment	N/A
5.3.4.2.2	Mobile Terminating Establishment	N/A
5.3.4.3	Changing the Call Mode	N/A
5.3.4.3.1	Initiation of in-call modification	N/A
5.3.4.3.2	Successful completion of in-call modification	N/A
5.3.4.3.3	Change of the channel configuration	N/A
5.3.4.3.4	Failure of in-call modification	N/A
5.3.4.4	Abnormal procedures	N/A
5.3.5	User initiated service level up- and downgrading (GSM only)	N/A
5.3.5.1	Initiation of service level up- and downgrading	N/A
5.3.5.2	Successful completion of service level up- and downgrading	N/A
5.3.5.3	Rejection of service level up- and downgrading	N/A
5.3.5.4	Time-out recovery	N/A
5.3.6	Support of multimedia calls	N/A
5.3.6.1	Service description	N/A
5.3.6.2	Call establishment	N/A
5.3.6.2.1	Mobile originated multimedia call establishment	N/A
5.3.6.2.2	Mobile terminating multimedia call	N/A
5.3.6.3	In-call modification in the "active" state	N/A
5.3.6.3.1	Initiation of in-call modification	N/A
5.3.6.3.2	Successful completion of in-call modification	N/A
5.3.6.3.3	Failure of in-call modification	N/A
5.4	Call clearing	N/A
5.4.1	Terminology	N/A
5.4.2	Exception conditions	N/A
5.4.3	Clearing initiated by the mobile station	N/A
5.4.3.1	Initiation of call clearing	N/A
5.4.3.2	Receipt of a DISCONNECT message from the mobile station	N/A
5.4.3.3	Receipt of a RELEASE message from the network	N/A
5.4.3.4	Receipt of a RELEASE COMPLETE message from the mobile station	N/A
5.4.3.5	Abnormal cases	N/A
5.4.4	Clearing initiated by the network	N/A
5.4.4.1	Clearing initiated by the network: mobile does not support "Prolonged Clearing Procedure"	N/A
5.4.4.1.1	Clearing when tones/announcements provided	N/A
5.4.4.1.2	Clearing when tones/announcements not provided	N/A
5.4.4.1.3	Completion of clearing	N/A
5.4.4.2	Clearing initiated by the network: mobile supports "Prolonged Clearing Procedure"	N/A
5.4.4.2.1	Clearing when tones/announcements provided and the network does not indicate that "CCBS activation is possible"	N/A
5.4.4.2.2	Clearing when the network indicates that "CCBS activation is possible"	N/A

Clause	Name	Status
5.4.4.2.3	Clearing when tones/announcements are not provided and the network does not indicate that "CCBS activation is possible"	N/A
5.4.4.2.4	Receipt of a RELEASE message from the mobile station	N/A
5.4.4.2.5	Completion of clearing	N/A
5.5	Miscellaneous procedures	N/A
5.5.1	In-band tones and announcements	N/A
5.5.2	Call collisions	N/A
5.5.3	Status procedures	N/A
5.5.3.1	Status enquiry procedure	N/A
5.5.3.2	Reception of a STATUS message by a CC entity	N/A
5.5.3.2.1	STATUS message with incompatible state	N/A
5.5.3.2.2	STATUS message with compatible state	N/A
5.5.4	Call re-establishment, mobile station side	N/A
5.5.4.1	Indication from the mobility management sublayer	N/A
5.5.4.2	Reaction of call control	N/A
5.5.4.3	Completion of re-establishment	N/A
5.5.4.4	Unsuccessful outcome	N/A
5.5.5	Call re-establishment, network side	N/A
5.5.5.1	State alignment	N/A
5.5.6	Progress	N/A
5.5.7	DTMF protocol control procedure	N/A
5.5.7.1	Start DTMF request by the mobile station	N/A
5.5.7.2	Start DTMF response by the network	N/A
5.5.7.3	Stop DTMF request by the mobile station	N/A
5.5.7.4	Stop DTMF response by the network	N/A
5.5.7.5	Sequencing of subsequent start DTMF requests by the mobile station	N/A
6.1.1	General	See annex I
6.1.3.1.1	Successful PDP context activation initiated by the mobile station	See annex I
6.1.3.2.1	Successful Secondary PDP Context Activation Procedure Initiated by the MS	See annex I
6.1.3.3.1	Network initiated PDP Context Modification	See annex I
6.1.3.4.1	PDP context deactivation initiated by the MS	See annex I
6.1.3.4.2	PDP context deactivation initiated by the network	See annex I
8.1	General	See annex I
8.3.1	Call control	N/A
8.4	Unknown or unforeseen message type	See annex I
8.5	Non-semantic mandatory information element errors	See annex I
8.5.3	Call control	N/A
8.7.2	Conditional IE errors	See annex I
8.8	Messages with semantically incorrect contents	See annex I
9	Message functional definitions and contents	See annex I
9.2.2	Authentication request	See annex I
9.2.2.1	Authentication Parameter AUTN	N/A
9.2.3	Authentication response	See annex I
9.2.3.2	Authentication Response Parameter (extension)	N/A
9.2.9	CM service request	See annex I
9.2.9.2	Priority	N/A
9.2.15	Location updating request	See annex I
9.2.15.3	Mobile Station Classmark for UMTS	N/A
9.3	Messages for circuit-switched call control	N/A
9.3.1	Alerting	N/A
9.3.1.1	Alerting (network to mobile station direction)	N/A
9.3.1.1.1	Facility	N/A
9.3.1.1.2	Progress indicator	N/A
9.3.1.1.3	User-user	N/A
9.3.1.2	Alerting (mobile station to network direction)	N/A
9.3.1.2.1	Facility	N/A
9.3.1.2.2	User-user	N/A
9.3.1.2.3	SS version	N/A
9.3.2	Call confirmed	N/A
9.3.2.1	Repeat indicator	N/A
9.3.2.2	Bearer capability 1 and bearer capability 2	N/A
9.3.2.3	Cause	N/A
9.3.2.4	CC Capabilities	N/A
9.3.2.5	Stream Identifier	N/A

Clause	Name	Status
9.3.3	Call proceeding	N/A
9.3.3.1	Repeat indicator	N/A
9.3.3.2	Bearer capability 1 and bearer capability 2	N/A
9.3.3.3	Facility	N/A
9.3.3.4	Progress Indicator	N/A
9.3.3.5	Priority granted	N/A
9.3.3.6	Network Call control Capabilities	N/A
9.3.4	Congestion control	N/A
9.3.4.1	Cause	N/A
9.3.5	Connect	N/A
9.3.5.1	Connect (network to mobile station direction)	N/A
9.3.5.1.1	Facility	N/A
9.3.5.1.2	Progress indicator	N/A
9.3.5.1.3	User-user	N/A
9.3.5.2	Connect (mobile station to network direction)	N/A
9.3.5.2.1	Facility	N/A
9.3.5.2.2	User-user	N/A
9.3.5.2.3	SS version	N/A
9.3.5.2.4	Stream Identifier	N/A
9.3.6	Connect acknowledge	N/A
9.3.7	Disconnect	N/A
9.3.7.1	Disconnect (network to mobile station direction)	N/A
9.3.7.1.1	Facility	N/A
9.3.7.1.2	Progress indicator	N/A
9.3.7.1.3	User-user	N/A
9.3.7.1.4	Allowed actions \$(CCBS)\$	N/A
9.3.7.2	Disconnect (mobile station to network direction)	N/A
9.3.7.2.1	Facility	N/A
9.3.7.2.2	User-user	N/A
9.3.7.2.3	SS version	N/A
9.3.8	Emergency setup	N/A
9.3.8.1	Bearer capability	N/A
9.3.8.2	Stream Identifier	N/A
9.3.9	Facility	N/A
9.3.9.1	Facility (network to mobile station direction)	N/A
9.3.9.2	Facility (mobile station to network direction)	N/A
9.3.9.2.1	SS version	N/A
9.3.10	Hold	N/A
9.3.11	Hold Acknowledge	N/A
9.3.12	Hold Reject	N/A
9.3.13	Modify	N/A
9.3.13.1	Low layer compatibility	N/A
9.3.13.2	High layer compatibility	N/A
9.3.13.3	Reverse call setup direction	N/A
9.3.13.4	Immediate modification indicator	N/A
9.3.14	Modify complete	N/A
9.3.14.1	Low layer compatibility	N/A
9.3.14.2	High layer compatibility	N/A
9.3.14.3	Reverse call setup direction	N/A
9.3.15	Modify reject	N/A
9.3.15.1	Low layer compatibility	N/A
9.3.15.2	High layer compatibility	N/A
9.3.16	Notify	N/A
9.3.17	Progress	N/A
9.3.17.1	User-user	N/A
9.3.17a	CC-Establishment \$(CCBS)\$	N/A
9.3.17a.1	Void	N/A
9.3.17a.2	Setup container	N/A
9.3.17b	CC-Establishment confirmed \$(CCBS)\$	N/A
9.3.17b.1	Repeat indicator	N/A
9.3.17b.2	Bearer capability 1 and bearer capability 2	N/A
9.3.17b.3	Cause	N/A
9.3.18	Release	N/A
9.3.18.1	Release (network to mobile station direction)	N/A

Clause	Name	Status
9.3.18.1.1	Cause	N/A
9.3.18.1.2	Second cause	N/A
9.3.18.1.3	Facility	N/A
9.3.18.1.4	User-user	N/A
9.3.18.2	Release (mobile station to network direction)	N/A
9.3.18.2.1	Cause	N/A
9.3.18.2.2	Second cause	N/A
9.3.18.2.3	Facility	N/A
9.3.18.2.4	User-user	N/A
9.3.18.2.5	SS version	N/A
9.3.18a	Recall \$(CCBS)\$	N/A
9.3.18a.1	Recall Type	N/A
9.3.18a.2	Facility	N/A
9.3.19	Release complete	N/A
9.3.19.1	Release complete (network to mobile station direction)	N/A
9.3.19.1.1	Cause	N/A
9.3.19.1.2	Facility	N/A
9.3.19.1.3	User-user	N/A
9.3.19.2	Release complete (mobile station to network direction)	N/A
9.3.19.2.1	Cause	N/A
9.3.19.2.2	Facility	N/A
9.3.19.2.3	User-user	N/A
9.3.19.2.4	SS version.	N/A
9.3.20	Retrieve	N/A
9.3.21	Retrieve Acknowledge	N/A
9.3.22	Retrieve Reject	N/A
9.3.23	Setup	N/A
9.3.23.1	Setup (mobile terminated call establishment)	N/A
9.3.23.1.1	BC repeat indicator	N/A
9.3.23.1.2	Bearer capability 1 and bearer capability 2	N/A
9.3.23.1.3	Facility	N/A
9.3.23.1.4	Progress indicator	N/A
9.3.23.1.4a	Called party BCD number	N/A
9.3.23.1.5	Called party subaddress	N/A
9.3.23.1.6	LLC repeat indicator	N/A
9.3.23.1.7	Low layer compatibility I	N/A
9.3.23.1.8	Low layer compatibility II	N/A
9.3.23.1.9	HLC repeat indicator	N/A
9.3.23.1.10	High layer compatibility i	N/A
9.3.23.1.11	High layer compatibility ii	N/A
9.3.23.1.12	User-user	N/A
9.3.23.1.13	Redirecting party BCD number	N/A
9.3.23.1.14	Redirecting party subaddress	N/A
9.3.23.1.15	Priority	N/A
9.3.23.1.16	Alert \$(Network Indication of Alerting in the MS)\$	N/A
9.3.23.1.17	Network Call control Capabilities	N/A
9.3.23.1.18	Cause of No CLI	N/A
9.3.23.2	Setup (mobile originating call establishment)	N/A
9.3.23.2.1	BC repeat indicator	N/A
9.3.23.2.2	Facility	N/A
9.3.23.2.3	LLC repeat indicator	N/A
9.3.23.2.4	Low layer compatibility I	N/A
9.3.23.2.5	Low layer compatibility II	N/A
9.3.23.2.6	HLC repeat indicator	N/A
9.3.23.2.7	High layer compatibility i	N/A
9.3.23.2.8	High layer compatibility ii	N/A
9.3.23.2.9	User-user	N/A
9.3.23.2.10	SS version	N/A
9.3.23.2.11	CLIR suppression	N/A
9.3.23.2.12	CLIR invocation	N/A
9.3.23.2.13	CC Capabilities	N/A
9.3.23.2.14	Stream Identifier	N/A
9.3.23.2.15	Bearer capability 1 and bearer capability 2	N/A
9.3.23a	Start CC \$(CCBS)\$	N/A

Clause	Name	Status
9.3.23a.1	CC Capabilities	N/A
9.3.24	Start DTMF	N/A
9.3.25	Start DTMF Acknowledge	N/A
9.3.25.1	Keypad facility	N/A
9.3.26	Start DTMF reject	N/A
9.3.27	Status	N/A
9.3.27.1	Auxiliary states	N/A
9.3.28	Status enquiry	N/A
9.3.29	Stop DTMF	N/A
9.3.30	Stop DTMF acknowledge	N/A
9.3.31	User information	N/A
9.3.31.1	User-user	N/A
9.3.31.2	More data	N/A
9.4.9	Authentication and ciphering request	See annex I
9.4.9.3	Authentication Parameter AUTN	N/A
9.4.10	Authentication and ciphering response	See annex I
9.4.10.1	Authentication Response Parameter	See annex I
9.4.10.3	Authentication Response Parameter (extension)	N/A
9.4.14.5	P-TMSI (UMTS only)	N/A
9.4.20	Service Request (UMTS only)	N/A
9.4.20.1	Void	N/A
9.4.21	Service Accept (UMTS only)	N/A
9.4.22	Service Reject (UMTS only)	N/A
10.1	Overview	See annex I
10.3.2	Transaction identifier	See annex I
10.4	Message Type	See annex I
10.5	Other information elements	See annex I
10.5.1.4	Mobile Identity	See annex I
10.5.1.6	Mobile Station Classmark 2	See annex I
10.5.1.7	Mobile Station Classmark 3	See annex I
10.5.1.9	Descriptive group or broadcast call reference	N/A
10.5.1.10	Group Cipher Key Number	N/A
10.5.1.12	Core Network System Information (UMTS only)	N/A
10.5.1.12.1	CN Common GSM-MAP N/AS system information	N/A
10.5.1.12.2	CS domain specific system information	N/A
10.5.1.12.3	PS domain specific system information	N/A
10.5.3.1.1	Authentication Parameter AUTN (UMTS authentication challenge only)	N/A
10.5.3.2	Authentication Response parameter	See annex I
10.5.3.2.1	Authentication Response Parameter (extension) (UMTS authentication challenge only)	N/A
10.5.3.2.2	Authentication Failure parameter (UMTS authentication challenge only)	N/A
10.5.3.3	CM service type	See annex I
10.5.4	Call control information elements	N/A
10.5.4.1	Extensions of codesets	N/A
10.5.4.2	Locking shift procedure	N/A
10.5.4.3	Non-locking shift procedure	N/A
10.5.4.4	Auxiliary states	N/A
10.5.4.5	Bearer capability	N/A
10.5.4.5.1	Static conditions for the bearer capability IE contents	N/A
10.5.4.5a	Call control Capabilities	N/A
10.5.4.6	Call state	N/A
10.5.4.7	Called party BCD number	N/A
10.5.4.8	Called party subaddress	N/A
10.5.4.9	Calling party BCD number	N/A
10.5.4.10	Calling party subaddress	N/A
10.5.4.11	Cause	N/A
10.5.4.11a	CLIR suppression	N/A
10.5.4.11b	CLIR invocation	N/A
10.5.4.12	Congestion level	N/A
10.5.4.13	Connected number	N/A
10.5.4.14	Connected subaddress	N/A
10.5.4.15	Facility	N/A
10.5.4.16	High layer compatibility	N/A
10.5.4.16.1	Static conditions for the high layer compatibility IE contents	N/A

Clause	Name	Status
10.5.4.17	Keypad facility	N/A
10.5.4.18	Low layer compatibility	N/A
10.5.4.19	More data	N/A
10.5.4.20	Notification indicator	N/A
10.5.4.21	Progress indicator	N/A
10.5.4.21a	Recall type \$(CCBS)\$	N/A
10.5.4.21b	Redirecting party BCD number	N/A
10.5.4.21c	Redirecting party subaddress	N/A
10.5.4.22	Repeat indicator	N/A
10.5.4.22a	Reverse call setup direction	N/A
10.5.4.22b	SETUP Container \$(CCBS)\$	N/A
10.5.4.23	Signal	N/A
10.5.4.24	SS Version Indicator	N/A
10.5.4.25	User-user	N/A
10.5.4.26	Alerting Pattern \$(NIA)\$	N/A
10.5.4.27	Allowed actions \$(CCBS)\$	N/A
10.5.4.28	Stream Identifier	N/A
10.5.4.29	Network Call control Capabilities	N/A
10.5.4.30	Cause of No CLI	N/A
10.5.4.31	Immediate modification indicator	N/A
10.5.5.12a	MS Radio Access capability	See annex I
11.2.2	Timers of GPRS mobility management	See annex I
11.3	Timers of circuit-switched call control	N/A
Annex A	Example of subaddress information element coding	N/A
Annex B	Compatibility checking	N/A
B.1	Introduction	N/A
B.2	Calling side compatibility checking	N/A
B.2.1	Compatibility checking of the CM SERVICE REQUEST message	N/A
B.2.2	Compatibility/Subscription checking of the SETUP message	N/A
B.3	Called side compatibility checking	N/A
B.3.1	Compatibility checking with addressing information	N/A
B.3.2	Network-to-MS compatibility checking	N/A
B.3.3	User-to-User compatibility checking	N/A
B.4	High layer compatibility checking	N/A
Annex C	Low layer information coding principles	N/A
C.1	Purpose	N/A
C.2	Principles	N/A
C.2.1	Definition of types of information	N/A
C.2.2	Examination by network	N/A
C.2.3	Location of type I information	N/A
C.2.4	Location of types II and III information	N/A
C.2.5	Relationship between bearer capability and low layer compatibility information elements	N/A
Annex D	Examples of bearer capability information element coding	N/A
D.1	Coding for speech for a full rate support only mobile station	N/A
D.1.1	Mobile station to network direction	N/A
D.1.2	Network to mobile station direction	N/A
D.2	An example of a coding for modem access with V22-bis, 2,4 kbit/s, 8 bit no parity	N/A
D.2.1	Mobile station to network direction, data compression allowed	N/A
D.2.2	Network to mobile station direction, data compression possible	N/A
D.3	An example of a coding for group 3 facsimile (9,6 kbit/s, transparent)	N/A
D.3.1	Mobile station to network direction	N/A
D.3.2	Network to mobile station direction	N/A
Annex E	Comparison between call control procedures specified in 3GPP TS 24.008 and ITU-T Recommendation Q.931	N/A
Annex G		N/A
G.1	Causes related to MS identification	N/A
G.2	Cause related to subscription options	N/A
G.3	Causes related to PLMN specific network failures and congestion/Authentication Failures	N/A
G.4	Causes related to nature of request	N/A
G.5	Causes related to invalid messages	N/A
G.6	Additional cause codes for GMM	N/A

Clause	Name	Status
Annex H	UMTS specific cause values for call control	N/A
H.1	Normal class	N/A
H.1.1	Cause No. 1 "unassigned (unallocated) number"	N/A
H.1.2	Cause No. 3 "no route to destination"	N/A
H.1.3	Cause No. 6 "channel unacceptable"	N/A
H.1.4	Cause No. 8 "operator determined barring"	N/A
H.1.5	Cause No.16 "normal call clearing"	N/A
H.1.6	Cause No.17 "user busy"	N/A
H.1.7	Cause No. 18 "no user responding"	N/A
H.1.8	Cause No. 19 "user alerting, no answer"	N/A
H.1.9	Cause No. 21 "call rejected"	N/A
H.1.10	Cause No. 22 "number changed"	N/A
H.1.11	Cause No. 25 "pre-emption"	N/A
H.1.12	Cause No. 26 "non-selected user clearing"	N/A
H.1.13	Cause No. 27 "destination out of order"	N/A
H.1.14	Cause No. 28 "invalid number format (incomplete number)"	N/A
H.1.15	Cause No. 29 "facility rejected"	N/A
H.1.16	Cause No. 30 "response to STATUS ENQUIRY"	N/A
H.1.17	Cause No. 31 "normal, unspecified"	N/A
H.2	Resource unavailable class	N/A
H.2.1	Cause No. 34 "no circuit/channel available"	N/A
H.2.2	Cause No. 38 "network out of order"	N/A
H.2.3	Cause No. 41 "temporary failure"	N/A
H.2.4	Cause No. 42 "switching equipment congestion"	N/A
H.2.5	Cause No. 43 "access information discarded"	N/A
H.2.6	Cause No. 44 "requested circuit/channel not available"	N/A
H.2.7	Cause No. 47 "resource unavailable, unspecified"	N/A
H.3	Service or option not available class	N/A
H.3.1	Cause No. 49 "quality of service unavailable"	N/A
H.3.2	Cause No. 50 "Requested facility not subscribed"	N/A
H.3.3	Cause No. 55 "Incoming calls barred within the CUG"	N/A
H.3.4	Cause No. 57 "bearer capability not authorized"	N/A
H.3.5	Cause No. 58 "bearer capability not presently available"	N/A
H.3.6	Cause No. 63 "service or option not available, unspecified"	N/A
H.3.7	Cause No. 68 "ACM equal to or greater than ACMmax"	N/A
H.4	Service or option not implemented class	N/A
H.4.1	Cause No. 65 "bearer service not implemented"	N/A
H.4.2	Cause No. 69 "Requested facility not implemented"	N/A
H.4.3	Cause No. 70 "only restricted digital information bearer capability is available"	N/A
H.4.4	Cause No. 79 "service or option not implemented, unspecified"	N/A
H.5	Invalid message (e.g. parameter out of range) class	N/A
H.5.1	Cause No. 81 "invalid transaction identifier value"	N/A
H.5.2	Cause No. 87 "user not member of CUG"	N/A
H.5.3	Cause No. 88 "incompatible destination"	N/A
H.5.4	Cause No. 91 "invalid transit network selection"	N/A
H.5.5	Cause No. 95 "semantically incorrect message"	N/A
H.6	Protocol error (e.g. unknown message) class	N/A
H.6.1	Cause No. 96 "invalid mandatory information"	N/A
H.6.2	Cause No. 97 "message type non-existent or not implemented"	N/A
H.6.3	Cause No. 98 "message type not compatible with protocol state"	N/A
H.6.4	Cause No. 99 "information element non-existent or not implemented"	N/A
H.6.5	Cause No. 100 "conditional IE error"	N/A
H.6.6	Cause No. 101 "message not compatible with protocol state"	N/A
H.6.7	Cause No. 102 "recovery on timer expiry"	N/A
H.6.8	Cause No. 111 "protocol error, unspecified"	N/A
H.7	Interworking class	N/A
H.7.1	Cause No. 127 "interworking, unspecified"	N/A
K.4	Call control information elements.	N/A
Annex M	Additional Requirements for backward compatibility with PCS 1900 for N/A revision 0 ME	N/A

## 4.26 Applicability of TS 24.011

TS 24.011 is applicable, except as described in table 26 and annex J.

**Table 26: Applicability of clauses from TS 24.011 to TAPS**

Clause	Name	Status
1.2	Abbreviations	See annex J
2	Overview of Short Message Service (SMS) support	See annex J
2.1	Protocols and protocol architecture	See annex J
2.2	Use of channels (A/Gb mode only)	N/A
2.3	Layer 2 SAPI 3 handling for circuit switched in A/Gb mode	N/A
2.4	Layer 2 (LLC) GPRS support (A/Gb mode only)	See annex J
2.5	GSMS entity in lu mode	N/A
3.2	Service provided by the CM-sublayer	See annex J
3.2.1.1	MNSMS-ABORT-REQuest	See annex J
3.2.1.4	MNSMS-ESTablish-REQuest	See annex J
3.2.1.6	MNSMS-ERROR-INDication	See annex J
3.2.1.7	MNSMS-RELease-REQuest	See annex J
3.2.2.4	MNSMS-ESTablish-REQuest	See annex J
3.2.2.6	MNSMS-ERROR-INDication	See annex J
3.2.2.7	MNSMS-RELease-REQuest	See annex J
5.1	General	See annex J
5.2.1	SMC-CS states at the MS side of the radio interface	N/A
5.2.1.1	Mobile Originating Case	N/A
5.2.1.1.1	MO-Idle (State 0)	N/A
5.2.1.1.2	MO-MM-connection pending (State 1)	N/A
5.2.1.1.3	MO-Wait for CP-ACK (State 2)	N/A
5.2.1.1.4	MO-MM-connection established (State 3)	N/A
5.2.1.2	Mobile Terminating case	N/A
5.2.1.2.1	MT-Idle (State 0)	N/A
5.2.1.2.2	MT-Wait for CP-ACK (State 2)	N/A
5.2.1.2.3	MT-MM-connection established (State 3)	N/A
5.2.2.1.2	MO-GMM-connection pending (State 1) (lu mode only)	N/A
5.2.3	SMC-CS states at the network side of the radio interface	N/A
5.2.3.1	Mobile Originating Case	N/A
5.2.3.1.1	MO-Idle (State 0)	N/A
5.2.3.1.2	MO-Wait for CP-ACK (State 2)	N/A
5.2.3.1.3	MO-MM-connection established (State 3)	N/A
5.2.3.2	Mobile Terminating Case	N/A
5.2.3.2.1	MT-Idle (State 0)	N/A
5.2.3.2.2	MT-MM-connection pending (State 1)	N/A
5.2.3.2.3	MT-Wait for CP-ACK (State 2)	N/A
5.2.3.2.4	MT-MM-connection established (State 3)	N/A
5.3.1	MM-connection establishment for circuit switched service	N/A
5.3.2.1	RPDU transfer for circuit switched service	N/A
5.3.3	Release of MM and CM connections	N/A
5.3.4	Abnormal cases	See annex J
5.4	Concatenating short message or notification transfers	N/A
9.2	CP Error Handling	See annex J
Annex A	Arrow diagrams	See annex J
B.1	Introduction	See annex J
Annex F	LAPDm SAPI 3 handling for short message service	N/A



## 4.27 Applicability of TS 27.007

TS 27.007 is applicable, except as described in table 27.

**Table 27: Applicability of clauses from TS 27.007 to TAPS**

Clause	Name	Status
6	Call control commands and methods	N/A
6.1	Select type of address +CSTA	N/A
6.2	ITU-T V.25ter dial command D	N/A
6.3	Direct dialling from phonebooks	N/A
6.4	Call mode +CMOD	N/A
6.5	Hangup call +CHUP	N/A
6.6	Alternating mode call control method	N/A
6.7	Select bearer service type +CBST	N/A
6.8	Radio link protocol +CRLP	N/A
6.9	Service reporting control +CR	N/A
6.10	Extended error report +CEER	N/A
6.11	Cellular result codes +CRC	N/A
6.12	HSCSD device parameters +CHSD	N/A
6.13	HSCSD transparent call configuration +CHST	N/A
6.14	HSCSD non-transparent call configuration +CHSN	N/A
6.15	HSCSD current call parameters +CHSC	N/A
6.16	HSCSD parameters report +CHSR	N/A
6.17	HSCSD automatic user initiated upgrading + CHSU	N/A
6.18	HSCSD non-transparent asymmetry configuration +CHSA	N/A
6.19	Single numbering scheme +CSNS	N/A
6.20	Voice Hangup Control +CVHU	N/A
6.21	V.120 rate adaption protocol +CV120	N/A
6.22	Settings date format +CSDF	N/A
6.23	Silence Command +CSIL	N/A
6.24	Settings time format +CSTF	N/A
6.25	ITU-T V.25ter call control commands	N/A
6.26	ITU-T V.25ter data compression commands	N/A
6.27	Informative examples	N/A
7.6	Calling line identification presentation +CLIP	N/A
7.7	Calling line identification restriction +CLIR	N/A
7.8	Connected line identification presentation +COLP	N/A
7.9	Called line identification presentation +CDIP	N/A
7.10	Closed user group +CCUG	N/A
7.11	Call forwarding number and conditions +CCFC	N/A
7.12	Call waiting +CCWA	N/A
7.13	Call related supplementary services +CHLD	N/A
7.14	Call deflection +CTFR	N/A
7.15	Unstructured supplementary service data +CUSD	N/A
7.16	Advice of Charge +CAOC	N/A
7.17	Supplementary service notifications +CSSN	N/A
7.18	List current calls +CLCC	N/A
7.21	eMLPP Priority Registration and Interrogation +CAEMLPP	N/A
8.20	Alert sound mode +CALM	N/A
8.21	Ringer sound level +CRSL	N/A
8.22	Vibrator mode +CVIB	N/A
8.23	Loudspeaker volume level +CLVL	N/A
8.24	Mute control +CMUT	N/A
8.25	Accumulated call meter +CACM	N/A
8.26	Accumulated call meter maximum +CAMM	N/A
8.27	Price per unit and currency table +CPUC	N/A
8.28	Call Meter maximum event +CCWE	N/A
8.33	Set Voice Mail Number +CSVM	N/A
8.34	Ring Melody Playback +CRMP	N/A
9.2.3	VBS/VGCS and eMLPP -related errors	N/A
10.1.6	3G Quality of Service Profile (Requested) +CGEQREQ	N/A
10.1.7	3G Quality of Service Profile (Minimum acceptable) +CGEQMIN	N/A
10.1.8	3G Quality of Service Profile (Negotiated) +CGEQNEG	N/A
11	Commands for VGCS and VBS	N/A

Clause	Name	Status
11.1	Commands specific to MTs supporting the VGCS and VBS	N/A
11.1.1	Accept an incoming Voice Group or Voice Broadcast Call +CAJOIN	N/A
11.1.2	Reject an incoming Voice Group or Voice Broadcast Call +CAREJ	N/A
11.1.3	Leave an ongoing Voice Group or Voice Broadcast Call +CAHLD	N/A
11.1.4	Talker Access for Voice Group Call +CAPTT	N/A
11.1.5	Voice Group Call Uplink Status Presentation +CAULEV	N/A
11.1.6	List current Voice Group and Voice Broadcast Calls +CALCC	N/A
11.1.7	Voice Group or Voice Broadcast Call State Attribute Presentation +CACSP	N/A
11.1.8	NCH Support Indication +CANCHEV	N/A
11.2	Modem compatibility commands	N/A
11.2.1	Request VGCS or VBS service 'D'	N/A
11.2.2	Termination of an Voice Group or Voice Broadcast Call 'H'	N/A
11.3	Informative examples	N/A

## 4.28 Applicability of TS 29.002

TS 29.002 is applicable, except as described in table 28.

**Table 28: Applicability of clauses from TS 29.002 to TAPS**

Clause	Name	Status
10	Call handling services	N/A
10.1	MAP_SEND_ROUTING_INFORMATION service	N/A
10.1.1	Definition	N/A
10.1.2	Service primitives	N/A
10.1.3	Parameter use	N/A
10.2	MAP_PROVIDE_ROAMING_NUMBER service	N/A
10.2.1	Definition	N/A
10.2.2	Service primitives	N/A
10.2.3	Parameter use	N/A
10.3	MAP_RESUME_CALL_HANDLING service	N/A
10.3.1	Definition	N/A
10.3.2	Service primitives	N/A
10.3.3	Parameter use	N/A
10.4	MAP_PREPARE_GROUP_CALL service	N/A
10.4.1	Definition	N/A
10.4.2	Service primitives	N/A
10.4.3	Parameter definitions and use	N/A
10.5	MAP_PROCESS_GROUP_CALL_SIGN/ALLING service	N/A
10.5.1	Definitions	N/A
10.5.2	Service primitives	N/A
10.5.3	Parameter definitions and use	N/A
10.6	MAP_FORWARD_GROUP_CALL_SIGN/ALLING service	N/A
10.6.1	Definitions	N/A
10.6.2	Service primitives	N/A
10.6.3	Parameter definitions and use	N/A
10.7	MAP_SEND_GROUP_CALL_END_SIGN/AL service	N/A
10.7.1	Definitions	N/A
10.7.2	Service primitives	N/A
10.7.3	Parameter definitions and use	N/A
10.8	MAP_Provide_SIWFS_Number	N/A
10.8.1	Definition	N/A
10.8.2	Service primitive	N/A
10.8.3	Parameter use	N/A
10.9	MAP_SIWFS_Signalling_Modify	N/A
10.9.1	Definition	N/A
10.9.2	Service primitive	N/A
10.9.3	Parameter use	N/A
10.10	MAP_SET_REPORTING_STATE service	N/A
10.10.1	Definition	N/A
10.10.2	Service primitives	N/A
10.10.3	Parameter use	N/A

Clause	Name	Status
10.11	MAP_STATUS_REPORT service	N/A
10.11.1	Definition	N/A
10.11.2	Service primitives	N/A
10.11.3	Parameter use	N/A
10.12	MAP_REMOTE_USER_FREE service	N/A
10.12.1	Definition	N/A
10.12.2	Service primitives	N/A
10.12.3	Parameter use	N/A
10.13	MAP_IST_ALERT service	N/A
10.13.1	Definition	N/A
10.13.2	Service primitives	N/A
10.13.3	Parameter use	N/A
10.14	MAP_IST_COMMAND service	N/A
10.14.1	Definition	N/A
10.14.2	Service primitives	N/A
10.14.3	Parameter use	N/A
11	Supplementary services related services	N/A
11.1	MAP_REGISTER_SS service	N/A
11.1.1	Definition	N/A
11.1.2	Service primitives	N/A
11.1.3	Parameter use	N/A
11.2	MAP_ERASE_SS service	N/A
11.2.1	Definition	N/A
11.2.2	Service primitives	N/A
11.2.3	Parameter use	N/A
11.3	MAP_ACTIVATE_SS service	N/A
11.3.1	Definition	N/A
11.3.2	Service primitives	N/A
11.3.3	Parameter use	N/A
11.4	MAP_DEACTIVATE_SS service	N/A
11.4.1	Definitions	N/A
11.4.2	Service primitives	N/A
11.4.3	Parameter use	N/A
11.5	MAP_INTERROGATE_SS service	N/A
11.5.1	Definitions	N/A
11.5.2	Service primitives	N/A
11.5.3	Parameter use	N/A
11.6	MAP_INVOKE_SS service	N/A
11.6.1	Definitions	N/A
11.6.2	Service primitives	N/A
11.6.3	Parameter use	N/A
11.7	MAP_REGISTER_PASSWORD service	N/A
11.7.1	Definitions	N/A
11.7.2	Service primitives	N/A
11.7.3	Parameter use	N/A
11.8	MAP_GET_PASSWORD service	N/A
11.8.1	Definitions	N/A
11.8.2	Service primitives	N/A
11.8.3	Parameter use	N/A
11.9	MAP_PROCESS_UNSTRUCTURED_SS_REQUEST service	N/A
11.9.1	Definitions	N/A
11.9.2	Service primitives	N/A
11.9.3	Parameter use	N/A
11.10	MAP_UNSTRUCTURED_SS_REQUEST service	N/A
11.10.1	Definitions	N/A
11.10.2	Service primitives	N/A
11.10.3	Parameter use	N/A
11.11	MAP_UNSTRUCTURED_SS_NOTIFY service	N/A
11.11.1	Definitions	N/A
11.11.2	Service primitives	N/A
11.11.3	Parameter use	N/A
11.12	MAP_SS_INVOCATION_NOTIFY	N/A
11.12.1	Definition	N/A
11.12.2	Service primitives	N/A

Clause	Name	Status
11.12.3	Parameter use	N/A
11.13	MAP_REGISTER_CC_ENTRY service	N/A
11.13.1	Definition	N/A
11.13.2	Service primitives	N/A
11.13.3	Parameter use	N/A
11.14	MAP_ERASE_CC_ENTRY service	N/A
11.14.1	Definition	N/A
11.14.2	Service primitives	N/A
11.14.3	Parameter use	N/A
21	Call handling procedures	N/A
21.1	General	N/A
21.2	Retrieval of routing information	N/A
21.2.1	General	N/A
21.2.2	Process in the GMSC	N/A
21.2.3	Procedures in the HLR	N/A
21.2.4	Process in the VLR to provide a roaming number	N/A
21.2.5	Process in the VLR to restore subscriber data	N/A
21.2.6	Process in the VLR to provide subscriber information	N/A
21.2.7	Process in the HLR for Any Time Interrogation	N/A
21.2.8	Process in the GMLC for Any Time Interrogation	N/A
21.3	Transfer of call handling	N/A
21.3.1	General	N/A
21.3.2	Process in the VMSC	N/A
21.3.3	Process in the GMSC	N/A
21.4	Inter MSC Group Call Procedures	N/A
21.4.1	General	N/A
21.4.2	Process in the Anchor MSC	N/A
21.4.3	Process in the Relay MSC	N/A
21.5	Allocation and modifications of resources in an SIWFS	N/A
21.5.1	General	N/A
21.5.2	Process in the VMSC	N/A
21.5.3	Process in the SIWFS	N/A
21.6	Setting of Reporting State	N/A
21.6.1	General	N/A
21.6.2	Process in the HLR for Set Reporting State stand-alone	N/A
21.6.3	Reporting co-ordinator process in the VLR	N/A
21.6.4	Process in the VLR to set the reporting state	N/A
21.7	Status Reporting	N/A
21.7.1	General	N/A
21.7.2	Process in the VLR for Status Reporting	N/A
21.7.3	Process in the HLR for Status Reporting	N/A
21.8	Remote User Free	N/A
21.8.1	General	N/A
21.8.2	Process in the HLR for Remote User Free	N/A
21.8.3	Process in the VLR for Remote User Free	N/A
21.9	IST Alert	N/A
21.9.1	General	N/A
21.9.2	Procedure in the MSC	N/A
21.9.3	Procedure in the HLR	N/A
21.10	IST Command	N/A
21.10.1	General	N/A
21.10.2	Procedure in the HLR	N/A
21.10.3	Procedure in the MSC	N/A
22	Supplementary services procedures	N/A
22.1	Functional supplementary service processes	N/A
22.1.1	Functional supplementary service process co-ordinator for MSC	N/A
22.1.2	Functional supplementary service process co-ordinator for VLR	N/A
22.1.3	Functional supplementary service process co-ordinator for HLR	N/A
22.1.4	Call completion supplementary service process co-ordinator for HLR	N/A
22.2	Registration procedure	N/A
22.2.1	General	N/A
22.2.2	Procedures in the MSC	N/A
22.2.3	Procedures in the VLR	N/A
22.2.4	Procedures in the HLR	N/A

Clause	Name	Status
22.3	Erasure procedure	N/A
22.3.1	General	N/A
22.3.2	Procedures in the MSC	N/A
22.3.3	Procedures in the VLR	N/A
22.3.4	Procedures in the HLR	N/A
22.4	Activation procedure	N/A
22.4.1	General	N/A
22.4.2	Procedures in the MSC	N/A
22.4.3	Procedures in the VLR	N/A
22.4.4	Procedures in the HLR	N/A
22.5	Deactivation procedure	N/A
22.5.1	General	N/A
22.5.2	Procedures in the MSC	N/A
22.5.3	Procedures in the VLR	N/A
22.5.4	Procedures in the HLR	N/A
22.6	Interrogation procedure	N/A
22.6.1	General	N/A
22.6.2	Procedures in the MSC	N/A
22.6.3	Procedures in the VLR	N/A
22.6.4	Procedures in the HLR	N/A
22.7	Invocation procedure	N/A
22.7.1	General	N/A
22.7.2	Procedures in the MSC	N/A
22.7.3	Procedures in the VLR	N/A
22.8	Password registration procedure	N/A
22.8.1	General	N/A
22.8.2	Procedures in the MSC	N/A
22.8.3	Procedures in the VLR	N/A
22.8.4	Procedures in the HLR	N/A
22.9	Mobile Initiated USSD procedure	N/A
22.9.1	General	N/A
22.9.2	Procedures in the MSC	N/A
22.9.3	Procedures in the VLR	N/A
22.9.4	Procedures in the HLR	N/A
22.9.5	Procedures in the gsmSCF/secondary HLR	N/A
22.10	Network initiated USSD procedure	N/A
22.10.1	General	N/A
22.10.2	Procedure in the MSC	N/A
22.10.3	Procedure in the VLR	N/A
22.10.4	Procedure in the HLR	N/A
22.10.5	Procedure in the gsmSCF and secondary HLR	N/A
22.11	Common macros for clause 22	N/A
22.11.1	SS Password handling macros	N/A
22.11.2	SS Error handling macros	N/A
22.12	Supplementary Service Invocation Notification procedure	N/A
22.12.1	General	N/A
22.12.2	Procedures in the MSC	N/A
22.12.3	Procedures in the gsmSCF	N/A
22.13	Activation of a CCBS request	N/A
22.13.1	General	N/A
22.13.2	Procedure in the VLR	N/A
22.13.3	Procedure in the HLR	N/A
22.14	Deactivation of a CCBS request	N/A
22.14.1	General	N/A
22.14.2	Procedure in the VLR	N/A
22.14.3	Procedure in the HLR	N/A

## 4.29 Applicability of TS 29.010

TS 29.010 is applicable, except as described in table 29.

**Table 29: Applicability of clauses from TS 29.010 to TAPS**

Clause	Name	Status
4.2	Outgoing call set-up (MS originating call)	N/A
4.3	Incoming call set-up (MS terminating call)	N/A
4.4	Cipher mode setting	N/A
4.6	Inter-MSC Handover (UMTS to GSM)	N/A
4.6.1	Basic Inter-MSC Handover	N/A
4.6.2	Subsequent Inter-MSC Handover from 3G-MSC-B back to MSC-A	N/A
4.6.3	Subsequent Inter-MSC Handover to third MSC	N/A
4.6.4	BSSAP Messages transfer on E-Interface	N/A
4.6.5	Cause Code Mapping	N/A
4.7	Inter-MSC Handover (GSM to UMTS)	N/A
4.7.1	Basic Inter-MSC Handover	N/A
4.7.2	Subsequent Inter-MSC Handover from MSC-B back to 3G_MSC-A	N/A
4.7.3	Subsequent Inter-MSC Handover to third MSC	N/A
4.7.4	BSSAP Messages transfer on E-Interface	N/A
4.7.4.1	Assignment	N/A
4.7.4.2	Cipher Mode Control	N/A
4.7.4.3	Location Reporting Control	N/A
4.7.5	Processing in 3G_MSC-B, and information transfer on E-interface	N/A
4.7.5.1	Encryption Information	N/A
4.7.5.2	Channel Type	N/A
4.7.5.3	Classmark	N/A
4.7.5.4	Priority	N/A
4.7.5.5	MSC-Invoke Trace Information Elements	N/A
4.7.6	Cause Code Mapping	N/A

## 4.30 Applicability of TS 29.078

TS 29.078 is applicable, except as described in table 30.

**Table 30: Applicability of clauses from TS 29.078 to TAPS**

Clause	Name	Status
6	Circuit Switched Call Control	N/A
6.1	gsmSSF/CCF - gsmSCF Interface	N/A
6.1.1	Operations and arguments	N/A
6.1.2	gsmSSF/gsmSCF packages, contracts and ACs	N/A
6.1.2.1	gsmSSF/gsmSCF ASN.1 module	N/A
6.2	gsmSCF/gsmSRF interface	N/A
6.2.1	gsmSCF/gsmSRF operations and arguments	N/A
6.2.2	gsmSRF/gsmSCF contracts, packages and ACs	N/A
6.2.2.1	gsmSRF/gsmSCF ASN.1 modules	N/A

## Annex A (normative): Modification to GSM 04.18

This annex details the modified clauses of GSM 04.18 which are applicable to TAPS.

All references to other GSM standards and specifications are to the standards as modified by the present document.

The following clauses have the same numbering as in GSM 04.18.

### 1.5 Use of logical channels

The logical control channels are defined in 3GPP TS 05.02. In the following those control channels are considered which carry signalling information or specific types of user packet information:

- i) Broadcast Control CHannel (BCCH): downlink only, used to broadcast Cell specific information;
- ii) Synchronization CHannel (SCH): downlink only, used to broadcast synchronization and BSS identification information;
- iii) Paging CHannel (PCH): downlink only, used to send page requests to Mobile Stations (MSs);
- iv) Random Access CHannel (RACH): uplink only, used to request a Dedicated Control CHannel;
- v) Access Grant CHannel (AGCH): downlink only, used to allocate a Dedicated Control CHannel;
- vi) Standalone Dedicated Control CHannel (SDCCH): bi-directional;
- vii) Fast Associated Control CHannel (FACCH): bi-directional, associated with a Traffic CHannel;
- viii) Slow Associated Control CHannel (SACCH): bi-directional, associated with a SDCCH or a Traffic CHannel;
- ix) Cell Broadcast CHannel (CBCH): downlink only used for general (not point to point) short message information;

Two service access points are defined on signalling layer 2 which are discriminated by their Service Access Point Identifiers (SAPI) (see EN 300 938):

- i) SAPI 0: supports the transfer of signalling information including user-user information;
- ii) SAPI 3: supports the transfer of user short messages.

Layer 3 selects the service access point, the logical control channel and the mode of operation of layer 2 (acknowledged, unacknowledged or random access, see EN 300 937 and EN 300 938) as required for each individual message.

#### 1.6.1 List of procedures

The following procedures are specified in the present document:

- a) Clause 3 specifies elementary procedures for Radio Resource management:
  - system information broadcasting (clause 3.2.2)
  - RR connection establishment (clause 3.3)
    - entering the dedicated mode : immediate assignment procedure (clause 3.3.1.1)
    - paging procedure for RR connection establishment (clause 3.3.2)

- Procedures in dedicated mode (clause 3.4)
  - measurement report procedure (clause 3.4.1.2)
  - intracell change of channels (clause 3.4.3)
  - intercell change of channels (clause 3.4.4)
  - frequency redefinition procedure (clause 3.4.5)
  - ciphering mode setting procedure (clause 3.4.7)
  - additional channel assignment procedure (clause 3.4.8)
  - partial channel release procedure (clause 3.4.9)
- radio resources connection release (clause 3.4.13)
- application procedures (clause 3.4.21)
- RR procedures on CCCH related to temporary block flow establishment (clause 3.5)
  - packet paging procedure using CCCH (clause 3.5.1)
  - packet access procedure using CCCH (clause 3.5.2)
- packet downlink assignment procedure using CCCH (clause 3.5.3)
- RR procedures on DCCH related to temporary block flow establishment
  - Assignment to Packet Data Channel procedure (clause 3.4.19)
  - Network commanded cell reselection (clause 3.4.20)

Clause 8 specifies actions to be taken on various error conditions and also provides rules to ensure compatibility with future enhancements of the protocol.

## 1.7.2 General Packet Radio Service (GPRS)

The MS operation mode C applies for the present document.

### 2.1.2 Vocabulary

The following terms are used in the present document:

- **idle mode:** In this mode, the mobile station is not allocated any dedicated channel; it listens to the CCCH and the BCCH.
- **dedicated mode:** In this mode, the mobile station is allocated at least two dedicated channels, only one of them being a SACCH.
- **packet idle mode:** (only applicable for mobile stations supporting GPRS) In this mode, mobile station is not allocated any radio resource on a packet data physical channel; it listens to the PBCCH and PCCCH or, if those are not provided by the network, to the BCCH and the CCCH, see 3GPP TS 04.60.
- **packet transfer mode:** (only applicable for mobile stations supporting GPRS) In this mode, the mobile station is allocated radio resource on one or more packet data physical channels for the transfer of LLC PDUs.
- **main DCCH:** In Dedicated mode, only two channels are used as DCCH, one being a SACCH, the other being a SDCCH or a FACCH; the SDCCH or FACCH is called here "the main DCCH".
- A channel is **activated** if it can be used for transmission, in particular for signalling, at least with UI frames. On the SACCH, whenever activated, it must be ensured that a contiguous stream of layer 2 frames is sent.
- A TCH is **connected** if circuit mode user data can be transferred. A TCH cannot be connected if it is not activated. A TCH which is activated but not connected is used only for signalling, i.e. as a DCCH.



- The data link of SAPI 0 on the main DCCH is called the **main signalling link**. Any message specified to be sent on the main signalling link is sent in acknowledged mode except when otherwise specified.
- The term "**to establish**" a link is a short form for "**to establish the multiframe mode**" on that data link. It is possible to send UI frames on a data link even if it is not established as soon as the corresponding channel is activated. Except when otherwise indicated, a data link layer establishment is done without an information field.
- A **temporary block flow** (TBF) is a physical connection used by the two RR peer entities to support the uni-directional transfer of LLC PDUs on packet data physical channels, see 3GPP TS 04.60.
- **RLC/MAC block**: A RLC/MAC block is the protocol data unit exchanged between RLC/MAC entities, see 3GPP TS 04.60.
- A **GMM context** is established when a GPRS attach procedure is successfully completed.
- **Network operation mode**: The three different network operation modes I, II, and III are defined in 3GPP TS 23.060.

The network operation mode shall be indicated as system information. For proper operation, the network operation mode should be the same in each cell of one routing area.

- **GPRS MS operation mode**: The three different GPRS MS operation modes A, B, and C are defined in 3GPP TS 23.060.
- **Anonymous access** refers to limited service provisioning to an MS whose identity is unknown in the network.

## 3.1 Overview/General

### 3.1.1 General

Radio Resource management procedures include the functions related to the management of the common transmission resources, e.g. the physical channels and the data link connections on control channels.

The general purpose of Radio Resource procedures is to establish, maintain and release RR connections that allow a point-to-point dialogue between the network and a mobile station. This includes the cell selection/reselection and the handover procedures. Moreover, Radio Resource management procedures include the reception of the uni-directional BCCH and CCCH when no RR connection is established. This permits automatic cell selection/reselection.

If GPRS point-to-point services are supported, the radio resource management procedures includes functions related to the management of transmission resources on packet data physical channels. This includes the broadcast of system information to support a mobile station in packet idle and packet transfer modes, see also 3GPP TS 04.60.

NOTE 2: The procedures and the information content relating to the TCH/H + TCH/H configuration in RR messages is for further study.

#### 3.1.2.1 Idle mode

In idle mode no RR connection exists.

The RR procedures include (on the mobile station side) those for automatic cell selection/reselection. The RR entity indicates to upper layers the unavailability of a BCCH/CCCH and the cell change when decided by the RR entity. Upper layers are advised of the BCCH broadcast information when a new cell has been selected, or when a relevant part of this information changes.

For cell-reselection the BA (list) shall be used.

In Idle mode, upper layers can require the establishment of an RR connection.

### 3.1.2.2 Dedicated mode

In dedicated mode, the RR connection is a physical point-to-point bi-directional connection, and includes a SAPI 0 data link connection operating in multiframe mode on the main DCCH. If dedicated mode is established, RR procedures provide the following services:

- establishment/release of multiframe mode on data link layer connections other than SAPI 0, on the main DCCH or on the SACCH associated with the channel carrying the main signalling link;
- transfer of messages on any data link layer connection;
- indication of temporary unavailability of transmission (suspension, resuming);
- indication of loss of RR connection;
- automatic cell reselection and handover to maintain the RR connection;
- setting/change of the transmission mode on the physical channels, including change of type of channel, change of the coding/decoding/transcoding mode and setting of ciphering;
- allocation/release of an additional channel (for the TCH/H + TCH/H configuration);
- release of an RR connection.

### 3.1.2.6 Packet transfer mode

Only applicable for mobile stations supporting GPRS.

In packet transfer mode, the mobile station is allocated radio resource providing a temporary block flow on one or more packet data physical channels. The RR sublayer provides the following services, see also 3GPP TS 04.60:

- transfer of LLC PDUs in acknowledged mode;
- transfer of LLC PDUs in unacknowledged mode.

Cell reselection in packet idle and packet transfer modes is specified in 3GPP TS 05.08. The RR entity on the mobile station side indicates to the upper layers the availability of a cell and a cell change when decided by the RR sublayer. Upper layers are advised of system information broadcast in the cell when a new cell has been selected, or when a relevant part of this information changes.

### 3.1.4.3 Sequenced message transfer operation

Upper layer messages sent using the RR sub-layer transport service from the mobile station to the network can be duplicated by the data link layer in at least the following cases:

- a channel change of dedicated channels is required (assignment or handover procedure) and the last layer 2 frame has not been acknowledged by the peer data link layer before the mobile station leaves the old channel.

In this case, the mobile station does not know whether the network has received the message correctly. Therefore, the mobile station has to send the message again after the new dedicated channel is established (see EN 300 938).

The network must be able to detect the duplicated received message. Therefore, each concerned upper layer message must be marked with a send sequence number.

To allow for different termination points in the infrastructure of the messages of different PDs, the sequence numbering is specific to each PD. For historical reasons, an exception is that messages sent with the CC, SS and MM PDs share the same sequence numbering. In the following, the phrase **upper layer message flow** refers to a flow of messages sharing the same sequence numbering. The different upper layer flows are MM+CC+SS, GCC, BCC, RRLP and GTTP. The GMM, SM and SMS protocols do not use layer 3 sequence numbering.

### 3.1.4.3.1.1 Send state variable V(SD)

The RR (GSM case) sublayer of the mobile station shall have one associated send state variable V(SD) ("Send Duplicated") for each upper layer message flow. The send state variable denotes the sequence number of the next in sequence numbered message in the flow to be transmitted. The value of the corresponding send state variable shall be incremented by one with each numbered message transmission. When the RR or RRC connection starts with a core network of release '98 or earlier arithmetic operations on V(SD) are performed modulo 2. When the RR or RRC connection starts with a core network of Release '99 or later, arithmetic operations on V(SD) are performed modulo 4.

### 3.1.4.3.2.3 Termination

The sequenced message transfer operation is terminated by the RR connection release procedure.

## 3.1.6 Pre-emption

The datalink layer provides the capability to assign a priority to any message transferred in dedicated mode on SAPI 0 with multiframe operation. The available message priorities defined in EN 300 938 are "high", "normal" and "low". Messages assigned a "high" priority are enabled to pre-empt, in the data link layer, all preceding untransmitted and partially transmitted messages assigned a "low" priority that are using the same data link connection (same SAPI and logical channel). Messages or message portions that are pre-empted are discarded without notification to higher layers except that the first 2\*N201 octets of any partially transmitted message are not discarded. The following priority assignments are defined for those Radio Resource, Mobility Management and Connection Management messages that use SAPI 0.

**Table 3.1.6.1/3GPP TS 04.18: Priority Values of Layer 3 Messages**

Priority	Messages
Low	RR Application Information message
Normal	All MM messages All CM messages All GTTP messages All other RR messages using SAPI 0 not listed here
High	RR Channel Establishment: RR INITIALIZATION REQUEST IMMEDIATE ASSIGNMENT IMMEDIATE ASSIGNMENT EXTENDED IMMEDIATE ASSIGNMENT REJECT  RR Handover related ASSIGNMENT COMMAND ASSIGNMENT COMPLETE ASSIGNMENT FAILURE HANDOVER COMMAND HANDOVER COMPLETE HANDOVER FAILURE PHYSICAL INFORMATION RR-CELL CHANGE ORDER PDCH ASSIGNMENT COMMAND  RR Channel release CHANNEL RELEASE

Use of the pre-emption capability by layer 3 is not required in a BSS or MS that does not send any "low" priority message. In this case, all messages may be treated as having "normal" priority.

## 3.2.1 Mobile Station side

In idle mode, the MS listens to the BCCH and to the paging sub-channel for the paging group the MS belongs to in idle mode (see 3GPP TS 03.13); it measures the radio propagation for connection with other cells.

In packet idle and packet transfer modes (applicable only to a GPRS mobile station), the mobile station listens to either the PBCCH, if that is present in the cell, or BCCH. The requirements for the monitoring of system information is further specified in 3GPP TS 04.60. Moreover, the mobile station measures the radio propagation for connection with other cells.

In packet idle mode (applicable only to a GPRS mobile station), the mobile station listens to the paging sub-channels on the PCCCH or CCCH. Paging sub-channels are monitored according to the paging group determined for the mobile station and its current discontinuous reception (DRX) mode. The determination of paging group for the mobile station is defined in 3GPP TS 05.02. The DRX procedures are defined in 3GPP TS 04.60 and 3GPP TS 05.02.

Measurements are treated to assess the need of a cell change as specified in 3GPP TS 05.08. When the decision to change cells is made, the mobile station switches to the BCCH or PBCCH of the new cell. The broadcast information is then checked to verify the allowance to camp on this cell (see clause 3.2.2). Dependent on the mobile station type and configuration, the mobile station may be required to try to read further BCCH and PBCCH information. If allowed, the cell change is confirmed, and the broadcast information is then treated for Mobility Management actions (see clause 4). Similarly, physical contexts are updated (list of neighbouring cells frequencies, thresholds for some actions, etc. (see 3GPP TS 05.08 and clause 3.2.2)).

### 3.2.2.1 System information broadcasting

SYSTEM INFORMATION TYPE 2 to 4 messages, and optionally TYPE 1, 2bis, 2ter, 7, 8, 13, 16 and 17 and further types are regularly broadcast by the network on the BCCH. Based on this information the mobile station is able to decide whether and how it may gain access to the system via the current cell. The SYSTEM INFORMATION TYPE 2bis message shall be sent if and only if the EXT-IND bit in the Neighbour Cell Description IE in both the TYPE 2 and TYPE 2bis messages indicates that each IE only carries part of the BA. SYSTEM INFORMATION TYPE 2ter message shall be sent if and only if this is indicated in SYSTEM INFORMATION TYPE 3 message.

A GSM 900 mobile station which only supports the primary GSM band P-GSM 900 (see 3GPP TS 05.05) may consider the EXT-IND bit in the Neighbour Cell Description IE in the SYSTEM INFORMATION TYPE 2 message as a spare bit. If it does so it shall assume that the information element carries the complete BA and it shall ignore any SYSTEM INFORMATION TYPE 2bis and 2ter messages.

If the additional cell reselection parameters are broadcast then SYSTEM INFORMATION TYPE 3 message shall always contain these parameters. In addition to SYSTEM INFORMATION TYPE 3 at least either SYSTEM INFORMATION TYPE 4 or SYSTEM INFORMATION TYPE 7 and 8 messages shall contain these parameters too.

If additional SoLSA specific parameters are broadcast then SYSTEM INFORMATION TYPE 16 and 17 messages, shall always contain these parameters. In addition to SYSTEM INFORMATION TYPE 16 and 17 messages at least either SYSTEM INFORMATION TYPE 4 or SYSTEM INFORMATION TYPE 7 and 8 messages shall contain these SoLSA specific parameters too.

SYSTEM INFORMATION TYPE 19 messages shall be provided if COMPACT neighbour cells exist (see 3GPP TS 05.08). The presence of SI 19 messages shall be indicated in SI 9 message.

The support of GPRS shall be indicated in SYSTEM INFORMATION TYPE 3 message. In addition, the support of GPRS shall be indicated in either SYSTEM INFORMATION TYPE 4 or SYSTEM INFORMATION TYPE 7 and 8 messages. If GPRS is supported, SYSTEM INFORMATION TYPE 13 message shall be sent. SI 13 message shall not be sent if GPRS is not supported. Additional requirements for the broadcast of system information in a cell supporting GPRS are specified in 3GPP TS 04.60.

NOTE 1: The allowed scheduling of SYSTEM INFORMATION messages on the BCCH are specified in 3GPP TS 05.02.

NOTE 2: The network should take into account limitations of certain mobile stations to understand SYSTEM INFORMATION TYPE 2bis, TYPE 2ter, the EXT-IND bit in the Neighbour Cell Description, the indication of 2ter in SYSTEM INFORMATION TYPE 3 and formats used in the Neighbour Cell Description IE and Cell Channel Description IE used in SYSTEM INFORMATION messages, see this clause, clauses 10.5.2.1b and 10.5.2.22.

NOTE 3: The network should take into account the limitations of earlier versions of mobile equipment to understand the 3-digit MNC format of the location area identification, see clause 10.5.1.3.

The information broadcast may be grouped in the following classes:

- information giving unique identification of the current network, location area and cell;
- information used for candidate cell measurements for handover and cell selection procedures;
- information describing the current control channel structure;
- information controlling the random access channel utilization;
- information defining different options supported within the cell; and
- information about the length of the part of the message belonging to the phase 1 protocol.

The network may send to the mobile station BCCH scheduling information as specified below:

- 1) The BCCH scheduling information may be contained in the SYSTEM INFORMATION TYPE 9 messages. If so, SYSTEM INFORMATION TYPE 3 specifies where to find SYSTEM INFORMATION TYPE 9 messages carrying BCCH scheduling information.
- 2) If the mobile station has received BCCH scheduling information, it shall assume that this BCCH scheduling information is valid in the location area until new scheduling information is received. It may store the information in the ME and assume its validity after switch on in the same location area.
- 3) The network need not indicate the schedule of all SYSTEM INFORMATION messages in SYSTEM INFORMATION 9. For any System Information message, the MS shall monitor all blocks specified in 3GPP TS 05.02 for that System Information message and all blocks specified in the SYSTEM INFORMATION TYPE 9 message for that System Information message.
- 4) When the mobile station detects that the BCCH information is not scheduled as defined in the last received SI 9 message, it shall read the SYSTEM INFORMATION TYPE 3 message. If presence of BCCH scheduling information in SYSTEM INFORMATION TYPE 9 message is indicated, it shall try to read the information and continue as in 2 above. If presence of BCCH scheduling information in SYSTEM INFORMATION TYPE 9 message is not indicated, it shall assume that there is no valid BCCH scheduling information.

### 3.3.1.1.1 Permission to access the network

All mobile stations with an inserted SIM are members of one out of 10 access classes numbered 0 to 9. The access class number is stored in the SIM. In addition, mobile stations may be members of one or more out of 5 special access classes (access classes 11 to 15) (see 3GPP TS 22.011), this is also held on the SIM card.

The system information messages on the BCCH broadcast the list of authorized access classes and authorized special access classes in the system information messages.

If the establishment cause for the request of the MM sublayer is not "emergency call", access to the network is allowed if and only if the mobile station is a member of at least one authorized:

- access class; or
- special access class.

### 3.3.1.1.3.2 Assignment rejection

If no channel is available for assignment, the network may send to the mobile station an IMMEDIATE ASSIGNMENT REJECT message in unacknowledged mode on the same CCCH timeslot on which the channel request message was received. There is no further restriction on what part of the downlink CCCH timeslot an IMMEDIATE ASSIGNMENT REJECT message can be sent. This message contains the request reference and a wait indication.

On receipt of an IMMEDIATE ASSIGNMENT REJECT message corresponding to one of its 3 last CHANNEL REQUEST messages, the mobile station, stops sending CHANNEL REQUEST messages, starts timer T3122 with the indicated value, ("wait indication" information element), starts T3126 if it has not already been started, and listens to the downlink CCCH until T3126 expires. During this time, additional IMMEDIATE ASSIGNMENT REJECT messages are ignored, but any immediate assignment corresponding to any other of its 3 last CHANNEL REQUEST messages make the mobile station follow the procedure in clause 3.3.1.2. If no such immediate assignment is received, the mobile station returns to CCCH idle mode (listening to its paging channel).

As an option the mobile station may return to CCCH idle mode as soon as it has received responses from the network on all, or in case more than 3 were sent the last 3, of its CHANNEL REQUEST messages.

The mobile station is not allowed to make a new attempt to establish a non emergency RR connection in the same cell until T3122 expires.

The Wait Indication IE (i.e. T3122) relates to the cell from which it was received.

The mobile station in packet idle mode (only applicable to mobile station supporting GPRS) may initiate packet access in the same cell before T3122 has expired, see 3GPP TS 04.60 and clause 3.5.2.1.3.4.

After T3122 expiry, no CHANNEL REQUEST message shall be sent as a response to a page until a PAGING REQUEST message for the mobile station is received.

#### 3.3.1.1.4.1 Early classmark sending

Early classmark sending consists in the mobile station sending as early as possible after access a CLASSMARK CHANGE message to provide the network with additional classmark information.

A mobile station which implements the "Controlled Early Classmark Sending" option shall perform the early classmark sending if and only if explicitly accepted by the network, as indicated in the last reception in the accessed cell of the SYSTEM INFORMATION TYPE 3 message.

A mobile station which implements support for multiple band shall also implement the "Controlled Early Classmark Sending" option.

A mobile station which implements the "multislot capability" option shall also implement the "Controlled Early Classmark Sending" option.

A mobile station that implements some form of treatment of UCS2 alphabet (see GSM 03.38) encoded character string (e.g. in short message, or in USSD string) may indicate so in the classmark. (An example is a Mobile Equipment able to display UCS2 encoded character string.) In such a case, it should also implement the "Controlled Early Classmark Sending" option. It is the mobile station responsibility to provide the UCS2 support information in due time. If the network needs this information and the mobile station did not provide it, the network may assume that the Mobile Equipment does not support UCS2.

A mobile station which implements the R-GSM band (see 3GPP TS 05.05) shall also implement the "Controlled Early Classmark Sending" option.

A mobile station which implements the extended measurement function shall also implement the "Controlled Early Classmark Sending" option.

A mobile station which implements the "GPRS" option shall also implement the "Controlled Early Classmark Sending" option.

A mobile station which implements the "SoLSA" option shall also implement the "Controlled Early Classmark Sending" option.

A mobile station which implements the "EDGE" option shall also implement the "Controlled Early Classmark Sending" option.

A mobile station which implements the "LCS" option shall also implement the "Controlled Early Classmark Sending" option.

A mobile station which implements the "Controlled Early Classmark Sending" option shall indicate it in the classmark (ES IND bit).

#### 3.3.2.1 Paging initiation by the network

The network initiates the paging procedure to trigger RR connection establishment by broadcasting a paging request message on the appropriate paging subchannel on CCCH or PCCCH, and starts timer T3113. The paging subchannels on CCCH and PCCCH are specified in 3GPP TS 05.02 and 3GPP TS 03.13.

The network may also send paging related information on PACCH to a mobile station in packet transfer mode, see clause 3.3.2.1.3.

### 3.3.2.1.1 Paging initiation using paging subchannel on CCCH

Paging initiation using the paging subchannel on CCCH is used when sending paging information to a mobile station in idle mode. It is also used when sending paging information to a mobile station in packet idle mode, if PCCCH is not present in the cell.

NOTE 1: There are 3 types of paging messages which may be used on CCCH:

- PAGING REQUEST TYPE 1;
- PAGING REQUEST TYPE 2; and
- PAGING REQUEST TYPE 3.

In a PAGING REQUEST message on CCCH to trigger RR connection establishment, the mobile station shall be identified by the TMSI (non-GPRS TMSI) or its IMSI. If the mobile station is identified by the TMSI, it shall proceed as specified in clause 3.3.2.2.

If the mobile station in packet idle mode is identified by its IMSI, it shall parse the message for a corresponding *Packet Page Indication* field:

- if the *Packet Page Indication* field indicates a paging procedure for RR connection establishment, or the field is not present in the message, the mobile station shall proceed as specified in clause 3.3.2.2;
- if the *Packet Page Indication* field indicates a packet paging procedure, the mobile station shall proceed as specified in clause 3.5.1.2.

A PAGING REQUEST message on CCCH includes for each mobile station that is paged to trigger RR connection establishment an indication which defines how mobiles of different capabilities shall code the establishment cause field in the CHANNEL REQUEST message. The information received in the CHANNEL REQUEST can be used by the network to assign a suitable channel.

A PAGING REQUEST message on CCCH may include more than one mobile station identification.

A PAGING REQUEST TYPE 1 message on CCCH may have additionally a notification message coded in the P1 rest octets information element.

A PAGING REQUEST message on CCCH may also include priority levels related to the mobile station identifications. A mobile station not supporting eMLPP shall ignore this information element when received in a PAGING REQUEST message.

NOTE 2: A mobile station not supporting VGCS or VBS may ignore this information element when received in a PAGING REQUEST message, since the priority level is also provided in the SETUP message.

The choice of the message type depends on the number of mobile stations to be paged and of the types of identities that are used. The maximum number of paged mobile stations per message is 4 when using only TMSIs for identification of the mobile stations.

The mobile station in idle mode is required to receive and analyse the paging messages and immediate assignment messages sent on the paging subchannel corresponding to its paging subgroup, as specified in 3GPP TS 05.02.

NOTE 3: The possible immediate assignment messages are: the IMMEDIATE ASSIGNMENT, the IMMEDIATE ASSIGNMENT EXTENDED and the IMMEDIATE ASSIGNMENT REJECT messages.

The paging and immediate assignment type messages contain a page mode information element. This information element controls possible additional requirements on mobile stations belonging to the paging subgroup corresponding to the paging subchannel the message was sent on. This implies that a given mobile station shall take into account the page mode information element of any message sent on its own paging subchannel whatever the nature of this message (paging messages or immediate assignment messages). This further implies that the mobile station does not take into account page mode information element of messages sent on paging subchannels other than its own paging subchannel. The requirements yielded by the page mode information element are as follows:

- a) normal paging: no additional requirements;
- b) extended paging: the mobile station is required in addition to receive and analyse the next but one message on the PCH;

- c) paging reorganization: The mobile station shall receive all messages on the CCCH regardless of the BS-AG-BLKS-RES setting. It is required to receive all BCCH messages. When the mobile station receives the next message to its (possibly new) paging subgroup the subsequent action is defined in the page mode information element in that message;
- d) same as before: No change of page mode from the previous page mode.

Note that a mobile station takes into account the page mode information only in messages of its own paging subchannel whatever the currently applied requirements (a, b, c or d).

When the mobile station selects a new PCH, the initial page mode in the mobile station shall be set to paging reorganization. If a message in the paging subchannel is not received correctly, the message is ignored and the previous page mode is assumed.

## 3.4 Procedures in dedicated mode

Procedures described in this clause apply to the dedicated mode.

### 3.4.1.1 General

In dedicated mode, the SACCH is used in signalling layer at least for measurement results transmission from the mobile station.

The SACCH has the particularity that continuous transmission must occur in both directions at least on the channel carrying the main signalling link. For that purpose, in the mobile station to network direction, measurement result messages are sent at each possible occasion when nothing else has to be sent (see clause 3.4.1.2). Similarly, SYSTEM INFORMATION TYPE 5, 6 and optionally 5bis and 5ter messages are sent in the network to mobile station direction in UI frames when nothing else has to be sent.

The network may in addition send MEASUREMENT INFORMATION messages on the SACCH, which may order the MS to use the enhanced measurement report.

In a multislot configuration the SYSTEM INFORMATION TYPE 5, 6 and optionally 5bis, 5ter and MEASUREMENT INFORMATION messages shall be sent on the SACCH associated with the channel carrying the main signalling link.

In a multislot configuration the mobile station shall ignore all messages received on the SACCH(s) that are not associated with the channel carrying the main signalling link.

A mobile station with extended measurement capabilities which receives EXTENDED MEASUREMENT ORDER (EMO) messages on the SACCH, shall perform and report extended measurements, see clause 3.4.1.3.

The SYSTEM INFORMATION TYPE 5bis message shall be sent if and only if the EXT IND bit in the Neighbour Cell Description information element in both the SYSTEM INFORMATION TYPE 5 and TYPE 5bis messages indicates that each information element only carries part of the BA.

A GSM 900 mobile station which only supports the primary GSM band P-GSM 900 (see 3GPP TS 05.05) may consider the EXT-IND bit in the Neighbour cell description IE in the SYSTEM INFORMATION TYPE 5 message bit as a spare bit, assume that the information element carries the complete BA, and ignore any SYSTEM INFORMATION TYPE 5bis messages.

**NOTE:** The network should take into account limitations of certain mobile stations to understand SYSTEM INFORMATION TYPE 5ter and TYPE 5bis messages, the EXT-IND bit in the Neighbour cell description, and formats used in the Neighbour cell description information element and Cell Channel Description information element used in SYSTEM INFORMATION messages, see clauses 10.5.2.1b and 10.5.2.22.

As specified in 3GPP TS 05.08, problems occurring in the reception of SACCH frames are interpreted as a loss of communication means and appropriate procedures are then triggered as specified in clause 3.4.13.



### 3.4.1.2 Measurement report and Enhanced Measurement Report

When in dedicated mode, the mobile station regularly sends either MEASUREMENT REPORT or ENHANCED MEASUREMENT REPORT messages to the network. These messages contain measurement results about reception characteristics from the current cell and from neighbour cells. The BA (list) which is the initial basis for the measurements is derived from information received on the BCCH in System Information 2 and optionally 2bis and/or 2ter and on the SACCH in System Information 5 and optionally 5bis and/or 5ter. The MEASUREMENT INFORMATION message may add information for the GSM Neighbour Cell List. The Mobile Station shall use ENHANCED MEASUREMENT REPORT messages instead of MEASUREMENT REPORT messages if that is indicated by the parameter REPORT\_TYPE and if at least one BSIC is allocated to each BA (list) frequency. For report with the MEASUREMENT REPORT message, reporting is performed on one list: the BA (list). For report with the ENHANCED MEASUREMENT REPORT message, reporting is performed on the Neighbour Cell List (defined in clause 3.4.1.2.1.3).

In addition, the MS which implements ECSD options shall use fast inband procedure for downlink quality reporting if the use of such procedure has been ordered by the BSC.

When the information is received in more than one message the mobile station shall only combine information relating to the BA (list) from messages received on the same channel and indicating the same value of the BCCH allocation sequence number (BA\_IND) without any message indicating a different value of BA\_IND received in between. If neighbour cell information for the serving cell is not available, the mobile station indicates this in the MEASUREMENT REPORT message. These measurement results are obtained as specified in 3GPP TS 05.08.

These messages are sent on the slow ACCH, in unacknowledged mode.

If no other message is scheduled on the SACCH at the instant when a layer 2 frame is due to be sent, then the mobile station shall send a MEASUREMENT REPORT message or an ENHANCED MEASUREMENT REPORT or an EXTENDED MEASUREMENT REPORT message (see clause 3.4.1.3) in that frame. The interval between two successive layer 2 frames containing messages for measurement reporting shall not exceed one layer 2 frame.

#### 3.4.1.2.1 Parameters for Measurements and Reporting

Parameters from the Measurement Information allow to build lists which are used for Measurement reporting and Enhanced Measurement reporting.

A full set/all instances of MEASUREMENT INFORMATION messages is defined by a number of different instances indicated by the parameter MI\_COUNT. Two different instances of MEASUREMENT INFORMATION messages are two MEASUREMENT INFORMATION messages with different MI\_INDEX parameter values.

For the GSM neighbour cell list the MS shall combine the BA (list) received in SI5/SI5bis/SI5ter with the BSIC list received in one or more instances of the MEASUREMENT INFORMATION message with the same BA\_IND value as the BA (list). When the BA\_IND is changed the MS shall rebuild the combined list (the BSIC list shall also be rebuilt).

The MS shall combine the BA (list) with the Real Time Differences parameters received in the MEASUREMENT INFORMATION message with the same BA\_IND value as the BA (list). When the BA\_IND is changed the MS shall re-read the Real Time Differences parameters in all instances.

The MS shall combine the Neighbour Cell list with the REP\_PRIORITY parameters received in the MEASUREMENT INFORMATION message with the same BA\_IND as the Neighbour Cell list. When the BA\_IND is changed the MS shall re-read the REP\_PRIORITY parameters in all instances.

If the MP\_CHANGE\_MARK parameter is changed, the MS shall re-read the Real Time differences, REP\_PRIORITY, Measurement Parameters in all instances. The MS shall start using the parameters as soon as they have been received. In the case that not all the parameters have been received in a full set of instances, then the default values shall be used. If different values occur for the same parameter in different instances of a message, the instance with the highest index shall be used.

##### 3.4.1.2.1.2 Deriving the GSM Neighbour Cell list from the BSICs and the BA (list)

One or more instances of the Measurement Information message may provide BSIC information. This is used to build the GSM Neighbour Cell list. The GSM Neighbour Cell list may contain up to 96 Neighbour Cells.

The BSICs are associated to the frequencies in the BA (list) with the same BA\_IND value. The BSICs may be received before the corresponding BA (list). The first BSIC in each instance applies to the frequency in the BA (list) referenced by the parameter BA\_Index\_Start\_BSIC. For each successive BSIC, one bit indicates if the BSIC applies to the same frequency as the previous BSIC or to the next frequency in the BA (list), as defined in clause 9.1.54 "Measurement Information message".

#### 3.4.1.2.1.3 Deriving the Neighbour Cell list from the GSM Neighbour Cell list

For report with the ENHANCED MEASUREMENT REPORT message, the Neighbour Cell list is the GSM Neighbour Cell list. The Neighbour Cell list may contain up to 96 Neighbour Cells.

NOTE: For report with the MEASUREMENT REPORT MESSAGE, the concatenated list is not used. Instead, the two lists are used separately, as defined in clause 10.5.2.20 "Measurement Results".

#### 3.4.1.2.1.4 Real Time Differences

One or more instances of the Measurement Information message may provide Real Time Difference information. This is used to build the Real Time Difference list. The Real Time Difference list may contain up to 96 Real Time Difference parameters.

The Real Time Difference list is associated with the BA (list) having the same BA\_IND value. Each frequency in the BA (list) can be associated to 0, 1 or more Real Time Difference parameters. The Real Time Difference parameters may be received before the corresponding BA (list). The parameter BA\_Index\_Start\_RTD in each structure indicates the index of the frequency in the BA (list) to be taken as a starting reference. A sub-structure is included for each frequency referenced. Each of those sub-structures indicates if 0, 1 or more RTD parameters are present for this frequency. If a frequency in the BA (list) is not provided with Real Time Difference information by any of the message instances with correct BA\_IND, it shall be assumed that no information is available for that frequency, see clause 9.1.54 "Measurement Information message".

### 3.4.1.3 Extended measurement report \$(MAFA)\$

Only applicable to mobile stations which support extended measurement.

When in dedicated mode, a mobile station may receive an EXTENDED MEASUREMENT ORDER (EMO) message, from the network. The mobile station shall then, as defined in 3GPP TS 05.08, for one reporting period perform measurements on the frequencies specified by this EMO message. The mobile station shall thereafter send an EXTENDED MEASUREMENT REPORT message. This message contains the measurement results as defined in 3GPP TS 05.08.

If the mobile station has not started to send its EXTENDED MEASUREMENT REPORT within 10 seconds after the reception of the EMO message, no EXTENDED MEASUREMENT REPORT shall be sent. The mobile station shall after a successful channel change abort any pending measurements or reporting related to an EMO message received on the old channel.

If a mobile station receives an EMO message indicating the same value of the sequence code as an EMO message received earlier on the same channel without having received any EMO message indicating a different value of the sequence code in between, that EMO message shall be ignored. If the mobile station, before the reporting related to an EMO message has started, receives a new EMO message with a different value of the sequence code, any pending measurements or reporting related to the earlier EMO message shall be aborted and the new message treated.

The EMO message and the EXTENDED MEASUREMENT REPORT message are sent on the SACCH, in unacknowledged mode.

## 3.4.2 Transfer of messages and link layer service provision

When in dedicated mode, upper layers can send messages in multiframe or unacknowledged mode on SAPI 0.

Moreover, but only when in dedicated mode, upper layers have access to the full link layer services for SAPIs other than 0, with the exception of the error indication and local end release that are directly treated by the RR sublayer, as specified in particular places of clause 3.

### 3.4.3 Channel assignment procedure

In dedicated mode, an intracell change of channel can be requested by upper layers for changing the channel type, or decided by the RR sublayer, e.g. for an internal handover. This change may be performed through the dedicated channel assignment procedure.

The purpose of the channel assignment procedure is to completely modify the physical channel configuration of the mobile station without frequency redefinition or change in synchronization while staying in the same cell.

This procedure shall not be used for changing between dependent configurations, i.e. those sharing Radio Resource for the main signalling link. An example of dependent channels is a full rate channel and one of the corresponding half rate channels. In multislot operation however, it is allowed to use the same timeslots before and after the assignment, as long as the main signalling link has been changed. The only procedures provided for changing between dependent configurations for the main signalling link are the additional assignment and the partial release procedures.

The channel assignment procedure happens only in dedicated mode. This procedure cannot be used in the idle mode; in this case the immediate assignment procedure is used.

The channel assignment procedure includes:

- the suspension of normal operation except for RR management (layer 3);
- the release of the main signalling link, and of the other data links as defined in clause 3.1.4, the disconnection of TCHs if any;
- the deactivation of previously assigned channels (layer 1);
- the activation of the new channels and their connection if applicable;
- the triggering of the establishment of the data link connections for SAPI = 0.

The channel assignment procedure is always initiated by the network.

#### 3.4.3.1 Channel assignment initiation

The network initiates the channel assignment procedure by sending an ASSIGNMENT COMMAND message to the mobile station on the main signalling link. It then starts timer T3107.

**NOTE:** The network should take into account limitations of certain mobile stations to understand formats used in the Frequency List IE and Cell Channel Description IE used in the ASSIGNMENT COMMAND message, see clauses 10.5.2.13 and 10.5.2.1b.

When sending this message on the network side, and when receiving it on the mobile station side, all transmission of signalling layer messages except for those RR messages needed for this procedure and for abnormal cases is suspended until resumption is indicated. These RR messages can be deduced from clauses 3.4.3 and 8.8 "Radio Resource management".

Upon receipt of the ASSIGNMENT COMMAND message, the mobile station initiates a local end release of link layer connections and packet resources, if in dual transfer mode, disconnects the physical channels, commands the switching to the assigned channels and initiates the establishment of lower layer connections (this includes the activation of the channels, their connection and the establishment of the main signalling links).

The ASSIGNMENT COMMAND message contains the description of the new configuration. The power level defined in this power command shall be used by the mobile station for the initial power on the new channel(s). It shall not affect the power used on the old channel(s). The message may also contain definitions of the channel mode to be applied for one or several channel sets. If a previously undefined channel set is defined by the ASSIGNMENT COMMAND message, a definition of the channel mode for the new channel set shall be included in the message.

An ASSIGNMENT COMMAND message may indicate a frequency change in progress, with a starting time and possibly alternative channel descriptions.

In the case of the reception of an ASSIGNMENT COMMAND message which contains only the description of a channel to be used after the starting time, the mobile station shall wait up to the starting time before accessing the channel. If the starting time has already elapsed, the mobile shall access the channel as an immediate reaction to the reception of the message (see TS 100 912 for the timing constraints).

If the message contains both the description of a channel to be used after the indicated time and of a channel to be used before, the mobile station accesses a channel as an immediate reaction to the reception of the message. If the moment the mobile station is ready to access is before the indicated time, the mobile station accesses the channels described for before the starting time. The mobile station then changes to the channel described for after the starting time at the indicated time. New parameters can be frequency list, MAIO and HSN. Other parameters describing the allocated channels must be identical to the parameters described for before the starting time. If the moment the mobile station is ready to access is after the starting time, the mobile station accesses the channel described for after the starting time.

If frequency hopping is applied, the cell allocation if present in the message is used to decode the mobile allocation. If the cell allocation is not included, the mobile station uses its current cell allocation, the current CA is the last CA received on the BCCH. Afterward, the current CA may be changed by some messages sent on the main signalling link containing a CA (the possible messages are: ASSIGNMENT COMMAND, HANDOVER COMMAND and FREQUENCY REDEFINITION). Note that there are cases in which the current CA is undefined, see clause 3.4.3.3.

The ASSIGNMENT COMMAND message may contain a cipher mode setting IE. In that case, this ciphering mode has to be applied on the new channel. If no such information is present, the ciphering mode is the same as on the previous channel. In either case the ciphering key shall not be changed. The ASSIGNMENT COMMAND message shall not contain a cipher mode setting IE that indicates "start ciphering" unless a CIPHERING MODE COMMAND message has been transmitted earlier in the RR connection: if such an ASSIGNMENT COMMAND message is received it shall be regarded as erroneous, an ASSIGNMENT FAILURE with cause "Protocol error unspecified" message shall be returned immediately, and no further action taken.

### 3.4.3.3 Abnormal cases

If the mobile station has no current CA and if it needs a CA to analyse the ASSIGNMENT COMMAND message, it stays on the current channel(s) and sends an ASSIGNMENT FAILURE message with cause "no cell allocation available".

If the ASSIGNMENT COMMAND message instructs the mobile station to use a Channel Description or Mode that it does not support, or if the Channel Mode to use is not defined for all channel sets, then the mobile station shall return an ASSIGNMENT FAILURE message with cause "channel mode unacceptable", and the mobile station shall remain on the current channel(s) and uses the old Channel Description or Channel Mode(s).

If the ASSIGNMENT COMMAND message instructs the mobile station to use a frequency that it is not capable of, then the mobile station shall return an ASSIGNMENT FAILURE message with cause "frequency not implemented", and the mobile station shall remain on the current channel(s).

If the mobile station receives an ASSIGNMENT COMMAND message with a Frequency List IE indicating frequencies that are not all in one band, then the mobile station shall stay on the current channel(s) and send an ASSIGNMENT FAILURE message with cause "frequency not implemented". If the mobile station receives an ASSIGNMENT COMMAND message with a Mobile Allocation IE indexing frequencies that are not all in one band, then the mobile station shall stay on the current channel(s) and send an ASSIGNMENT FAILURE message with cause "frequency not implemented".

**NOTE:** An ASSIGNMENT COMMAND message sent to a multi band mobile station shall not be considered invalid because it indicates frequencies that are all in a different frequency band to that of the current channel.

On the mobile station side, if a lower layer failure happens on the new channel before the ASSIGNMENT COMPLETE message has been sent, the mobile station deactivates the new channels, reactivates the old channels, reconnects the TCHs if any and triggers the establishment of the main signalling link. It then sends a ASSIGNMENT FAILURE message, cause "protocol error unspecified" on the main DCCH and resumes the normal operation, as if no assignment attempt had occurred. The operational parameters (e.g. ciphering mode) when returning on the old channel are those applied before the procedure.

When receiving the ASSIGNMENT FAILURE message, the network stops T3107.

If a lower layer failure happens while attempting to connect back to the old channels, the radio link failure procedure is applied (see clause 3.4.13.2 for dedicated mode).

On the network side, if timer T3107 elapses before either the ASSIGNMENT COMPLETE message has been received on the new channels or an ASSIGNMENT FAILURE message is received on the old channels, the old channels and the new channels are released if they both were dedicated channels and, unless the mobile station has re-established the call, all contexts related to the connections with that mobile station are cleared.

On the network side, lower layer failure occurring on the old channels after the sending of the ASSIGNMENT COMMAND message are ignored. Lower layer failures occurring after the receipt of the SABM Frame on the new main signalling link are treated following the general rules (see clause 3.5.2).

### 3.4.4 Handover procedure

In dedicated mode, an intercell or intracell change of channel(s) can be requested by the network RR sublayer. This change may be performed through the handover procedure

NOTE: The decision to do a handover and the choice of the new cell is out of the scope of the present document.

The purpose of the handover procedure is to completely modify the channels allocated to the mobile station, e.g. when the cell is changed. A change in the channel configuration nature is possible. This procedure is used only while in dedicated mode.

The handover procedure is also used by Location Services as described in GSM 03.71.

The handover procedure shall not be used for changing between dependent configurations (see clause 3.4.3). An exception to this is when the handover procedure is used by Location Services. In this case the mobile may be commanded to attempt a handover to the same channel as currently assigned to the MS. The MS shall attempt to perform a handover to this unchanged channel, which includes the transmission of access bursts.

The handover procedure includes:

- The suspension of normal operation except for RR management (layer 3).
- The disconnection of the main signalling link, and of the other links via local end release (layer 2), and the disconnection of the TCH(s) if any.
- The disconnection and the deactivation of previously assigned channels and their release (layer 1).
- The activation of the new channels, and their connection if applicable.
- The triggering of the establishment of data link connection for SAPI = 0 on the new channels.

The handover procedure is always initiated by the network.

#### 3.4.4.1 Handover initiation

The network initiates the handover procedure by sending a HANOVER COMMAND message to the mobile station on the main DCCH. It then starts timer T3103.

NOTE: The network should take into account limitations of certain mobile stations to understand formats used in the Frequency List IE, Frequency Short List IE, and Cell Channel Description IE used in the HANOVER COMMAND message, see clauses 10.5.2.13, 10.5.2.14 and 10.5.2.1b.

When sending this message on the network side, and when receiving it on the mobile station side, all transmission of signalling layer messages except for those RR messages needed for this procedure and for abnormal cases, is suspended until resuming is indicated. These RR messages can be deduced from clauses 3.4.3 and 8.5.1 "Radio Resource management".

Upon receipt of the HANOVER COMMAND message, the mobile station initiates, as described in clause 3.1.4, the release of link layer connections, disconnects the physical channels, commands the switching to the assigned channels and initiates the establishment of lower layer connections (this includes the activation of the channels, their connection and the establishment of the data links).

The HANOVER COMMAND message contains:

- The characteristics of the new channels.
- The characteristics of the new cell that are necessary to successfully communicate (e.g. frequency list in the case of slow frequency hopping), including the data that allows the mobile station to use the pre-knowledge about synchronization it acquires by the measurement process (i.e. BSIC + BCCH frequency).

- A power command (see 3GPP TS 05.08). The power level defined in this power command shall be used by the mobile station for the initial power on the new channel(s). It shall not affect the power used on the old channel(s).
- An indication of the physical channel establishment procedure to be used.
- A handover reference, used as specified in the following clause. The choice of the handover reference by the network is out of the scope of this specification and left to the manufacturers.
- Optionally a timing advance to be used on the new cell.
- Optionally a cipher mode setting. In that case, this ciphering mode has to be applied on the new channel. If no such information is present, the ciphering mode is the same as on the previous channel. In either case the ciphering key shall not be changed. The HANDOVER COMMAND message shall not contain a cipher mode setting IE that indicates "start ciphering" unless a CIPHERING MODE COMMAND message has been transmitted previously in this instance of the dedicated mode: if such a HANDOVER COMMAND message is received it shall be regarded as erroneous, a HANDOVER FAILURE message with cause "Protocol error unspecified" shall be returned immediately, and no further action taken.

In addition, a HANDOVER COMMAND message may indicate a frequency change in progress, with a starting time and possibly alternative channel descriptions.

In the case of the reception of a HANDOVER COMMAND message which contains only the description of a channel to be used after the starting time, the mobile station shall wait up to the starting time before accessing the channel. If the starting time has already elapsed, the mobile shall access the channel as an immediate reaction to the reception of the message (see TS 100 912 for the timing constraints).

If the message contains both the description of a channel to be used after the indicated time and of a channel to be used before, the mobile station accesses a channel as an immediate reaction to the reception of the message. If the moment the mobile station is ready to access is before the indicated time, the mobile station accesses the channels described for before the starting time. The mobile station then changes to the channel described for after the starting time at the indicated time. New parameters can be frequency list, MAIO and HSN. Other parameters describing the allocated channels must be identical to the parameters described for before the starting time. If the moment the mobile station is ready to access is after the starting time, the mobile station accesses the channel described for after the starting time.

### 3.4.4.3 Handover completion

After lower layer connections are successfully established, the mobile station returns a HANDOVER COMPLETE message, specifying cause "normal event", to the network on the main DCCH.

The sending of this message on the mobile station side and its receipt on the network side allow the resumption of the transmission of signalling layer messages other than those for RR management.

When receiving the HANDOVER COMPLETE message, the network stops timer T3103 and releases the old channels.

If requested to do so in the HANDOVER COMMAND message, the mobile station includes the observed time difference it has measured when performing the handover, corrected by half the timing advance, in the HANDOVER COMPLETE message (detailed specifications are given in TS 100 912).

If the new cell supports DTM and the mobile station was in DTM in the old cell or the network does not have enough information about the RR mode in the old cell, the network sends the DTM INFORMATION message on the main DCCH after the HANDOVER COMPLETE message has been received.

### 3.4.4.4 Abnormal cases

In the case of a synchronous or pseudo-synchronous handover, if the mobile station knows that the timing advance with the new cell is out of range, i.e. is bigger than the maximum timing advance that can be coded as specified in 3GPP TS 04.04, and if the new cell does not accept out of range timing advance as indicated in the HANDOVER COMMAND message, the mobile station sends a HANDOVER FAILURE message, cause "handover impossible, timing advance out of range", on the main signalling link and does not attempt that handover.

If the HANDOVER COMMAND message instructs the mobile station to use a Channel Description or Mode that it does not support, then the MS shall return a HANDOVER FAILURE message with cause "channel mode unacceptable", and the MS shall remain on the current channel(s) and uses the old Channel Description or Mode(s).

If the HANOVER COMMAND message instructs the mobile station to use a frequency that it is not capable of, then the mobile station shall return a HANOVER FAILURE message with cause "frequency not implemented", and the mobile station shall remain on the current channel(s).

If the mobile station receives a HANOVER COMMAND message with a Frequency List IE or Frequency Short List IE indicating frequencies that are not all in one band, then the mobile station shall stay on the current channel(s) and send a HANOVER FAILURE message with cause "frequency not implemented". If the mobile station receives a HANOVER COMMAND message with a Mobile Allocation IE indexing frequencies that are not all in one band, then the mobile station shall stay on the current channel(s) and send a HANOVER FAILURE message with cause "frequency not implemented".

NOTE: A HANOVER COMMAND message sent to a multi band mobile station shall not be considered invalid because it indicates target channel frequencies that are all in a different frequency band to that of the ARFCN in the Cell Description IE.

On the mobile station side, if timer T3124 times out (only in the non-synchronized case) or if a lower layer failure happens on the new channel before the HANOVER COMPLETE message has been sent, the mobile station deactivates the new channels, reactivates the old channels, reconnects the TCHs if any and triggers the establishment of the main signalling link. It then sends a HANOVER FAILURE message on the main signalling link and resumes normal operation as if no handover attempt had occurred. The operational parameters (e.g. ciphering mode) when returning on the old channel are those applied before the HANOVER COMMAND message was received.

When the HANOVER FAILURE message has been received, the network releases the new channels if they were dedicated channels and stops timers T3105 and stops T3103 in the non-synchronized case.

If a lower layer failure happens while attempting to connect back to the old channels, the standard rules are applied (see clause 3.4.13.2 for dedicated mode).

On the network side, if timer T3103 elapses before either the HANOVER COMPLETE message is received on the new channels, or a HANOVER FAILURE message is received on the old channels, or the mobile station has re-established the call, the old channels are released if they were dedicated channels and all contexts related to the connections with that mobile station are cleared.

On the network side, if neither a correctly layer 2 frame in format A or B nor a correctly TCH frame have been received from the mobile station on the new channel, the newly allocated channels are released if they were dedicated channels.

On the network side, lower layer failures occurring on the old channels after the sending of the HANOVER COMMAND message are ignored. Lower layer failures occurring after the receipt of the SABM frame on the new main signalling link are treated following a general scheme (see clause 3.4.13.2 for dedicated mode).

### 3.4.5 Frequency redefinition procedure

In dedicated mode, this procedure is used by the network to change the frequencies and hopping sequences of the allocated channels. This is meaningful only in the case of frequency hopping.

The network sends to the mobile station a FREQUENCY REDEFINITION message containing the new parameters together with a starting time indication.

NOTE: The network should take into account limitations of certain mobile stations to understand formats used in the Cell Channel Description IE used in the FREQUENCY REDEFINITION message, see clause 10.5.2.13.

When receiving such a message, the mobile station modifies the frequencies/hopping sequences it uses at the exact indicated time slot, i.e. the indicated time slot is the first with new parameters. All other functions are not disturbed by this change. New parameters can be the cell channel description, the mobile allocation and the MAIO.

### 3.4.7 Ciphering mode setting procedure

In dedicated mode, the ciphering mode setting procedure is used by the network to set the ciphering mode, i.e. whether or not the transmission is ciphered, and if so which algorithm to use. The procedure shall only be used to change from "not ciphered" mode to "ciphered" mode, or vice-versa, or to pass a CIPHERING MODE COMMAND message to the mobile station while remaining in the "not ciphered" mode. The ciphering mode setting procedure is always triggered by the network and it only applies to dedicated resources.

### 3.4.10 Classmark change procedure

In dedicated mode, this procedure allows the mobile station to indicate to the network a change of characteristics reflected in the classmark (e.g. due to addition of power amplification). Furthermore, a mobile station which implements the "controlled early classmark sending" option may also send a CLASSMARK CHANGE message, even if no change of characteristics has occurred

The mobile station sends a CLASSMARK CHANGE message to the network. This message contains the new mobile station classmark 2 information element. It may also contain a Classmark 3 Information Element. There is no acknowledgement from the network at layer 3.

If the CLASSMARK CHANGE and one or more of these additional messages are to be sent by the MS, the CLASSMARK CHANGE message shall be sent first.

### 3.4.11 Classmark interrogation procedure

This procedure allows the network to request additional classmark information from the mobile station (e.g. if the information initially sent by the mobile station is not sufficient for network decisions).

#### 3.4.11.2 Classmark interrogation completion

On receipt of the CLASSMARK ENQUIRY message the mobile station sends a CLASSMARK CHANGE message to the network on the main DCCH. The Classmark Enquiry Mask information element in the CLASSMARK ENQUIRY message indicates the type of request. If the Classmark Enquiry Mask information element is not included in the CLASSMARK ENQUIRY message, this indicates a request for CLASSMARK CHANGE message. The CLASSMARK CHANGE message contains the mobile station classmark 2 information element. It may also contain a Classmark 3 Information Element.

If the CLASSMARK CHANGE and one or more of these additional messages are to be sent by the MS, the CLASSMARK CHANGE message shall be sent first.

#### 3.4.13.1 Normal release procedure

The release of the RR connection can be requested by upper layers.

The purpose of this procedure is to deactivate all the dedicated channels in use. When the channels are released and the mobile station is not IMSI attached for GPRS services (clause 4), the mobile station returns to the CCCH configuration, idle mode.

If the mobile station is IMSI attached for GPRS services the following three cases apply:

- If the mobile station has no radio resources (i.e. no temporary block flow) allocated on a PDCH, the mobile station returns to the PCCCH or CCCH configuration, packet idle mode.
- Otherwise, if the mobile station has radio resources allocated on a PDCH, the mobile station enters packet transfer mode.

The channel release procedure can be used in a variety of cases, including TCH release after a call release, and DCCH release when a dedicated channel allocated for signalling is released.

In dedicated mode, the channel release procedure is always initiated by the network.

##### 3.4.13.1.1 Channel release procedure initiation in dedicated mode

The network initiates the channel release by sending a CHANNEL RELEASE message to the mobile station on the main DCCH, starts timer T3109 and deactivates the SACCH.

On receipt of a CHANNEL RELEASE message the mobile station starts timer T3110 and disconnects the main signalling link. When T3110 times out, or when the disconnection is confirmed, the mobile station deactivates all channels, considers the RR connection as released, and returns to CCCH idle mode, returns to PCCCH or CCCH packet idle mode or enters packet transfer mode.

NOTE 1: Data Links other than the main signalling link are disconnected by local end link release.



If case of dedicated mode, on the network side, when the main signalling link is disconnected, the network stops timer T3109 and starts timer T3111. When timer T3111 times out, the network deactivates the channels, they are then free to be allocated to another connection.

NOTE 2: The sole purpose of timer T3111 is to let some time to acknowledge the disconnection and to protect the channel in case of loss of the acknowledge frame.

If timer T3109 times out, the network deactivates the channels; they are then free to be allocated to another connection.

The CHANNEL RELEASE message will include an RR cause indication as follows:

- #0: if it is a normal release, e.g. at the end of a call or at normal release of a DCCH.
- #1: to indicate an unspecified abnormal release.
- #2, #3 or #4: to indicate a specific release event.
- #5: if the channel is to be assigned for servicing a higher priority call.
- #65: if e.g. a handover procedure is stopped because the call has been cleared.

The CHANNEL RELEASE message may include the information element BA Range which may be used by a mobile station in its selection algorithm (see 3GPP TS 05.08 and 3GPP TS 23.022).

Mobile stations not supporting VGCS or VBS listening shall consider Group Channel Description and Group Cipher Key Number information elements as unnecessary in the message and perform the channel release procedure as normal.

A mobile station not supporting the "GPRS" option shall consider the GPRS Resumption information element as an information element unknown in the CHANNEL RELEASE message and perform the RR connection release procedure as normal.

For a mobile station supporting the "GPRS" option, the following additional procedures also apply:

- The CHANNEL RELEASE message may include the information element GPRS Resumption. If the GPRS Resumption information element indicates that the network has resumed GPRS services, the RR sublayer of the mobile station shall indicate a RR GPRS resumption complete to the MM sublayer, see clause 4. If the GPRS Resumption information element indicates that the network has not successfully resumed GPRS services, the RR sublayer of the mobile station shall indicate a RR GPRS resumption failure to the MM sublayer, see clause 4.
- If the mobile station has performed the GPRS suspension procedure (clause 3.3.1.1.4.2) and the GPRS Resumption information element is not included in the message, the RR sublayer of the mobile station shall indicate a RR GPRS resumption failure to the MM sublayer, see clause 4.
- If the mobile station has not performed the GPRS suspension procedure and the GPRS Resumption information element is not included in the message, the mobile station shall perform the RR connection release procedure as normal.

### 3.4.13.2 Radio link failure in dedicated mode

The main part of these procedures concerns the "normal" cases, i.e. those without any occurrence of loss of communication means. A separate paragraph at the end of the description of each procedure treats the cases of loss of communication, called a radio link failure. In dedicated mode, in most of the cases the reaction of the mobile station or the network is the same. Those reactions are described in this clause to avoid repetitions.

A radio link failure can be detected by several ways:

- 1) By analysis of reception at layer 1, as specified in 3GPP TS 05.08 and clause 3.4.1.1.
- 2) By a data link layer failure as specified in EN 300 938, on the main signalling link. A data link failure on any other data link shall not be considered as a radio link failure.
- 3) When a lower layer failure happens while the mobile station attempts to connect back to the old channels in a channel assignment procedure, handover procedure, PDCH assignment procedure, RR-cell change order procedure or DTM assignment procedure with relocation of the RR connection.
- 4) In some cases where timers are started to detect the lack of answer from the other party, as described in clause 3.

The two first cases are known by the term "lower layer failure".

#### 3.4.13.2.1 Mobile side

When a radio link failure is detected by the mobile station:

- the MS shall perform a local end release on all signalling links unless otherwise specified;
- the mobile station shall deactivate all dedicated channels;
- the RR sublayer of the mobile station shall indicate an RR connection failure to the MM sublayer unless otherwise specified.

NOTE: Upper layers may decide on a re-establishment (see clause 5.5.4).

#### 3.4.13.2.2 Network side

In dedicated mode, the reaction of the network to a lower layer failure depends on the context. Except when otherwise specified, it is to release the connection either with the channel release procedure as specified in clause 3.5.1, or with the following procedure. The network starts timer T3109 and deactivates the SACCH (and hence to stop transmission on the SACCH).

When a radio link failure has been detected, an indication is passed to the upper Mobility Management sublayer on the network side.

When timer T3109 expires, the network can regard the channels as released and free for allocation.

This procedure relies on the fact that if a mobile station does not receive the SACCH for some time, it completely releases the channels (see 3GPP TS 05.08).

NOTE: The network should maintain for a while the transaction context in order to allow call re-establishment. The length of timer is for further study.

When a mobile station which has performed the GPRS suspension procedure (clause 3.3.1.1.4.2) detects a radio link failure, the RR sublayer of the mobile station shall indicate a RR GPRS resumption failure to the MM sublayer, see clause 4.

#### 3.4.13.3 RR connection abortion in dedicated mode

The mobile station aborts the RR connection by initiating a normal release of the main signalling link, performing local end releases on all other signalling links, disconnecting all traffic channels, if any, and aborting all the packet resources, if any.

When a mobile station which has performed the GPRS suspension procedure (clause 3.3.1.1.4.2) aborts the RR connection, the RR sublayer of the mobile station shall indicate a RR GPRS resumption failure to the MM sublayer, see clause 4.

### 3.4.19 Assignment to a Packet Data channel

This clause is only applicable to mobile stations supporting the <<GPRS>> option.

When in dedicated mode, the network may wish to change the resources used by a mobile station that supports the <<GPRS option>>. This change may be performed through the assignment to a Packet Data Channel procedure.

The purpose of the assignment to PDCH channel procedure is to completely modify the physical channel configuration of the mobile station without frequency redefinition or change in synchronization while staying in the same cell.

The assignment to PDCH procedure only commences in dedicated mode. This procedure cannot be used in the idle mode.

The assignment to PDCH procedure includes:

- the suspension of normal operation;
- the release of the main signalling link, and of the other data links as defined in clause 3.1.4, and the disconnection of TCHs if any;
- the deactivation of previously assigned channels (layer 1);
- The triggering of the establishment of a Temporary Block Flow.

The assignment to PDCH procedure is always initiated by the network.

### 3.4.19.3 Abnormal cases

If the mobile station has no current CA and if it needs a CA to analyse the PDCH ASSIGNMENT COMMAND message, it stays on the current channel(s) and sends an ASSIGNMENT FAILURE message with cause "no cell allocation available".

If the PDCH ASSIGNMENT COMMAND message instructs the mobile station to use a Coding Scheme that it does not support then the mobile station shall return an ASSIGNMENT FAILURE message with cause "channel mode unacceptable", and the mobile station shall remain on the current channel(s) and uses the old Channel Description or Channel Mode(s).

If the PDCH ASSIGNMENT COMMAND message instructs the mobile station to use a frequency that it is not capable of, then the mobile station shall return an ASSIGNMENT FAILURE message with cause "frequency not implemented", and the mobile station shall remain on the current channel(s).

If the mobile station receives a PDCH ASSIGNMENT COMMAND message with a Frequency List IE indicating frequencies that are not all in one band, then the mobile station shall stay on the current channel(s) and send an ASSIGNMENT FAILURE message with cause "frequency not implemented". If the mobile station receives a PDCH ASSIGNMENT COMMAND message with a Mobile Allocation IE indexing frequencies that are not all in one band, then the mobile station shall stay on the current channel(s) and send an ASSIGNMENT FAILURE message with cause "frequency not implemented".

**NOTE:** A PDCH ASSIGNMENT COMMAND message sent to a multi band mobile station shall not be considered invalid because it indicates frequencies that are all in a different frequency band to that of the current channel.

On the mobile station side, if RLC/MAC blocks are not successfully received within T3190 seconds, the mobile station reactivates the old channels, reconnects the TCHs if any and triggers the establishment of the main signalling link. It then sends an ASSIGNMENT FAILURE message, cause "protocol error unspecified" on the main DCCH and resumes the normal operation, as if no assignment attempt had occurred. The operational parameters (e.g. ciphering mode) when returning on the old channel are those applied before the procedure.

When receiving the ASSIGNMENT FAILURE message, the network stops T3117.

If a lower layer failure happens while attempting to connect back to the old channels, the radio link failure procedure is applied (see clause 3.4.13.2).

On the network side, if timer T3117 elapses before either the network receives an RLC/MAC block from the mobile station on the new channel, or, an ASSIGNMENT FAILURE message is received on the old channels, then the old channels and the new resources are released.

On the network side, lower layer failure occurring on the old channels after the sending of the PDCH ASSIGNMENT COMMAND message are ignored.

### 3.4.20 RR-Network Commanded Cell Change Order

This clause is only applicable to mobiles supporting the <<GPRS>> option.

In dedicated mode, intracell or intercell change of channel(s) can be requested by the network RR sublayer. This change may be performed through the RR-network commanded cell change order procedure.

The purpose of the RR-network commanded cell change order procedure is to permit the complete modification of the channels allocated to the mobile station e.g. when the cell is changed. This procedure only commences while in dedicated mode.

The RR-network commanded cell change order procedure includes:

- The suspension of normal operation except for RR management (layer 3).
- The disconnection of the main signalling link, and of the other links via local end release (layer 2), and the disconnection of the TCH(s) if any.
- The disconnection and the deactivation of previously assigned channels and their release (layer 1).
- The complete acquisition of BCCH or PBCCH messages of the target cell.
- The triggering of the establishment of a Temporary Block Flow.

The RR-network controlled cell change order procedure is always initiated by the network.

### 3.4.20.1 RR-network commanded cell change order initiation

The network initiates the RR-network controlled cell change order procedure by sending a RR-CELL CHANGE ORDER message to the mobile station on the main DCCH. The network then starts timer T3119.

When a handover has taken place during dedicated connection, the network shall send a RR-CELL CHANGE ORDER message to the mobile station in order to establish TBF. In this case the target cell is equal to the old cell.

When sending this message on the network side, and when receiving it on the mobile station side, all transmission of signalling layer messages except for those RR messages needed for this procedure and for abnormal cases, is suspended until resuming is indicated. These RR messages can be deduced from clauses 3.4.3 and 8.5.1 "Radio Resource management".

Upon receipt of the RR-CELL CHANGE ORDER message, the mobile station starts timer T3134, and initiates, as described in clause 3.1.4, the release of link layer connections, disconnects the physical channels, commands the switching to the identified cell, performs a complete acquisition of BCCH or PBCCH messages (see 3GPP TS 04.60), and obeys the procedures relevant to the establishment of the Temporary Block Flow. The mobile station shall obey the RR-CELL CHANGE ORDER irrespective of whether or not the mobile station has any knowledge of the relative synchronization of the target cell to the serving cell.

The RR-CELL CHANGE ORDER message contains:

- the characteristics of the new cell that are necessary to identify it (i.e. BSIC + BCCH frequency);
- the NC mode to be initially applied on the new cell.

The RR-CELL CHANGE ORDER does not contain a cipher mode setting IE. Any RR layer ciphering that may have been applied in dedicated mode shall not be applied to the target TBF or with the target cell.

### 3.4.20.3 Abnormal cases

If the RR-CELL CHANGE ORDER message instructs the mobile station to use a frequency that it is not capable of, then the mobile station shall return a HANDOVER FAILURE message with cause "frequency not implemented", and the mobile station shall remain on the current channel(s).

On the mobile station side, if timer T3134 times out before a response to the (PACKET) CHANNEL REQUEST message has been received, or, if an IMMEDIATE ASSIGNMENT REJECT message or a PACKET ACCESS REJECT is received from the new cell, or, if the contention resolution procedure fails on the new cell then the mobile station shall reactivate the old channels, reconnect the TCHs if any and trigger the establishment of the main signalling link. It then sends a HANDOVER FAILURE message on the main signalling link and resumes normal operation as if no handover attempt had occurred. The operational parameters (e.g. ciphering mode) when returning on the old channel are those applied before the RR-CELL CHANGE ORDER message was received.

When the HANDOVER FAILURE message has been received, the network stops T3119.

If a lower layer failure happens while attempting to connect back to the old channels, the standard rules are applied (see clause 3.4.13.2).

On the network side, if timer T3119 elapses before either the mobile station has been recognized on the new cell, or a HANOVER FAILURE message is received on the old channels, then the old channels are released.

On the network side, lower layer failures occurring on the old channels after the sending of the RR-CELL CHANGE ORDER message are ignored.

## 8.5.1 Radio resource management

For the mobile station the following procedures shall apply:

- a) If the message is a CHANNEL RELEASE message, the actions taken shall be the same as specified in clause 3.5 "RR connection release".

# 9 Message functional definitions and contents

This clause defines the structure of the messages of those layer 3 protocols defined in 3GPP TS 04.18. These are standard L3 messages as defined in 3GPP TS 24.007 with the exception of those sent on the SCH, RACH, and the HANOVER ACCESS message.

Each definition given in the present clause includes:

- a) A brief description of the message direction and use, including whether the message has:
  - 1) Local significance, i.e. relevant only on the originating or terminating access;
  - 2) Access significance, i.e. relevant in the originating and terminating access, but not in the network;
  - 3) Dual significance, i.e. relevant in either the originating or terminating access and in the network; or
  - 4) Global significance, i.e. relevant in the originating and terminating access and in the network.
- b) A table listing the information elements known in the message and their order of their appearance in the message. All information elements that may be repeated are explicitly indicated. (V and LV formatted IEs, which compose the imperative part of the message, occur before T, TV, and TLV formatted IEs which compose the non-imperative part of the message, see 3GPP TS 24.007.) In a (maximal) sequence of consecutive information elements with half octet length, the first information element with half octet length occupies bits 1 to 4 of octet N, the second bits 5 to 8 of octet N, the third bits 1 to 4 of octet N+1 etc. Such a sequence always has an even number of elements.

For each information element the table indicates:

- 1) The information element identifier, in hexadecimal notation, if the IE has format T, TV, or TLV. Usually, there is a default IEI for an information element type; default IEIs of different IE types of the same protocol are different. If the IEI has half octet length, it is specified by a notation representing the IEI as a hexadecimal digit followed by a "-" (example: B-).

NOTE: The same IEI may be used for different information element types in different messages of the same protocol.

- 2) The name of the information element (which may give an idea of the semantics of the element). The name of the information element (usually written in italics) followed by "IE" or "information element" is used in 3GPP TS 04.18 as reference to the information element within a message.
- 3) The name of the type of the information element (which indicates the coding of the value part of the IE), and generally, the referenced clause of clause 10 of 3GPP TS 04.18 describing the value part of the information element.
- 4) The presence requirement indication (M, C, or O) for the IE as defined in 3GPP TS 24.007.
- 5) The format of the information element (T, V, TV, LV, TLV) as defined in 3GPP TS 24.007.

- 6) The length of the information element (or permissible range of lengths), in octets, in the message, where "?" means that the maximum length of the IE is only constrained by link layer protocol, and in the case of the Facility IE by possible further conditions specified in 3GPP TS 24.010. This indication is non-normative.
- c) Clauses specifying, where appropriate, conditions for IEs with presence requirement C or O in the relevant message which together with other conditions specified in 3GPP TS 04.18 define when the information elements shall be included or not, what non-presence of such IEs means, and - for IEs with presence requirement C - the static conditions for presence and/or non-presence of the IEs (see 3GPP TS 24.007).

Any information elements specific to 3G, UMTS, UTRAN, CDMA2000, VGCS, VBS, Dual Transfer Mode, Group Receive Mode or Group Transmit Mode shall not be included within any message.

In the case where CSN1 is used to describe the structure of a message, any 3G, UMTS, UTRAN, CDMA2000, VGCS, VBS, Dual Transfer Mode, Group Receive Mode or Group Transmit Mode struct or bit shall not be included within any message, or shall be given a value that indicates that these features are not supported.

## 9.1 Messages for Radio Resources management

Table 9.1.1/3GPP TS 04.18: summarizes the messages for Radio Resources management.

**Table 9.1.1/3GPP TS 04.18: Messages for Radio Resources management**

<b>Channel establishment messages:</b>	<b>Reference</b>
IMMEDIATE ASSIGNMENT	9.1.18
IMMEDIATE ASSIGNMENT EXTENDED	9.1.19
IMMEDIATE ASSIGNMENT REJECT	9.1.20
PACKET ASSIGNMENT	9.1.21f
RR INITIALIZATION REQUEST	9.1.28a
<b>Ciphering messages:</b>	<b>Reference</b>
CIPHERING MODE COMMAND	9.1.9
CIPHERING MODE COMPLETE	9.1.10
<b>Handover messages:</b>	<b>Reference</b>
ASSIGNMENT COMMAND	9.1.2
ASSIGNMENT COMPLETE	9.1.3
ASSIGNMENT FAILURE	9.1.4
PDCH ASSIGNMENT COMMAND	9.1.13a
HANDOVER ACCESS	9.1.14
HANDOVER COMMAND	9.1.15
HANDOVER COMPLETE	9.1.16
HANDOVER FAILURE	9.1.17
RR-CELL CHANGE ORDER	9.1.21e
PHYSICAL INFORMATION	9.1.28
<b>Channel release messages:</b>	<b>Reference</b>
CHANNEL RELEASE	9.1.7
<b>Paging messages:</b>	<b>Reference</b>
PACKET NOTIFICATION	9.1.21g
PAGING REQUEST TYPE 1	9.1.22
PAGING REQUEST TYPE 2	9.1.23
PAGING REQUEST TYPE 3	9.1.24
PAGING RESPONSE	9.1.25
<b>System information messages:</b>	<b>Reference</b>
SYSTEM INFORMATION TYPE 1	9.1.31
SYSTEM INFORMATION TYPE 2	9.1.32
SYSTEM INFORMATION TYPE 2bis	9.1.33
SYSTEM INFORMATION TYPE 2ter	9.1.34
SYSTEM INFORMATION TYPE 3	9.1.35
SYSTEM INFORMATION TYPE 4	9.1.36
SYSTEM INFORMATION TYPE 5	9.1.37
SYSTEM INFORMATION TYPE 5bis	9.1.38
SYSTEM INFORMATION TYPE 5ter	9.1.39
SYSTEM INFORMATION TYPE 6	9.1.40
SYSTEM INFORMATION TYPE 7	9.1.41
SYSTEM INFORMATION TYPE 8	9.1.42

<b>System information messages:</b>	<b>Reference</b>
SYSTEM INFORMATION TYPE 9	9.1.43
SYSTEM INFORMATION TYPE 13	9.1.43a
SYSTEM INFORMATION TYPE 16	9.1.43d
SYSTEM INFORMATION TYPE 17	9.1.43e
SYSTEM INFORMATION TYPE 19	9.1.43f
<b>Measurement specific messages:</b>	<b>Reference</b>
EXTENDED MEASUREMENT ORDER	9.1.51
EXTENDED MEASUREMENT REPORT	9.1.52
MEASUREMENT REPORT	9.1.21
MEASUREMENT INFORMATION	9.1.54
ENHANCED MEASUREMENT REPORT	9.1.55
<b>Miscellaneous messages:</b>	<b>Reference</b>
CHANNEL REQUEST	9.1.8
CLASSMARK CHANGE	9.1.11
CLASSMARK ENQUIRY	9.1.12
FREQUENCY REDEFINITION	9.1.13
MEASUREMENT REPORT	9.1.21
SYNCHRONIZATION CHANNEL INFORMATION	9.1.30
RR STATUS	9.1.29
<b>Application messages:</b>	<b>Reference</b>
APPLICATION INFORMATION	9.1.53

## 9.1.7 Channel release

This message is sent on the main DCCH from the network to the mobile station to initiate deactivation of the dedicated channel used. See table 9.1.7.1/3GPP TS 04.18.

Message type: CHANNEL RELEASE

Significance: dual

Direction: network to mobile station

**Table 9.1.7.1/3GPP TS 04.18: CHANNEL RELEASE message content**

IEI	Information element	Type/Reference	Presence	Format	length
	RR management Protocol Discriminator	Protocol Discriminator 10.2	M	V	1/2
	Skip Indicator	Skip Indicator 10.3.1	M	V	1/2
	Channel Release Message Type	Message Type 10.4	M	V	1
	RR Cause	RR Cause 10.5.2.31	M	V	1
73	BA Range	BA Range 10.5.2.1a	O	TLV	6-?
75	BA List Pref	BA List Pref 10.5.2.1c	O	TLV	3-?

## 9.1.8 Channel request

This message is sent in random mode on the RACH. It does not follow the basic format. The possible formats are presented directly below, without reference to information fields. The order of bit transmission is defined in 3GPP TS 04.04.

The message is only one octet long, coded as shown in figure 9.1.8.1/3GPP TS 04.18 and table 9.1.8.1/3GPP TS 04.18.

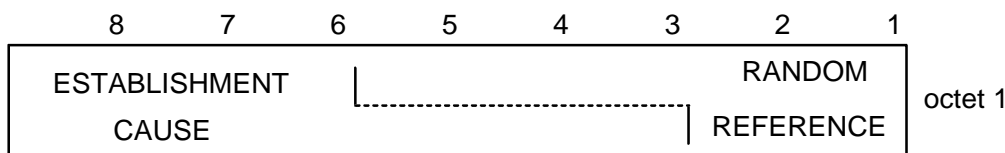

**Figure 9.1.8.1/3GPP TS 04.18: CHANNEL REQUEST message content**

ESTABLISHMENT CAUSE (octet 1)

This information field indicates the reason for requesting the establishment of a connection. This field has a variable length (from 3 bits up to 6 bits).

RANDOM REFERENCE (octet 1)

This is an unformatted field with variable length (from 5 bits down to 2 bits).

The Channel Request message is coded as follows:

(Random Reference field is filled with "x").

**Table 9.1.8.1/3GPP TS 04.18: CHANNEL REQUEST message content**

MS codes According to Establishment cause:	
bits 8 .... 1	
110xxxx	Call re-establishment; TCH/F was in use, or TCH/H was in use but the network does not set NECI bit to 1
011010xx	Call re-establishment; TCH/H was in use and the network sets NECI bit to 1
011011xx	Call re-establishment; TCH/H + TCH/H was in use and the network sets NECI bit to 1
100xxxx 0010xxxx 0011xxxx 0001xxxx	Answer to paging  See table 9.1.8.2/3GPP TS 04.18
111xxxx 1	Originating call and TCH/F is needed, or originating call and the network does not set NECI bit to 1, or procedures that can be completed with a SDCCH and the network does not set NECI bit to 1, see note
0101xxxx	Originating data call from dual-rate mobile station when TCH/H is sufficient and supported by the MS for data calls and the network sets NECI bit to 1. See note 5
000xxxx	Location updating and the network does not set NECI bit to 1
0000xxxx	Location updating and the network sets NECI bit to 1
0001xxxx	Other procedures which can be completed with note 1an SDCCH and the network sets NECI bit to 1
011110xx 01111x0x 01111xx0	One phase packet access with request for single timeslot uplink transmission; one PDCH is needed
01110xxx	Single block packet access; one block period on a PDCH is needed for two phase packet access or other RR signalling purpose
01100111	LMU establishment, see note 2
01100xx0 01100x01 01100011	Reserved for future use  note 2a
01111111	Reserved, see note 2b

NOTE 1: Examples of these procedures are: IMSI detach, Short Message Service (SMS), Location Services.

NOTE 2: If such messages are received by a network, an SDCCH shall be allocated.

NOTE 2a: If such messages are received by a network, an SDCCH may be allocated.

NOTE 2b: This value shall not be used by the mobile station on RACH. If such message is received by the network, it may be ignored. The value is used by the network to answer to a 11 bits EGPRS Packet Channel request.



**Table 9.1.8.2/3GPP TS 04.18: CHANNEL REQUEST message  
(when answering to paging for RR connection establishment)**

MS Capability Paging Indication (note 3)	Full rate only	Dual rate (note 5)	SDCCH only
Any channel	100xxxxx	100xxxxx	100xxxxx
SDCCH	0001xxxx	0001xxxx	0001xxxx
TCH/F	100xxxxx	0010xxxx	0001xxxx
TCH/H or TCH/F	100xxxxx	0011xxxx	0001xxxx

NOTE 3: The Paging Indication is provided by the Channel Needed IE (or the Channel Needed field) associated with the page which triggered the sending of the CHANNEL REQUEST message.

NOTE 4: In some cases the established connection will be used only to allow a default rejection mechanism to take place (typically the mobile station will send a RELEASE COMPLETE message with cause #88 "incompatible destination" as an answer to the incoming SETUP message).

NOTE 5: In this clause, "dual rate capability" means that the MS supports both full rate and half-rate channels at least for the signalling channel mode. In addition, it may support either speech channel mode, or data channel modes, or both on half-rate channels.

### 9.1.11.2 Mobile Station Classmark

This IE shall include for multiband MS the Classmark 2 corresponding to the frequency band in use.

### 9.1.15 Handover command

This message is sent on the main DCCH by the network to the mobile station to change the dedicated channel configuration, timing adjustment needed. See table 9.1.15.1/3GPP TS 04.18.

Message type: HANDOVER COMMAND

Significance: dual

Direction: network to mobile station

**Table 9.1.15.1/3GPP TS 04.18: HANDOVER COMMAND message content**

IEI	Information element	Type/Reference	Presence	Format	length
	RR management Protocol Discriminator	Protocol Discriminator 10.2	M	V	1/2
	Skip Indicator	Skip Indicator 10.3.1	M	V	1/2
	Handover Command Message Type	Message Type 10.4	M	V	1
	Cell Description	Cell description 10.5.2.2	M	V	2
	Description of the first channel, after time	Channel Description 2 10.5.2.5a	M	V	3
	Handover Reference	Handover Reference 10.5.2.15	M	V	1
	Power Command and Access type	Power Command and Access type 10.5.2.28a	M	V	1
D-	Synchronization Indication	Synchronization Indication 10.5.2.39	O	TV	1
02	Frequency Short List, after time	Frequency Short List 10.5.2.14	C	TV	10
05	Frequency List, after time	Frequency List 10.5.2.13	C	TLV	4-131
62	Cell Channel Description	Cell Channel Description 10.5.2.1b	C	TV	17

IEI	Information element	Type/Reference	Presence	Format	length
63	Mode of the First Channel(Channel Set 1))	Channel Mode 10.5.2.6	O	TV	2
11	Mode of Channel Set 2	Channel Mode 10.5.2.6	O	TV	2
13	Mode of Channel Set 3	Channel Mode 10.5.2.6	O	TV	2
14	Mode of Channel Set 4	Channel Mode 10.5.2.6	O	TV	2
15	Mode of Channel Set 5	Channel Mode 10.5.2.6	O	TV	2
16	Mode of Channel Set 6	Channel Mode 10.5.2.6	O	TV	2
17	Mode of Channel Set 7	Channel Mode 10.5.2.6	O	TV	2
18	Mode of Channel Set 8	Channel Mode 10.5.2.6	O	TV	2
64	Description of the Second Channel, after time	Channel Description 10.5.2.5	O	TV	4
66	Mode of the Second Channel	Channel Mode 2 10.5.2.7	O	TV	2
69	Frequency Channel Sequence, after time	Frequency Channel Sequence 10.5.2.12	C	TV	10
72	Mobile Allocation, after time	Mobile Allocation 10.5.2.21	C	TLV	3-10
7C	Starting Time	Starting Time 10.5.2.38	O	TV	3
7B	Real Time Difference	Time Difference 10.5.2.41	C	TLV	3
7D	Timing Advance	Timing Advance 10.5.2.40	C	TV	2
12	Frequency Short List, before time	Frequency Short List 10.5.2.14	C	TV	10
19	Frequency List, before time	Frequency List 10.5.2.13	C	TLV	4-131
1C	Description of the First Channel, before time	Channel Description 2 10.5.2.5a	O	TV	4
1D	Description of the Second Channel, before time	Channel Description 10.5.2.5	O	TV	4
1E	Frequency channel sequence before time	Frequency channel sequence 10.5.2.12	C	TV	10
21	Mobile Allocation, before time	Mobile Allocation 10.5.2.21	C	TLV	3-10
9-	Cipher Mode Setting	Cipher Mode Setting 10.5.2.9	O	TV	1

### 9.1.21e RR-Cell Change Order

This message is sent on the main DCCH by the network to the mobile station to order it to reselect a cell. For a 3G multi-RAT MS the target cell may be a 3G cell. See table 9.1.21e.1/3GPP TS 04.18.

A mobile station that does not support the <<GPRS>> option shall regard this message as an unknown message.

Message type: RR-CELL CHANGE ORDER

Significance: dual

Direction: network to mobile station

**Table 9.1.21e.1/3GPP TS 04.18: RR-CELL CHANGE ORDER message content**

IEI	Information element	Type/Reference	Presence	Format	length
	RR management Protocol Discriminator	Protocol Discriminator 10.2	M	V	1/2
	Skip Indicator	Skip Indicator 10.3.1	M	V	1/2
	RR-Cell Change Order Message Type	Message Type 10.4	M	V	1
	Cell Description	Cell description 10.5.2.2	M	V	2
	NC mode for target cell	NC mode 10.5.2.21c	M	V	1/2
	Spare half octet	Spare half octet 10.5.1.8	M	V	1/2

## 10.1 Overview

Within the RR protocols defined in 3GPP TS 04.18, every message with the exception of the messages sent on the BCCH, downlink CCCH, SCH, RACH, and the HANDOVER ACCESS message, is a standard L3 message as defined in 3GPP TS 24.007. This means that the message consists of the following parts:

- a) protocol discriminator;
- b) transaction identifier;
- c) message type;
- d) other information elements, as required.

This organization is illustrated in the example shown in figure 10.1.1/3GPP TS 04.18.

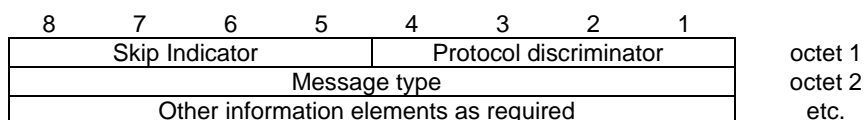
**Figure 10.1.1/3GPP TS 04.18: General message organization example**

Unless specified otherwise in the message descriptions of clause 9, a particular information element shall not be present more than once in a given message.

The term "default" implies that the value defined shall be used in the absence of any assignment, or that this value allows negotiation of alternative values in between the two peer entities.

When a field extends over more than one octet, the order of bit values progressively decreases as the octet number increases. The least significant bit of the field is represented by the lowest numbered bit of the highest numbered octet of the field.

Any 3G, UMTS, UTRAN, CDMA2000, VGCS, VBS, Dual Transfer Mode, Group Receive Mode or Group Transmit Mode fields shall not be included within any information element, or shall be given a value that indicates that these features are not supported.

## 10.4 Message Type

The message type IE and its use are defined in 3GPP TS 24.007. Tables 10.1.1/3GPP TS 04.18 and 10.4.2/3GPP TS 04.18 define the value part of the message type IE used in the Radio Resource management protocol.

Table 10.4.3/3GPP TS 04.18 defines the value part of the message type IE used in the GPRS Transparent Transport protocol.

**Table 10.4.1/3GPP TS 04.18: Message types for Radio Resource management**

8	7	6	5	4	3	2	1	
0	0	1	1	1	-	-	-	Channel establishment messages:
					1	0	0	- RR INITIALIZATION REQUEST
					1	1	1	- IMMEDIATE ASSIGNMENT
					0	0	1	- IMMEDIATE ASSIGNMENT EXTENDED
					0	1	0	- IMMEDIATE ASSIGNMENT REJECT
0	1	0	0	1	0	1	1	- PACKET ASSIGNMENT
0	0	1	1	0	-	-	-	Ciphering messages:
					1	0	1	- CIPHERING MODE COMMAND
					0	1	0	- CIPHERING MODE COMPLETE
0	0	1	0	1	-	-	-	Handover messages:
					1	1	0	- ASSIGNMENT COMMAND
					0	0	1	- ASSIGNMENT COMPLETE
					1	1	1	- ASSIGNMENT FAILURE
					0	1	1	- HANDOVER COMMAND
					1	0	0	- HANDOVER COMPLETE
					0	0	0	- HANDOVER FAILURE
					1	0	1	- PHYSICAL INFORMATION
0	0	0	0	1	0	0	0	- RR-CELL CHANGE ORDER
0	0	1	0	0	0	1	1	- PDCH ASSIGNMENT COMMAND
0	0	0	0	1	-	-	-	Channel release messages:
					1	0	1	- CHANNEL RELEASE
0	0	1	0	0	-	-	-	Paging and Notification messages:
					0	0	1	- PAGING REQUEST TYPE 1
					0	1	0	- PAGING REQUEST TYPE 2
					1	0	0	- PAGING REQUEST TYPE 3
					1	1	1	- PAGING RESPONSE
					1	0	1	- Reserved (see NOTE)
0	0	0	0	1	0	1	1	- Reserved (see NOTE)
0	1	1	0	0	-	-	-	3G Specific messages
0	0	0	1	1	-	-	-	System information messages:
					0	0	0	- SYSTEM INFORMATION TYPE 8
					0	0	1	- SYSTEM INFORMATION TYPE 1
					0	1	0	- SYSTEM INFORMATION TYPE 2
					0	1	1	- SYSTEM INFORMATION TYPE 3
					1	0	0	- SYSTEM INFORMATION TYPE 4
					1	0	1	- SYSTEM INFORMATION TYPE 5
					1	1	0	- SYSTEM INFORMATION TYPE 6
					1	1	1	- SYSTEM INFORMATION TYPE 7
0	0	0	0	0	-	-	-	System information messages:
					0	1	0	- SYSTEM INFORMATION TYPE 2bis
					0	1	1	- SYSTEM INFORMATION TYPE 2ter
					1	0	1	- SYSTEM INFORMATION TYPE 5bis
					1	1	0	- SYSTEM INFORMATION TYPE 5ter
					1	0	0	- SYSTEM INFORMATION TYPE 9
					0	0	0	- SYSTEM INFORMATION TYPE 13
0	0	1	1	1	-	-	-	System information messages:
					1	0	1	- SYSTEM INFORMATION TYPE 16
					1	1	0	- SYSTEM INFORMATION TYPE 17
0	1	0	0	0	-	-	-	System information messages:
					0	0	1	- SYSTEM INFORMATION TYPE 19
0	0	0	1	0	-	-	-	Miscellaneous messages:
					0	1	0	- RR STATUS
					1	0	0	- FREQUENCY REDEFINITION
					1	0	1	- MEASUREMENT REPORT
					1	1	0	- CLASSMARK CHANGE
					0	1	1	- CLASSMARK ENQUIRY
0	0	1	1	0	1	1	0	- EXTENDED MEASUREMENT REPORT
0	0	1	1	0	1	1	1	- EXTENDED MEASUREMENT ORDER
Application messages:								
0	0	1	1	1	0	0	0	- Application Information

Bit 8 is reserved for possible future use as an extension bit, see 3GPP TS 24.007.

NOTE: This value was allocated but never used in earlier phases of the protocol.

**Table 10.4.2/3GPP TS 04.18: Message types for Radio Resource management messages using the RR short protocol discriminator**

5	4	3	2	1	
0	0	0	0	1	Notification/FACCH
0	0	0	1	0	Uplink Free
0	0	1	0	0	Enhanced Measurement Report (uplink)
0	0	1	0	1	Measurement Information (downlink)

**Table 10.4.3/3GPP TS 04.18: Message types for GTP messages**

Message type	Message
8 7 6 5 4 3 2 1	
0 0 0 0 0 0 0 0	GPRS Information

## 10.5 Other information elements

The different formats (V, LV, T, TV, TLV) and the four categories of information elements (type 1, 2, 3, and 4) are defined in 3GPP TS 24.007.

The first octet of an information element in the non-imperative part contains the IEI of the information element. If this octet does not correspond to an IEI known in the message, the receiver shall determine whether this IE is of type 1 or 2 (i.e. it is an information element of one octet length) or an IE of type 4 (i.e. that the next octet is the length indicator indicating the length of the remaining of the information element) (see 3GPP TS 24.007).

This allows the receiver to jump over unknown information elements and to analyse any following information elements.

The information elements which are common for at least two of the three protocols Radio Resources management, Mobility Management, are listed in 3GPP TS 04.08, clause 10.5.1.

The information elements for the protocols Radio Resources management are listed in clause 10.5.2. Default information element identifiers are listed in annex K.

NOTE: Different information elements may have the same default information element identifier if they belong to different protocols.

The descriptions of the information element types in clause 10.5.2 are organized in alphabetical order of the IE types. Each IE type is described in one clause.

The clause may have an introduction:

- possibly explaining the purpose of the IE;
- possibly describing whether the IE belongs to type 1, 2, 3, 4 or 5;
- possibly indicating the length that the information element has if it is either type 5 or if it is used in format TV (type 1 and 3) or TLV (type 4).

A figure of the clause defines the structure of the IE indicating:

- possibly the position and length of the IEI. (However it depends on the message in which the IE occurs whether the IE contains an IEI.);
- the fields the IE value part is composed of;
- possibly the position and length of the length indicator. (However it depends on the IE type whether the IE contains a length indicator or not.);

- possibly octet numbers of the octets that compose the IE (see clause a) below).

Finally, the clause contains tables defining the structure and value range of the fields that compose the IE value part. The order of appearance for information elements in a message is defined in clause 9.

The order of the information elements within the imperative part of messages has been chosen so that information elements with 1/2 octet of content (type 1) go together in succession. The first type 1 information element occupies bits 1 to 4 of octet N, the second bits 5 to 8 of octet N, the third bits 1 to 4 of octet N + 1 etc. If the number of type 1 information elements is odd then bits 5 to 8 of the last octet occupied by these information elements contains a spare half octet IE in format V.

Where the description of information elements in the present document contains bits defined to be "spare bits", these bits shall set to the indicated value (0 or 1) by the sending side, and their value shall be ignored by the receiving side. With few exceptions, spare bits are indicated as being set to "0" in 3GPP TS 04.18.

The following rules apply for the coding of type 4 information elements:

- The octet number of an octet (which is defined in the figure of a clause) consists of a positive integer, possibly of an additional letter, and possibly of an additional asterisk, see clause f). The positive integer identifies one octet or a group of octets.
- Each octet group is a self contained entity. The internal structure of an octet group may be defined in alternative ways.
- An octet group is formed by using some extension mechanism. The preferred extension mechanism is to extend an octet (N) through the next octet(s) (Na, Nb, etc.) by using bit 8 in each octet as an extension bit.

The bit value "0" indicates that the octet group continues through to the next octet. The bit value "1" indicates that this octet is the last octet of the group. If one octet (Nb) is present, the preceding octets (N and Na) shall also be present.

In the format descriptions appearing in clause 10.5.1 to 10.5.4, bit 8 is marked "0/1 ext" if another octet follows. Bit 8 is marked "1 ext" if this is the last octet in the extension domain.

Additional octets may be defined in later versions of the protocols ("1 ext" changed to "0/1 ext") and equipments shall be prepared to receive such additional octets; the contents of these octets shall be ignored. However the length indicated in clauses 9 and 10 only takes into account this version of the protocols.

- In addition to the extension mechanism defined above, an octet (N) may be extended through the next octet(s) (N+1, N+2, etc.) by indications in bits 7-1 (of octet N).
- The mechanisms in c) and d) may be combined.
- Optional octets are marked with asterisks (\*).

### 10.5.2.6 Channel Mode

The *Channel Mode* information element gives information of the mode on coding/decoding and transcoding. The exact mode is determined by the contents of this IE and the channel type.

The *Channel Mode* information element is coded as shown in figure 10.5.2.6.1/3GPP TS 04.18 and table 10.5.2.6.1/3GPP TS 04.18.

The *Channel Mode* is a type 3 information element with 2 octets length.

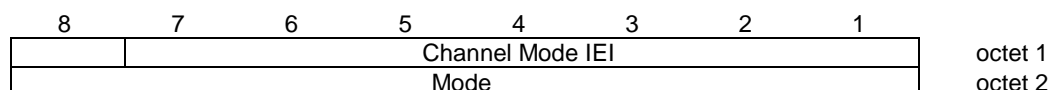

**Figure 10.5.2.6.1/3GPP TS 04.18: *Channel Mode* information element**

**Table 10.5.2.6.1/3GPP TS 04.18: Channel Mode information element**

The mode field is encoded as follows: (octet 2)	
Bits	
8 7 6 5 4 3 2 1	
0 0 0 0 0 0 0 0	signalling only
Other values are reserved for future use.	

### 10.5.2.7 Channel Mode 2

The *Channel Mode 2* information element gives information of the mode of coding/decoding and transcoding.

The *Channel Mode 2* information element is coded as shown in figure 10.5.2.7.1/3GPP TS 04.18 and table 10.5.2.7.1/3GPP TS 04.18.

The *Channel Mode 2* is a type 3 information element with 2 octets length.

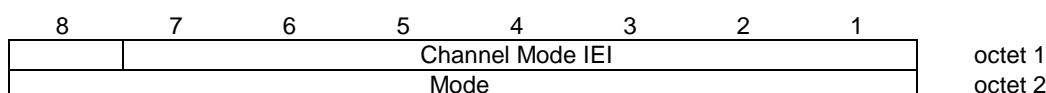
**Figure 10.5.2.7.1/3GPP TS 04.18: Channel Mode 2 information element****Table 10.5.2.7.1/3GPP TS 04.18: Channel Mode 2 information element**

The mode field is encoded as follows: (octet 2)	
Bits	
8 7 6 5 4 3 2 1	
0 0 0 0 0 0 0 0	signalling only
Other values are reserved for future use.	

### 10.5.2.40 Timing Advance

The purpose of the *Timing Advance* information element is to provide the timing advance value.

The *Timing Advance* information element is coded as shown in figure 10.5.2.40.1/3GPP TS 04.18 and table 10.5.2.40.1/3GPP TS 04.18.

The *Timing Advance* is a type 3 information element with 2 octets length.

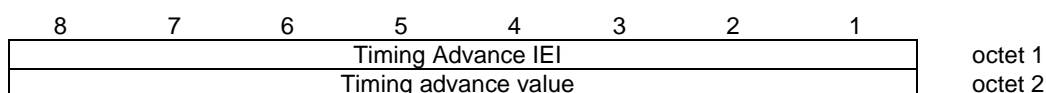
**Figure 10.5.2.40.1/3GPP TS 04.18: Timing Advance information element****Table 10.5.2.40.1/3GPP TS 04.18: Timing Advance information element**

Timing advance value (octet 2)
The coding of the timing advance value field is the binary representation of the timing advance in bit periods; 1 bit period = 48/13 $\mu$ s.
For GSM 400, TETRA 380, TETRA 410 and TETRA 450, the values 0 to 219 are valid TA values. The remaining values 220 to 255 decimal are reserved.
For all the other bands (TETRA 870 included), the values 0 - 63 are valid TA values, and bit 7 and bit 8 are set to spare.

## 10.5.2.47 Suspension Cause

The purpose of the *Suspension Cause* information element is to provide the reason for the GPRS suspension.

The *Suspension Cause* information element is coded as shown in figure 10.5.2.47.1/3GPP TS 04.18 and table 10.5.2.21aa.1/3GPP TS 04.18.

The *Suspension Cause* is a type 3 information element with 2 octets length.

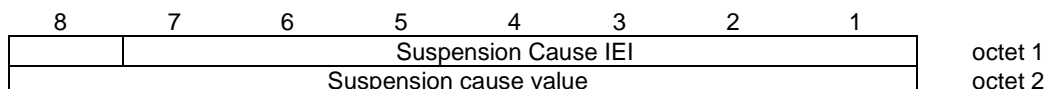

**Figure 10.5.2.47.1/3GPP TS 04.18: *Suspension Cause* information element**

**Table 10.5.2.21aa.1/3GPP TS 04.18: *Suspension Cause* information element**

Suspension cause value (octet 2)	
Bits	
8 7 6 5 4 3 2 1	
0 0 0 0 0 0 0 1	Location Area Update
0 0 0 0 0 0 1 0	MO Short message service (note 1)
0 0 0 0 0 0 1 1	Other procedure which can be completed with an SDCCH
0 0 0 0 0 1 0 0	MO Voice broadcast or group call (note 2)
0 0 0 0 0 1 0 1	Mobile terminating CS connection
0 0 0 0 0 1 1 0	DTM not supported in the cell
Note 1: As an option, cause value 0000 0011 may be used for an MO Short message service	
Note 2: As an option, cause value 0000 0000 may be used for an MO Voice broadcast or group call	
All other cause values shall be treated as 0000 0000	

## 11.1.1 Timers on the mobile station side

**T3122:** This timer is used during random access, after the receipt of an IMMEDIATE ASSIGN REJECT message.

Its value is given by the network in the IMMEDIATE ASSIGN REJECT message.

**T3124:** This timer is used in the seizure procedure during a hand-over, when the two cells are not synchronized.

Its purpose is to detect the lack of answer from the network to the special signal.

Its value is set to 675 ms if the channel type of the channel allocated in the HANDOVER COMMAND is an SDCCH (+ SACCH); otherwise its value is set to 320 ms.

**T3126:** This timer is started either  
after sending the maximum allowed number of CHANNEL REQUEST messages during an immediate assignment procedure.

or

on receipt of an IMMEDIATE ASSIGNMENT REJECT message,

whichever occurs first.

It is stopped at receipt of an IMMEDIATE ASSIGNMENT message, or an IMMEDIATE ASSIGNMENT EXTENDED message.



At its expiry, the immediate assignment procedure is aborted.

The minimum value of this timer is equal to the time taken by T+2S slots of the mobile station's RACH. S and T are defined in clause 3.3.1.2. The maximum value of this timer is 5 seconds.

- T3128:** This timer is started when the mobile station starts the uplink investigation procedure and the uplink is busy.
- It is stopped at receipt of the first UPLINK FREE message.
- At its expiry, the uplink investigation procedure is aborted.
- The value of this timer is set to 1 second.
- T3110:** This timer is used to delay the channel deactivation after the receipt of a (full) CHANNEL RELEASE. Its purpose is to let some time for disconnection of the main signalling link.
- Its value is set to such that the DISC frame is sent twice in case of no answer from the network. (It should be chosen to obtain a good probability of normal termination (i.e. no time out of T3109) of the channel release procedure.)
- T3134** This timer is used in the seizure procedure during an RR network commanded cell change order procedure. Its purpose is to detect the lack of answer from the network or the lack of availability of the target cell.
- Its value is set to 5 seconds.
- T3142:** The timer is used during packet access on CCCH and during packet access while in dedicated mode. It is started after the receipt of an IMMEDIATE ASSIGNMENT REJECT message.
- Its value is given by the network in the IMMEDIATE ASSIGNMENT REJECT message.
- T3146:** This timer is started either:
- after sending the maximum allowed number of CHANNEL REQUEST or EGPRS PACKET CHANNEL REQUEST messages during a packet access procedure;
- or
- on receipt of an IMMEDIATE ASSIGNMENT REJECT message during a packet access procedure,
- whichever occurs first.
- It is stopped at receipt of an IMMEDIATE ASSIGNMENT message, or an IMMEDIATE ASSIGNMENT EXTENDED message.
- At its expiry, the packet access procedure is aborted.
- The minimum value of this timer is equal to the time taken by T+2S slots of the mobile station's RACH. S and T are defined in clause 3.3.1.2. The maximum value of this timer is 5 seconds.
- T3164:** This timer is used during packet access using CCCH. It is started at the receipt of an IMMEDIATE ASSIGNMENT message.
- It is stopped at the transmission of a RLC/MAC block on the assigned temporary block flow, see 3GPP TS 04.60.
- At expire, the mobile station returns to the packet idle mode.
- The value of the timer is 5 seconds.
- T3190:** The timer is used during packet downlink assignment on CCCH. It is started at the receipt of an IMMEDIATE ASSIGNMENT message or of a PDCH ASSIGNMENT COMMAND message when in dedicated mode.

It is stopped at the receipt of a RLC/MAC block on the assigned temporary block flow, see 3GPP TS 04.60.

At expiry, the mobile station returns to the packet idle mode.

The value of the timer is 5 seconds.

**T3204:** This timer is used by a mobile station with non-GSM capabilities. The timer is started after sending the first CHANNEL REQUEST during a packet access procedure. The CHANNEL REQUEST was sent requesting a single block packet access and the purpose of the packet access procedure is to send a PACKET PAUSE message.

It is stopped at the receipt of an IMMEDIATE ASSIGNMENT message granting a single block period on an assigned packet uplink resource.

At expiry, the packet access procedure is aborted.

The value of the timer is 1 second.

## 11.1.2 Timers on the network side

**T3101:** This timer is started when a channel is allocated with an IMMEDIATE ASSIGNMENT message. It is stopped when the MS has correctly seized the channels.

Its value is network dependent.

NOTE 1: It could be higher than the maximum time for a L2 establishment attempt.

**T3103:** This timer is started by the sending of a HANOVER message and is normally stopped when the MS has correctly seized the new channel. Its purpose is to keep the old channels sufficiently long for the MS to be able to return to the old channels, and to release the channels if the MS is lost.

Its value is network dependent.

NOTE 2: It could be higher than the maximum transmission time of the HANOVER COMMAND, plus the value of T3124, plus the maximum duration of an attempt to establish a data link in multiframe mode.

**T3105:** This timer is used for the repetition of the PHYSICAL INFORMATION message during the hand-over procedure.

Its value is network dependent.

NOTE 3: This timer may be set to such a low value that the message is in fact continuously transmitted.

**T3109:** This timer is started when a lower layer failure is detected by the network, when it is not engaged in a RF procedure. It is also used in the channel release procedure.

Its purpose is to release the channels in case of loss of communication.

Its value is network dependent.

NOTE 4: Its value should be large enough to ensure that the MS detects a radio link failure.

**T3111:** This timer is used to delay the channel deactivation after disconnection of the main signalling link. Its purpose is to let some time for possible repetition of the disconnection.

Its value is equal to the value of T3110.

**T3113:** This timer is started when the network has sent a PAGING REQUEST message and is stopped when the network has received the PAGING RESPONSE message.

Its value is network dependent.

NOTE 5: The value could allow for repetitions of the Channel Request message and the requirements associated with T3101.

**T3117:** This timer is started by the sending of a PDCH ASSIGNMENT COMMAND message and is normally stopped when the MS has correctly accessed the target TBF.

Its purpose is to keep the old channel sufficiently long for the MS to be able to return to the old channels, and to release the channels if the MS is lost.

Its value is network dependent.

NOTE 6: It could be higher than the maximum transmission time of the PDCH ASSIGNMENT COMMAND message plus T3132 plus the maximum duration of an attempt to establish a data link in multiframe mode.

**T3119:** This timer is started by the sending of a RR-CELL CHANGE ORDER message and is normally stopped when the MS has correctly accessed the new cell. Its purpose is to keep the old channels sufficiently long for the MS to be able to return to the old channels, and to release the channels if the MS is lost.

Its value is network dependent.

NOTE 7: It could be higher than the maximum transmission time of the RR\_CELL CHANGE ORDER, plus T3134, plus the maximum duration of an attempt to establish a data link in multiframe mode.

**T3141:** This timer is started when a temporary block flow is allocated with an IMMEDIATE ASSIGNMENT message during a packet access procedure. It is stopped when the mobile station has correctly seized the temporary block flow.

Its value is network dependent.

### 11.1.3 Other parameters

**Ny1:** The maximum number of repetitions for the PHYSICAL INFORMATION message during a handover (see clause 3.4.4.2.2). The value is network dependent.

---

## Annex F to GSM 04.18 (informative): GSM specific cause values for radio resource management

This annex is informative.

Cause value = 0 Normal event;

indicates that the channel is released because of a normal event or that an assignment or handover is successfully, and normally, completed.

Cause value = 1 Abnormal release, unspecified;

indicates that the channel is released because of an abnormal event without specifying further reasons.

Cause value = 2 Abnormal release, channel unacceptable;

indicates that the channel type or channel characteristics are not acceptable.

Cause value = 3 Abnormal release, timer expired;

indicates that the release is caused by a timer expiry.

Cause value = 4 Abnormal release, no activity on the radio path;

indicates that some supervisory function has detected that the channel is not active.

Cause value = 5 Pre-emptive release;

indicates that the channel is released in order to be allocated to a call with priority.

Cause value = 8 Handover impossible, timing advance out of range;

indicates that a handover is unsuccessful because the target BTS is beyond the normal range and the target BTS would not accept an out of range timing advance.

Cause value = 9 Channel mode unacceptable

indicates that the MS does not have the capability to handle the requested mode or type of channel.

Cause value = 10 Frequency not implemented

indicates that the MS does not have the capability to operate on (at least one of) the requested frequency(ies).

Cause value = 12 Lower layer failure

indicates that a lower layer failed to establish a connection on the new channel.

Cause value = 65 Call already cleared;

indicates that a handover is unsuccessful because the connection has been released by the network or the remote user.

Cause value = 95 Semantically incorrect message;

see clause H.5.10.

Cause value = 96 Invalid mandatory information;

see clause H.6.1.

Cause value = 97 Message type non-existent or not implemented;

see clause H.6.2.

Cause value = 98 Message type not compatible with protocol state;

see clause H.6.3.

Cause value = 100 Conditional IE error;

see clause H.6.5.

Cause value = 101 No cell allocation available;

indicates that an assignment or handover is unsuccessful because the MS has no current CA.

Cause value = 111 Protocol error unspecified;

see clause H.6.8.

---

## Annex B (normative): Modification to GSM 04.60

This annex details the modified clauses of GSM 04.60 which are applicable to TAPS.

All references to other GSM standards and specifications are to the standards as modified by the present document.

The following clauses have the same numbering as in GSM 04.60.

### 3.1 Vocabulary

The following terms are used in the present document:

**Block period:** A block period is the sequence of four timeslots on a PDCH used to convey one radio block.

**EGPRS:** Enhanced GPRS, enables higher data rates through usage of 8PSK modulation in addition to GMSK. EGPRS also enables Incremental Redundancy operation.

**EGPRS TBF mode:** refers to a TBF utilizing the EGPRS enhancements, e.g. 8PSK modulation and Incremental Redundancy operation.

**GPRS multislot class:** The term GPRS multislot class refers to the different mobile station capabilities to transmit and receive on different combinations of multiple PDCHs. The multislot classes are defined in 3GPP TS 05.02. Note that the mobile station may indicate different multislot classes for circuit mode services and for GPRS (see 3GPP TS 04.08). Different multislot class mobile stations are capable of supporting different medium access modes (see clause 5.2.4).

**GPRS TBF mode:** refers to a TBF not utilizing the EGPRS enhancements, e.g. 8PSK modulation and Incremental Redundancy operation.

**IR:** Incremental redundancy, enables higher data rates through combining information from different transmissions of RLC data blocks when decoding. Also known as Hybrid Type II/III ARQ.

**MCS:** Modulation and Coding Scheme.

**Packet flow context:** Packet Flow Context (PFC) procedures are described in 3GPP TS 23.060. A Packet Flow Identifier (PFI) is used to identify a PFC.

**Packet idle mode:** In packet idle mode, the mobile station is prepared to transfer LLC PDUs on packet data physical channels (see clause 5.3). The mobile station is not allocated any radio resource on a packet data physical channel; it listens to the PBCCH and PCCCH or, if those are not provided by the network, to the BCCH and the CCCH;

**Packet transfer mode:** In packet transfer mode, the mobile station is prepared to transfer LLC PDUs on packet data physical channels (see clause 5.4). The mobile station is allocated radio resource on one or more packet data physical channels for the transfer of LLC PDUs.

**Radio block:** A radio block is the sequence of four normal bursts carrying one RLC/MAC protocol data units (see 3GPP TS 04.04). (The one exception is a radio block occasionally used on PACCH consisting of a sequence of four access bursts, each carrying a repetition of one short RLC/MAC block.)

**Random values:** In a number of places in the present document, it is mentioned that some value must take a "random" value, in a given range, or more generally with some statistical distribution. For such random values refer to 3GPP TS 04.08.

**RLC/MAC block:** A RLC/MAC block is the protocol data unit exchanged between RLC/MAC entities (see clause 10 and 3GPP TS 04.04).

**RLC/MAC control block:** A RLC/MAC control block is the part of a RLC/MAC block carrying a control message between RLC/MAC entities (see clause 10.3).

**RR connection:** An RR connection is a physical connection established between a mobile station and the network to support the upper layers' exchange of information flows. An RR connection is maintained and released by the two peer entities.

**RLC data block:** A RLC data block is the part of a RLC/MAC block carrying user data or upper layers' signalling data (see clause 10.2).

**TBF abort:** The term "abort" as applied to TBF is used when the TBF is abruptly stopped without using the Release of TBF procedures defined in clause 9.

**TBF release:** The term "release" as applied to TBF is used when the TBF is stopped using one of the Release of TBF procedures defined in clause 9.

**Temporary Block Flow (TBF):** A Temporary Block Flow (TBF) is a physical connection used by the two RR peer entities to support the unidirectional transfer of LLC PDUs on packet data physical channels (see clause 5.2.1).

**Timer Expiry:** A started timer has run the time specified.

**Timer Restart:** A timer that may already be running is stopped and then started again to run the time specified.

**Timer Start:** A timer is started to run the time specified.

**Timer Stop:** A started timer is stopped and its value is then undefined.

**Uplink State Flag (USF):** The Uplink State Flag (USF) is used on PDCH channel(s) to allow multiplexing of uplink Radio blocks from different mobile stations (see clause 5.2.3, clause 10 and 3GPP TS 05.02).

## 5.2.4 Medium Access modes

Three medium access modes are supported:

- Dynamic Allocation, characterized by that the mobile station detecting an assigned USF value for each assigned PDCH and block or group of four blocks that it is allowed to transmit on that PDCH (see clause 8.1.1.1);
- Extended Dynamic Allocation characterized by the mobile station detecting an assigned USF value for any assigned PDCH allowing the mobile station to transmit on that PDCH and all higher numbered assigned PDCHs in the same block or group of four blocks (see clause 8.1.1.2);
- Fixed Allocation characterized by fixed allocation of radio blocks and PDCHs in the assignment message without an assigned USF (see clause 8.1.1.3). Fixed Allocation may operate in half duplex mode, characterized by that downlink and uplink TBF are not active at the same time. Half duplex mode is only applicable for multislot classes 19 to 29; and

Either the Dynamic Allocation medium access mode or Fixed Allocation medium access mode shall be supported by all networks that support GPRS. The support of Extended Dynamic Allocation is optional for the network.

The Dynamic Allocation and Fixed Allocation modes shall be supported in all mobile stations. The support of Extended Dynamic Allocation is mandatory for mobile stations of multislot classes 22, 24, 25 and 27. The support of Extended Dynamic Allocation for mobile stations of all other multislot classes are optional and shall be indicated in the MS Radio Access Capability.

The network shall ensure that the medium access mode and the resource allocation used for a mobile station is compatible with the multislot class of the mobile station (the MS classes of multislot capability are defined in 3GPP TS 05.02).

NOTE: Different multislot classes may apply for a certain mobile station in packet transfer mode.

In the case of a downlink transfer, the term medium access mode refers to the measurement time scheduling, for the MS to perform neighbour cell power measurements (see clause 8.1.2.7).

## 5.5 General procedures in packet idle and packet transfer modes

Unless explicitly stated, the requirements in this clause apply only in packet idle mode and in packet transfer mode, not in dedicated mode.

### 5.5.1.1b.1 General

After the release of an RR connection (see 3GPP TS 04.18, *Normal release procedure* and *Abnormal cases*), if the mobile station during the RR connection is unable to monitor the system information broadcast on BCCH or PBCCH, the mobile station shall acquire the system information broadcast in the serving cell. The acquisition of system information shall be performed according to the requirements in clause 5.5.1.2 (PBCCH present in the cell) or clause 5.5.1.3 (PBCCH not present in the cell). The mobile station shall not attempt a packet access or accept a packet downlink assignment before those requirements are fulfilled.

The following exceptions, stated in clauses 5.5.1.1b.2 to 5.5.1.1b.4, may apply.

### 5.5.1.5 Discontinuous reception (DRX)

A mobile station in packet idle mode shall listen to the radio blocks on CCCH or PCCCH as defined in 3GPP TS 05.02. In the *GPRS attach procedure*, defined in 3GPP TS 24.008, the mobile station requests values for the SPLIT\_PG\_CYCLE and NON\_DRX\_TIMER parameters to be applied on CCCH or PCCCH.

NOTE: The support of the SPLIT\_PG\_CYCLE parameter is optional on CCCH, see 3GPP TS 05.02.

The SPLIT\_PG\_CYCLE and NON\_DRX\_TIMER parameters control:

- the occurrence of paging blocks on CCCH or PCCCH belonging to the mobile station (SPLIT\_PG\_CYCLE parameter, see 3GPP TS 05.02) in DRX mode (see 3GPP TS 03.64); and
- the duration of the non-DRX mode period to be applied by the mobile station when it has left the packet transfer mode and then enters the packet idle mode.

There are four cases when the mobile station shall enter a non-DRX mode period.

- 1) At the transition from the packet transfer mode to the packet idle mode, the mobile station shall enter the Transfer non-DRX mode period.

In both cases, the duration of the Transfer non-DRX mode period is determined by value of the NON\_DRX\_TIMER parameter, requested in the *GPRS attach procedure*, and the value of the DRX\_TIMER\_MAX parameter broadcast in the cell. The mobile station may use the minimum value of these two parameters.

If the mobile station receives a new value of the DRX\_TIMER\_MAX parameter during the Transfer non-DRX mode period, the mobile station may wait to apply the new value until the next time the Transfer non-DRX mode period is entered.

- 3) A mobile station operating in NC2 mode shall enter the NC2 non-DRX mode period when it sends an NC measurement report. The duration of this period is defined by the NC\_NON\_DRX\_PERIOD parameter.
- 4) When initiating the MM procedures for *GPRS attach* and *routing area update* defined in 3GPP TS 04.08, the mobile station shall enter the MM non-DRX mode period. This period ends when either of the messages GPRS ATTACH ACCEPT, GPRS ATTACH REJECT, ROUTING AREA UPDATE ACCEPT or ROUTING AREA UPDATE REJECT is received by the mobile station. This period also ends after timeout when waiting for any of these messages.

The non-DRX mode periods defined above run independent of each other and may overlap. The non-DRX mode periods have effect only in packet idle mode. In packet idle mode, the mobile station shall be in non-DRX mode during any of the non-DRX mode periods. Otherwise, the mobile station in packet idle mode may be in DRX mode.

If the mobile station establishes a dedicated connection during any of the non-DRX mode periods, then that period shall continue to run.



### 5.5.1.6 Page mode procedures on PCCCH

The network sends page mode information in all downlink message on PCCCH (and PACCH, see note 1). The page mode information controls possible additional requirements on a mobile station receiving the message.

NOTE: PCCCH, PDTCH and PACCH may be operated in frame stealing mode on the same PDCH. A mobile station in packet idle mode shall consider any RLC/MAC control message received in such a radio block as belonging to PCCCH. A mobile station in packet transfer mode shall consider any RLC/MAC control message received as belonging to PACCH.

A mobile station in packet transfer mode shall not consider the page mode information received in any message that is received on a PDCH.

A mobile station in packet idle mode shall take into account the page mode information in any message received in a radio block on PCCCH corresponding to its paging group. The mobile station shall not take into account the page mode information in a message received in any other radio block than those corresponding to its paging group. The requirements yielded by the page mode information are as follows:

- *normal paging*: no additional requirements;
- *extended paging*: the mobile station is required in addition to receive and analyse the possible message in the third block period on PCCCH where paging may occur (PPCH), following the block corresponding to MS's paging group;
- *paging reorganization*: The mobile station shall receive all messages on the PCCCH regardless of the BS\_PAG\_BLK\_RES setting. It is required to receive all PCCCH messages. When the mobile station receives the next message to its (possibly new) paging group, subsequent action is defined by the page mode information in that message;
- *same as before*: no change of page mode from the previous page mode.

Note that a mobile station takes into account the page mode information only in packet idle mode and only in messages received in a radio block corresponding to its paging group, whatever the currently applied requirements are (normal paging, extended paging or paging reorganization).

When the mobile station selects a new PPCH, the initial page mode in the mobile station shall be set to paging reorganization. If an RLC/MAC block in a paging sub-channel does not contain page mode information, or if it is not received correctly, the default page mode information is *same as before*.

### 5.5.1.7 Frequency Parameters

Frequency parameters may be included in the packet assignment messages (i.e. PACKET DOWNLINK ASSIGNMENT, PACKET UPLINK ASSIGNMENT, and PACKET TIMESLOT RECONFIGURE messages) and define the radio frequency channels or set of radio frequency channels the mobile station is to use during the assigned TBF. The first assignment message, sent to the mobile station when it enters packet transfer mode, shall include the frequency parameters. Subsequent assignment messages, sent to the mobile station during packet transfer mode, may omit the frequency parameters. If a mobile station receives a subsequent assignment message, during packet transfer mode, without the frequency parameters, the mobile station shall continue to use the previously assigned frequency parameters.

The Frequency Parameters information element is defined in clause 12.8. The frequency parameters may use an ARFCN defining a non-hopping radio frequency channel, or use the indirect encoding, direct encoding 1 or direct encoding 2 defining a hopping radio frequency channel.

The indirect encoding defines the assigned set of radio frequency channels by referencing information stored within the mobile station. Such information may be received on PCCCH or BCCH (see clauses 5.5.2.1, 11.2.19, 12.8 and 12.10a), or be received in a previous assignment message using one of the direct encoding options. An MA\_NUMBER identifies which of up to eight stored sets of frequency parameters is to be used. The MA\_NUMBER shall use the following coding:

MA\_NUMBER = 0-13 shall be used to reference a GPRS mobile allocation received in a PSI2 message;

MA\_NUMBER = 14 shall be used to reference a GPRS mobile allocation received in a SI13 or PSI13 message;

MA\_NUMBER = 15 shall be used to reference a GPRS mobile allocation received in a previous assignment message using the direct encoding.

When the indirect encoding is used, the network may include a CHANGE\_MARK\_1 and a CHANGE\_MARK\_2 in the Frequency Parameters information element. The mobile station shall then verify that it is using a set of PBCCH or BCCH information identified by a PSI or SI *change mark* corresponding to one of the CHANGE\_MARK\_1 or 2 parameters, for the decoding of the frequency information. If that is not the case, an abnormal condition occurs.

The direct encoding defines the assigned set of radio frequency channels by using information contained within the assignment message. The direct encoding 1 references the cell allocation or reference frequency lists received on PBCCH for the decoding of this information. The direct encoding 2 is self contained. When the direct encoding 1 or 2 is used, the mobile station shall store the received GPRS mobile allocation for possible later reference in an assignment message using the indirect encoding. Such reference shall be made using the MA\_NUMBER = 15.

NOTE 2: If there is a GPRS mobile allocation associated with MA\_NUMBER = 15, the association shall be kept unchanged if the mobile station receives a packet assignment using the indirect encoding (referencing any value of the MA\_NUMBER), the frequency parameters are not included in the packet assignment (i.e. in packet transfer mode) or the mobile station establishes a dedicated connection.

For the decoding of frequency parameters, the mobile station shall be able to store the following frequency information (see clauses 11.2.19, 12.8 and 12.10a):

- four Reference Frequency Lists received in the PSI2 information and the corresponding RFL\_NUMBERS for identification, each RFL having a contents length of up to 18 octets;
- a Cell Allocation received in the PSI2 information referencing up to four RFLs;
- seven GPRS Mobile Allocations received in the PSI2 or the SI13/PSI13 information and the corresponding MA\_NUMBERS for identification, each GPRS Mobile Allocation information element having a length of up to 12 octets (96 bits); and
- one GPRS mobile allocation received in an assignment message using direct encoding 1 or 2, consisting of either a GPRS Mobile Allocation information element having a length of up to 12 octets (96 bits) or a MA Frequency List having a contents length of up to 18 octets.

The mobile station shall be able to store the frequency information for the PCCCH description corresponding to its own PCCCH\_GROUP (see clause 11.2.19).

If the mobile station supports SMSCB, it shall be able to store the frequency information for the CBCH, to be used in packet idle mode.

The frequency information that the mobile station has stored while camping on a cell shall be deleted when the mobile station reselect cell.

#### 5.5.2.1.3 System information on PACCH (and other logical channels)

The network may broadcast PSI messages on PACCH. In particular, if a mobile station is busy in packet transfer mode and thus unable to receive the relevant blocks on the broadcast channels (PBCCH or BCCH) for a period longer than 15 seconds, the following requirements apply:

- If PBCCH is present in the cell, the network may broadcast the PSI1 message on PACCH such that the mobile station may receive the PSI1 message at least every 15 seconds.
- If PBCCH is not present in the cell, the network may broadcast the PSI13 message on PACCH such that the mobile station may receive the PSI13 messages at least every 15 seconds.

Furthermore, the network may broadcast PSI messages on PCCCH. In particular, the network may send the PSI1 and PSI13 messages on PCCCH to notify mobile stations in packet idle mode about changes in the PBCCH information or changes of the PBCCH channel description.

If the network supports the PACKET PSI STATUS message and this message is received from a mobile station, the network may schedule the missing PSI messages for that mobile station on PACCH.

### 5.6.1 Network Control (NC) measurement reporting

The behaviour of the mobile station is controlled by the parameter NETWORK\_CONTROL\_ORDER broadcast in the PSI5 message on PBCCH, in the SI13 and SI2quater messages on the BCCH and in the PSI13 message on PACCH. Alternatively, the network may send the NETWORK\_CONTROL\_ORDER parameters in a PACKET MEASUREMENT ORDER or in a PACKET CELL CHANGE ORDER message on PCCCH or PACCH to a particular mobile station. The parameter NETWORK\_CONTROL\_ORDER may have one of the values NC0, NC1, NC2 or RESET, see 3GPP TS 05.08.

When in mode NC1 or NC2, the mobile station shall perform the NC measurements as defined in 3GPP TS 05.08. The reporting periods are indicated in the NC\_REPORTING\_PERIOD\_I and NC\_REPORTING\_PERIOD\_T field of the PSI5, the SI2quater, the PACKET CELL CHANGE ORDER or the PACKET MEASUREMENT ORDER message. If NC\_NON\_DRX\_PERIOD, NC\_REPORTING\_PERIOD\_I or NC\_REPORTING\_PERIOD\_T have not been received by the mobile station the default values shall be used. The mobile station shall apply to the timer T3158 either the NC\_REPORTING\_PERIOD\_I when in packet idle mode or the NC\_REPORTING\_PERIOD\_T when in packet transfer mode. The measurement results shall be sent to the network using the procedures specified in clause 7.3 for packet idle mode, and in clause 8.3 for packet transfer mode.

On expiry of timer T3158, the mobile station shall restart timer T3158 with the indicated reporting period, perform the measurements and send either the PACKET MEASUREMENT REPORT message or the PACKET ENHANCED MEASUREMENT REPORT to the network. The condition for sending the PACKET ENHANCED MEASUREMENT REPORT message instead of the PACKET MEASUREMENT REPORT message is based on the REPORT\_TYPE parameter and if the MS has received BSIC information for all cells. For the detailed conditions see clauses 11.2.23, 11.2.4 and 11.2.9b ("Packet System Information Type 5, Packet Cell Change Order, and Packet Measurement Order") and also 3GPP TS 04.18 clause 10.5.2.33b ("SI 2quater Rest Octets").

A mobile station in mode NC1 or NC2 may receive a new indicated reporting period or change packet mode while timer T3158 is active. If the new indicated reporting period is less than the time to expiry of timer T3158, the mobile station shall immediately restart timer T3158 with the new indicated reporting period. Otherwise, the timer T3158 shall continue to run.

When the mobile station leaves the MM Ready state, the timer T3158 shall be stopped and no more measurement reports shall be sent to the network.

A mobile station may reselect a new cell or may be ordered to reselect a new cell with mode NC1 or NC2 while timer T3158 is active. If time to expiry of timer T3158 is greater than the indicated reporting period for the new cell, the mobile station shall immediately restart timer T3158 with the indicated reporting period for the new cell. Otherwise, the timer T3158 shall continue to run.

At cell reselection the NC measurement parameters valid for the mobile station in the new cell (NETWORK\_CONTROL\_ORDER, NC\_NON\_DRX\_PERIOD, NC\_REPORTING\_PERIOD\_I and NC\_REPORTING\_PERIOD\_T) are either:

- brought from the old cell (if received in a PACKET MEASUREMENT ORDER or PACKET CELL CHANGE ORDER message); or
- received in a broadcast PSI5, SI13, PSI13 or SI2quater message in the new cell. If no parameters have been brought from the old cell, and until individual measurement parameters are received in the new cell, the mobile station shall use the broadcast measurement parameters from PSI5 if a PBCCH is allocated or SI2quater in the cell or use the default parameter values.

The default frequency list to be applied in the new cell shall be the BA(GPRS) list of that cell until a new PACKET MEASUREMENT ORDER message is received. The BA(GPRS) list could also have been modified by frequency parameters received in a PACKET\_CELL\_CHANGE\_ORDER message in the old cell.

For (NC) measurement reporting, the Mobile Station shall use PACKET ENHANCED MEASUREMENT REPORT messages instead of PACKET MEASUREMENT REPORT messages if that is indicated by the parameter REPORT\_TYPE and if at least one BSIC is allocated to each frequency in the BA(GPRS) list.

### 5.6.3.3 Deriving the Neighbour Cell list from the GSM Neighbour Cell list

The Neighbour Cell list may contain up to 96 Neighbour Cells. For report with the PACKET ENHANCED MEASUREMENT REPORT message, the Neighbour Cell list is the GSM Neighbour Cell list.

### 5.6.3.5 GPRS Report Priority Descriptions

The GPRS Report Priority information is associated to the Neighbour Cell list and may be received before the corresponding Neighbour Cell list. Each REP\_PRIORITY bit of this field relates to indices of the Neighbour cell list, starting with index 0.

Indices exceeding the value 95 shall be ignored. If there are fewer indices than the number of Neighbour Cells, the value 0 shall be assumed for the missing bits.

In a cell with a PBCCH allocated, Report Priority information may be received from PSI3ter message and associated to the Neighbour Cell list with the same PSI3\_CHANGE\_MARK value, see clause 11.2.23 ("Packet System Information Type 5").

### 5.6.3.6 GPRS Measurement Parameters and GPRS 3G Measurement Parameters

In a cell with a PBCCH allocated, GPRS Measurement Parameters and GPRS 3G Measurement Parameters may be received from PSI3ter and PSI5 messages, see clauses 11.2.21a ("Packet System Information Type 3ter") and 11.2.23 ("Packet System Information Type 5"). When the PSI3\_CHANGE\_MARK or PSI5\_CHANGE\_MARK parameter is changed, the MS shall re-read the corresponding Measurement Parameters and 3G Measurement Parameters.

If different values are received for the same parameter in different instances of a message, only the value in the instance with the highest index shall be used.

## 6.1 Paging procedure for RR connection establishment

The network may initiate the establishment of an RR connection by the paging procedure for RR connection establishment.

The network initiates the paging procedure for RR connection establishment by sending a paging request message on the appropriate paging subchannel on CCCH or PCCCH, addressing the mobile station and indicating RR connection establishment.

The paging subchannels on CCCH and PCCCH are specified in 3GPP TS 05.02 and 3GPP TS 03.13. The paging request message for RR connection establishment is sent on the PCCCH if the mobile station is GPRS attached, PCCCH is present in the cell and the network operates in network mode of operation I (see 3GPP TS 23.060). Otherwise, the paging request message is sent on CCCH.

The network may also page the mobile station for RR connection establishment by sending a paging request message on PACCH if the mobile station is in packet transfer mode.

A mobile station in packet transfer mode is not required to decode the paging subchannels, on neither CCCH nor PCCCH, in the following two cases:

- The mobile station is not capable to handle an RR connection and a TBF simultaneously

### 6.1.3 Paging initiation using PACCH

Paging initiation using PACCH applies when sending a paging request message to a mobile station that is GPRS attached, when the mobile station is in packet transfer mode and the network is able to co-ordinate the paging request with the radio resources allocated for the mobile station on a PDCH. This kind of paging co-ordination shall be provided in network mode of operation I (see 3GPP TS 23.060).

The network shall send the PACKET PAGING REQUEST message to the mobile station on the appropriate PACCH. The message includes the mobile station identification and the channel needed field which defines how the mobile station shall use the establishment cause field in the CHANNEL REQUEST message, as specified in 3GPP TS 04.18.

## 6.1.4 Paging response

When the mobile station responds to a paging request for RR connection establishment, it shall follow the paging response procedures as specified in 3GPP TS 04.18. For that purpose, a mobile station in packet transfer mode or a mobile station that has initiated a packet access procedure may abort any ongoing TBF or the packet access procedure in the following two cases:

- The mobile station is not capable to handle an RR connection and a TBF simultaneously.

## 6.2 Paging procedure for downlink packet transfer

The network may initiate the paging procedure for downlink packet transfer in order to obtain the mobile station cell location required for the downlink packet transfer. The procedure is triggered by a page request from the GMM sublayer on the network side, see 3GPP TS 24.007 and 3GPP TS 24.008. The procedure is initiated by sending a paging request message on the appropriate paging subchannel on CCCH or PCCCH. The paging subchannels on CCCH and PCCCH are specified in 3GPP TS 05.02 and 3GPP TS 03.13.

The paging request message is sent on PCCCH, if PCCCH is present in the cell. Otherwise, the paging request message is sent on CCCH.

## 7.1 TBF establishment initiated by the mobile station on PCCCH

The purpose of the packet access procedure is to establish a TBF to support the transfer of LLC PDUs in the direction from the mobile station to the network. Packet access shall be done on PCCCH, as defined in this clause, if a PCCCH exists. Otherwise, packet access shall be done on CCCH, as defined in 3GPP TS 04.18. The packet access can be done in either one phase (clause 7.1.2) or in two phases (clauses 7.1.2 and 7.1.3).

TBF establishment can also be done on PACCH if a TBF for transfer of LLC PDUs in the direction from the network to the mobile station is already established (see clauses 8.1.1.3 and 8.1.1.3.5). TBF establishment can also be done on PACCH if the mobile station is releasing a TBF for transfer of LLC PDUs in the direction from the mobile station to the network and TBF for transfer of LLC PDUs in the direction from the network to the mobile station is not established (see clauses 9.3.2.4 and 9.3.3.3).

The packet access procedure is initiated by the mobile station. Initiation is triggered by a request from upper layers to transfer a LLC PDU. The request from upper layers specifies throughput, RLC mode, an optional PFI, and a Radio Priority to be associated with the packet transfer or indicates that the packet to be transferred contains signalling.

Upon such a request:

- if access to the network is allowed (clause 7.1.1), the mobile station shall initiate the packet access procedure as defined in clause 7.1.3.1;
- otherwise, the RR sublayer in the mobile station shall reject the request.

If the request from upper layers indicates signalling, the highest Radio Priority shall be used at determination if access to the network is allowed, and the acknowledged RLC mode shall be used.

### 7.1.2.1 Initiation of the packet access procedure

The mobile station shall initiate the packet access procedure by scheduling the sending of PACKET CHANNEL REQUEST messages on the PRACH corresponding to its PCCCH\_GROUP and simultaneously leaving the packet idle mode. The mobile station shall use the last access parameters received on PCCCH. At sending of the first PACKET CHANNEL REQUEST message, the mobile station shall store the value for the Retry (R) bit to be transmitted in all the subsequent MAC headers as "MS sent channel request message once". If a second PACKET CHANNEL REQUEST message is sent, the mobile station shall change the value for the Retry (R) bit to "MS sent channel request message once or more".

While waiting for a response to the PACKET CHANNEL REQUEST message, the mobile station shall monitor the full PCCCH corresponding to its PCCCH\_GROUP. The mobile station shall perform signal strength measurements as they are defined for packet idle mode, see 3GPP TS 05.08.

While monitoring the full PCCCH, the mobile station shall decode any occurrence of the PERSISTENCE\_LEVEL parameter included in a message received on PCCCH. When the mobile station receives the PERSISTENCE\_LEVEL parameter, the value of the PERSISTENCE\_LEVEL parameter shall be taken into account at the next PACKET CHANNEL REQUEST attempt that follows.

A mobile station that is not IMSI attached (GPRS class C mode of operation) shall not respond to any type of PACKET PAGING REQUEST messages during the packet access procedure, only decode the PERSISTENCE\_LEVEL parameter, if that is included in the message.

The PACKET CHANNEL REQUEST messages are sent on PRACH and contain an indication of the type of access and parameters required to indicate the mobile station's demand of radio resource.

There are two formats of the PACKET CHANNEL REQUEST message containing either 8 bit or 11 bit of information. The format to be applied on PRACH is controlled by the parameter ACC\_BURST\_TYPE which is broadcast on PBCCH.

If the mobile station intends to use the TBF to send user data, it shall request two phase access if the requested RLC mode is unacknowledged mode. If the requested RLC mode is acknowledged mode and the amount of data can fit in 8 or less than 8 RLC/MAC blocks, the mobile station shall indicate Short Access as access type. The number of blocks shall be calculated assuming channel coding scheme CS-1 for standard GPRS TBFs, and MCS-1 for EGPRS TBFs. If the requested RLC mode is acknowledged mode and the amount of data to send takes more than 8 RLC/MAC blocks, the mobile station shall request either one phase access or two phase access.

If the purpose of the packet access procedure is to send a Page Response, the mobile station shall indicate 'Page Response' in the PACKET CHANNEL REQUEST message.

If the purpose of the packet access procedure is to send a Cell update (the mobile station was in GMM READY state before the cell reselection) the mobile station shall indicate "Cell Update" in the PACKET CHANNEL REQUEST message.

If the purpose of the packet access procedure is for any other Mobility Management procedure, the mobile station shall indicate "MM Procedure" in the PACKET CHANNEL REQUEST message.

If the purpose of the packet access procedure is to send a Measurement Report, the mobile station shall indicate "Single block without TBF establishment" in the PACKET CHANNEL REQUEST message.

If the purpose of the packet access procedure is to send a PACKET PAUSE message, the mobile station shall indicate "Single block without TBF establishment" in the PACKET CHANNEL REQUEST message. Upon the first attempt to send a PACKET CHANNEL REQUEST message the mobile station shall start timer T3204. If the mobile station receives a PACKET DOWNLINK ASSIGNMENT message before expiry of timer T3204, the mobile station shall ignore the message.

EGPRS capable MSs shall monitor the GPRS Cell Options IE on the BCCH (SI13)/PBCCH (PSI1/PSI13) for the cell's EGPRS capability. In PSI1 (and PSI13) it is indicated if the EGPRS PACKET CHANNEL REQUEST is supported in a cell. If the cell is EGPRS capable and EGPRS PACKET CHANNEL REQUEST is supported in the cell the, EGPRS PACKET CHANNEL REQUEST messages shall be used at one-phase access attempts, two-phase access attempts and short access attempts. If the cell is EGPRS capable and EGPRS PACKET CHANNEL REQUEST messages are not supported in the cell the EGPRS mobile station shall use the PACKET CHANNEL REQUEST message according to parameter ACC\_BURST\_TYPE and shall initiate a two phase access request.

#### 7.1.2.2.4 Packet access reject procedure

The network may, as response to a PACKET CHANNEL REQUEST or EGPRS PACKET CHANNEL REQUEST message, send to the mobile station a PACKET ACCESS REJECT message on any PAGCH block on the same PCCCH on which the channel request message was received. This message contains the request reference with time of reception of the PACKET CHANNEL REQUEST or EGPRS PACKET CHANNEL REQUEST message, and optionally a WAIT\_INDICATION field in the Reject structure of the PACKET ACCESS REJECT message.

On receipt of a PACKET ACCESS REJECT message containing a Reject structure addressed to the mobile station, where the Packet Request Reference in the Reject structure corresponds to one of its 3 last PACKET CHANNEL REQUEST or EGPRS PACKET CHANNEL REQUEST messages:

- The mobile station shall stop timer T3186, stop sending PACKET CHANNEL REQUEST or EGPRS PACKET CHANNEL REQUEST messages, start timer T3172 with the value indicated in the WAIT\_INDICATION field, start timer T3170 if it has not already been started and listen to the downlink PCCCH until timer T3170 expires. During this time, the mobile station shall ignore additional PACKET ACCESS REJECT messages, but on reception of any PACKET UPLINK ASSIGNMENT message corresponding to any other of its 3 last PACKET CHANNEL REQUEST or EGPRS PACKET CHANNEL REQUEST messages the mobile station shall stop timers T3170 and T3172 if running, and follow the procedure defined in clause 7.1.2.2.1.
- If no PACKET UPLINK ASSIGNMENT message is received before expiration of timer T3170, the mobile station shall indicate a packet access failure to upper layer and return to packet idle mode (listening to its paging channel). As an option the mobile station may stop timer T3170, indicate a packet access failure to upper layer and return to packet idle mode as soon as it has received responses from the network on all, or in case more than 3 were sent, the last 3 of its PACKET CHANNEL REQUEST or EGPRS PACKET CHANNEL REQUEST messages.
- If an erroneous PACKET UPLINK ASSIGNMENT message (e.g. the mobile station has been assigned more PDCHs than it supports according to its multislot class) addressed to the mobile station is received before expiration of timer T3170, the mobile station shall stop T3170 and act as stated in clause 7.1.4.
- If the mobile station receives a PACKET DOWNLINK ASSIGNMENT message, it shall stop timer T3170 if running and respond to the PACKET DOWNLINK ASSIGNMENT message (see clause 7.2.1).
- The mobile station is not allowed to make a new attempt for packet access in the same cell until timer T3172 expires, but may attempt packet access in an other cell after successful cell reselection for radio conditions reasons (see 3GPP TS 05.08).
- The value of the WAIT\_INDICATION field (i.e. timer T3172) relates to the cell from which it was received.

## 7.2 TBF establishment initiated by the network on PCCCH

The purpose of network initiated TBF establishment is to establish a TBF to support the transfer of LLC PDUs in the direction from the network to the mobile station. The procedure may be entered when the mobile station is in packet idle mode. Network initiated TBF establishment can also be done on PACCH if a TBF for transfer of LLC PDUs in the direction from the mobile station to the network is already established (clause 8.1.2.5).

### 7.4.1 Cell Change Order procedure initiated on PCCCH

The network may initiate the cell change order procedure by sending a PACKET CELL CHANGE ORDER message in a PCCCH block monitored by the mobile station. No TBF shall be established.

The PACKET CELL CHANGE ORDER message contains:

- The characteristics of the new cell that are necessary to identify it (i.e. BSIC + BCCH frequency);
- the NC measurement parameters valid for the mobile station in the new cell (NETWORK\_CONTROL\_ORDER and optionally: NC\_NON\_DRX\_PERIOD, NC\_REPORTING\_PERIOD\_I and NC\_REPORTING\_PERIOD\_T).

If the mobile station is not involved in an RR connection, upon receipt of the PACKET CELL CHANGE ORDER message, the mobile station shall stop all relevant RLC/MAC timers except for timers related to measurement reporting and start timer T3174. The mobile station shall then switch to the specified new cell and obey the relevant RLC/MAC procedures on this new cell. If the timers related to measurement reporting expire while the reselection procedure has not yet been completed, these timers shall be restarted so that the mobile station resumes the measurement reporting procedures once camped on the new cell. The mobile station shall obey the PACKET CELL CHANGE ORDER irrespective of whether or not the mobile station has any knowledge of the relative synchronization of the target cell to the serving cell.

If the mobile station is involved in an RR connection, the mobile station shall ignore the PACKET CELL CHANGE ORDER message.

The procedure for completion of the cell change order is defined in clause 8.4.1 and abnormal procedures are defined in clause 8.4.2.

## 7.4.2 Cell Change Order procedure initiated on CCCH

The network may initiate the cell change order procedure by sending an IMMEDIATE ASSIGNMENT message for single block assignment in a CCCH block monitored by the mobile station. No TBF shall be established. The single block assignment procedure is specified in 3GPP TS 04.08.

The network shall then send the PACKET CELL CHANGE ORDER message in the assigned downlink block to the mobile station. The PACKET CELL CHANGE ORDER message contains:

- the characteristics of the new cell that are necessary to identify it (i.e. BSIC + BCCH frequency);
- the NC measurement parameters valid for the mobile station in the new cell (NETWORK\_CONTROL\_ORDER and optionally: NC\_NON\_DRX\_PERIOD, NC\_REPORTING\_PERIOD\_I and NC\_REPORTING\_PERIOD\_T).

Upon receipt of the PACKET CELL CHANGE ORDER message, the mobile station shall stop all relevant RLC/MAC timers except for timers related to measurement reporting and start timer T3174. The mobile station shall then switch to the specified new cell and obey the relevant RLC/MAC procedures on this new cell. If the timers related to measurement reporting expire while the reselection procedure has not yet been completed, these timers shall be restarted so that the mobile station resumes the measurement reporting procedures once camped on the new cell. The mobile station shall obey the PACKET CELL CHANGE ORDER irrespective of whether or not the mobile station has any knowledge of the relative synchronization of the target cell to the serving cell.

The procedure for completion of the cell change order is defined in clause 8.4.1 and abnormal procedures are defined in clause 8.4.2.

## 8.0 General

The MAC procedures defined in this clause are applicable in packet transfer mode.

### 8.1.0 Medium access mode

The transfer of RLC data blocks is governed by different principles on both uplink and downlink for each of the defined medium access modes: dynamic allocation, extended dynamic allocation, fixed allocation and exclusive allocation. Fixed allocation may be operated in half duplex mode.

The medium access mode the mobile station is to use, is given by the MAC\_MODE parameter. The MAC\_MODE parameter is included in the downlink assignment (e.g. PACKET DOWNLINK ASSIGNMENT) message. In the uplink assignment (e.g. PACKET UPLINK ASSIGNMENT or PACKET TIMESLOT RECONFIGURE) message, the MAC\_MODE parameter is given indirectly by the presence of either the Dynamic Allocation struct or the Fixed Allocation struct and, respectively, by the EXTENDED\_DYN/AMIC\_ALLOCATION and the HALF\_DUPLEX\_MODE parameters. The value of the MAC\_MODE parameter shall not be changed while the mobile station is in packet transfer mode.

When the conditions for exclusive allocation are fulfilled, the mobile station shall store the value of the MAC\_MODE parameter. The MAC\_MODE parameter has no effect as long as the exclusive allocation is used. When the conditions for exclusive allocation are not fulfilled, the mobile station shall use the medium access mode given by the value of the MAC\_MODE parameter.



### 8.1.1.1 Dynamic allocation uplink RLC data block transfer

This clause specifies mobile station behaviour for dynamic allocation uplink RLC data block transfer while in packet transfer mode.

When the mobile station receives an uplink assignment that does not contain a TBF starting time, the mobile station shall begin monitoring the assigned PDCHs for the assigned USF value for each assigned PDCH within the reaction time defined in TS 100 912. If a TBF starting time information element is present and no uplink TBF is in progress, but a downlink TBF is in progress, the mobile station shall wait until the starting time before beginning to monitor the USFs. While waiting for the starting time, the mobile station shall monitor the assigned PDCHs. If an uplink TBF is already in progress, the mobile station shall continue to use the assigned parameters of the uplink TBF until the TDMA frame number indicated by the TBF starting time occurs, at which time the mobile station shall immediately begin to use the newly assigned uplink TBF parameters. If while waiting for the frame number indicated by the TBF starting time the mobile station receives another uplink assignment, the mobile station shall act upon the most recently received uplink assignment and shall ignore the previous uplink assignment.

If the uplink assignment (e.g. PACKET UPLINK ASSIGNMENT or PACKET TIMESLOT RECONFIGURE) message contains the RLC\_DATA\_BLOCKS\_GRANTED field, the TBF is a close-ended TBF. Otherwise the TBF is open-ended.

During a close-ended TBF the mobile station shall transmit at the most the number of RLC data blocks indicated in the RLC\_DATA\_BLOCKS\_GRANTED field. In the case the access type in Channel Request was "Short Access" (see clause 7.1.2), only the number of RLC data blocks requested in the Channel Request are allowed to be transmitted within the TBF, unless additional resources have been requested and assigned before the countdown procedure has started. Transmission of RLC/MAC control blocks and retransmissions of RLC data blocks do not count toward the limit. When the mobile station nears the end of the close-ended TBF, it shall begin the count down procedure so that it sends the last RLC data block when  $CV = 0$  (see clause 9.3.1). The mobile station and network shall then follow the appropriate procedure for release of TBF defined in clause 9.3.2.3 or clause 9.3.3.3. Upon receipt of a PACKET TBF RELEASE message during a closed-end TBF, the mobile station shall follow the procedure in clause 8.1.1.4. If the number of RLC data blocks granted is not sufficient to empty the mobile station's send buffer, the mobile station shall attempt to establish a new uplink TBF for the transmission of the outstanding LLC frames following the end of the close-ended TBF.

Whenever the mobile station detects an assigned USF value on an assigned PDCH, the mobile station shall transmit either a single RLC/MAC block or a sequence of four RLC/MAC blocks on the same PDCH. The time relation between an uplink block, which the mobile station shall use for transmission, and the occurrence of the USF value is defined in 3GPP TS 05.02. The number of RLC/MAC blocks to transmit is controlled by the USF\_GRANULARITY parameter characterizing the uplink TBF.

When the mobile station transmits an RLC/MAC block to the network, it shall start timer T3180. When the mobile station detects an assigned USF value on an assigned PDCH, the mobile station shall restart timer T3180. If timer T3180 expires, the mobile station shall perform the abnormal release with access retry procedure (see clause 8.7.2).

Whenever the network receives a valid RLC/MAC block from the mobile station, it shall reset counter N3101. The network shall increment counter N3101 for each radio block, allocated to that mobile station, for which no data is received. If  $N3101 = N3101_{max}$ , the network shall stop the scheduling of RLC/MAC blocks from the mobile station and start timer T3169. When T3169 expires, the network may reuse the USF and TFI.

#### 8.1.1.1.2 Resource Reallocation for Uplink

The mobile station and the network are not allowed to change the RLC mode nor TBF mode of an already established TBF during resource reallocation. Change of RLC mode or TBF mode shall be achieved through release of on-going TBF and establishment of a new TBF with the newly requested RLC mode or TBF mode.

During an uplink packet transfer, upper layers may request to transfer another LLC PDU with a different PFI, a different Radio Priority, a different peak throughput class or a different RLC mode than the one which is in transfer. An LLC PDU containing signalling shall be treated as having the highest Radio Priority, and the acknowledged RLC mode shall be used.

If the mobile station has not started the countdown procedure and the new LLC PDU has the same RLC mode as the current uplink TBF and either a higher radio priority or the same radio priority but a higher peak throughput class, the mobile station shall immediately request a resource reallocation for uplink according to the new Radio Priority and peak throughput class of the new LLC PDU by sending a PACKET RESOURCE REQUEST message on the PACCH and starting timer T3168. Then the mobile station shall complete the transmission of the current LLC PDU.

If the new LLC PDU has the same RLC mode as the current uplink TBF and either a lower Radio Priority or the same radio priority but a lower peak throughput class, the mobile station shall first complete the sending of the LLC PDU in transfer. When the sending of LLC PDUs at the higher Radio Priority or the same radio priority but higher peak throughput class stops, without waiting for the acknowledgement from the network if in RLC acknowledged mode, the mobile station shall then perform the request of a resource reallocation for uplink for any remaining LLC PDU(s) by sending a PACKET RESOURCE REQUEST message on the PACCH and start timer T3168.

If the new LLC PDU does not have the same RLC mode as the current uplink TBF but has a higher radio priority, the mobile station shall complete the transmission of the current LLC PDU using the countdown procedure including acknowledgement from the network, if in RLC acknowledged mode. The mobile station shall then release the TBF and establish a new uplink TBF for transmission of the new LLC PDU. When the sending of LLC PDUs with a higher radio priority is completed using the countdown procedure, including acknowledgement from the network if in RLC acknowledged mode, the mobile station shall try to establish an uplink TBF for the transmission of any remaining LLC PDU(s).

If the mobile station has not started the countdown procedure and the new LLC PDU does not have the same PFI as the current uplink TBF, the mobile station shall immediately request a resource reallocation for uplink with the new PFI by sending a PACKET RESOURCE REQUEST message on the PACCH and starting timer T3168. Then the mobile station shall complete the transmission of the current LLC PDU.

On receipt of the PACKET RESOURCE REQUEST the network shall respond by sending a PACKET UPLINK ASSIGNMENT or PACKET TIMESLOT RECONFIGURE or a PACKET ACCESS REJECT message to the mobile station on the downlink PACCH.

After the transmission of the PACKET RESOURCE REQUEST message with the reason for changing PFI, the priority or peak throughput class of an assigned uplink TBF the mobile station shall continue to use the currently assigned uplink TBF assuming that the requested priority or peak throughput class is already assigned to that TBF.

On receipt of a PACKET UPLINK ASSIGNMENT or PACKET TIMESLOT RECONFIGURE message the mobile station shall stop timer T3168 and switch to the assigned PDCHs.

The mobile station is then not allowed to send new PACKET RESOURCE REQUEST messages until either a new packet transfer request is received from the upper layers or when sending of LLC PDU(s) at a lower Radio Priority has to be continued.

On expiry of timer T3168 the mobile station shall retransmit the PACKET RESOURCE REQUEST message unless the PACKET RESOURCE REQUEST has already been transmitted four times in which case the mobile station shall indicate a packet access failure to upper layer and perform an abnormal release without retry (see clause 8.7.1).

If no PACKET UPLINK ASSIGNMENT or PACKET TIMESLOT RECONFIGURE message is received before the mobile station has completed its currently assigned TBFs the mobile station shall stop timer T3168.

The network may at any time during the uplink TBF initiate a change of resources by sending on the downlink PACCH monitored by the MS, an unsolicited PACKET UPLINK ASSIGNMENT or PACKET TIMESLOT RECONFIGURE message to the mobile station. During the reallocation TFI is allowed to be changed.

On receipt of a PACKET ACCESS REJECT message, the mobile station shall stop timer T3168 if running, and abort the uplink TBF and indicate a packet access failure to upper layer. If no downlink TBF exists, the mobile station in packet transfer mode shall return to packet idle mode. The DRX mode procedures shall be applied, as specified in clause 5.5.1.5.

If the PACKET ACCESS REJECT message contains a WAIT\_INDICATION field in a Reject structure addressed to the mobile station, the mobile station shall:

- start timer T3172 and if the mobile station has additional RLC data blocks to transmit, it shall initiate a new uplink TBF establishment, but the mobile station is not allowed to make a new attempt for an uplink TBF establishment in the same cell until timer T3172 expires, it may, however, attempt an uplink TBF establishment in an other cell after successful cell reselection. The mobile station may attempt to enter the dedicated mode in the same cell before timer T3172 has expired. During the time T3172 is running, the mobile station shall ignore all received PACKET PAGING REQUEST messages except paging request to trigger RR connection establishment.

The value of the WAIT\_INDICATION field (i.e. timer T3172) relates to the cell from which it was received.

#### 8.1.1.1.2.1 Abnormal cases

The following abnormal cases apply:

- If the mobile station receives a PACKET UPLINK ASSIGNMENT or PACKET TIMESLOT RECONFIGURE message and detects an invalid Frequency Parameters information element in the message, the mobile station shall perform an abnormal release with system information (see clause 8.7.3), performing a partial acquisition of system information messages containing frequency information.
- If the mobile station receives a PACKET UPLINK ASSIGNMENT or PACKET TIMESLOT RECONFIGURE message specifying frequencies that are not all in one frequency band then the mobile station shall perform an abnormal release with access retry (see clause 8.7.2).
- If the mobile station receives a PACKET UPLINK ASSIGNMENT or PACKET TIMESLOT RECONFIGURE message assigning fixed allocation MAC mode, the mobile station shall perform an abnormal release with access retry (see clause 8.7.2).
- If the information in the PACKET UPLINK ASSIGNMENT does not properly specify an uplink PDCH or violates the mobile station's multislot capabilities, the mobile station shall perform an abnormal release with access retry (see clause 8.7.2).
- If the information in the PACKET TIMESLOT RECONFIGURE does not properly specify an uplink and downlink PDCH or violates the mobile station's multislot capabilities, the mobile station shall perform an abnormal release with access retry (see clause 8.7.2).
- If the mobile station receives a PACKET UPLINK ASSIGNMENT message containing a Frequency Parameters information element specifying a frequency that is in a frequency band not supported by the mobile station then the mobile station shall perform an abnormal release with access retry (see clause 8.7.2).
- If a failure in the PACKET UPLINK ASSIGNMENT or PACKET TIMESLOT RECONFIGURE message is due to any other reason, the mobile station shall perform an abnormal release with access retry (see clause 8.7.2).

NOTE: A PACKET UPLINK ASSIGNMENT or PACKET TIMESLOT RECONFIGURE message received by a multi-band mobile station shall not be considered invalid if it indicates new frequencies that are all in a different frequency band to that of the PDCH(s) on which the assignment was received. The assignment may however be rendered invalid for some other reason.

#### 8.1.1.1.3.1 Abnormal cases

If a failure occurs on the mobile station side before the new TBF has been successfully established, the newly reserved resources are released. The subsequent behaviour of the mobile station depends on the type of failure and previous actions:

- If the information in the PACKET TIMESLOT RECONFIGURE does not properly specify an uplink and downlink PDCH or violates the mobile station's multislot capabilities, the mobile station shall perform an abnormal release with access retry (see clause 8.7.2).
- If uplink and downlink TBFs are not already established and the PACKET TIMESLOT RECONFIGURE message does not include a DOWNLINK\_TFI\_ASSIGNMENT field, then the mobile station shall perform an abnormal release with access retry (see clause 8.7.2).

- If a failure in the PACKET TIMESLOT RECONFIGURE is due to any other reason, the mobile station shall abort the procedure and perform an abnormal release with access retry (see clause 8.7.2).
- If a failure in the PACKET DOWNLINK ASSIGNMENT is due to any reason, the mobile station shall abort the procedure and continue the normal operation of the uplink TBF.

#### 8.1.1.3.2 Reallocation for open-ended TBF

The mobile station and the network are not allowed to change the RLC mode nor TBF mode of an already established TBF during resource reallocation. Change of RLC mode or TBF mode shall be achieved through release of on-going TBF and establishment of a new TBF with the newly requested RLC mode or TBF mode.

During an uplink packet transfer, upper layers may request to transfer another LLC PDU with a different PFI, a different Radio Priority, a different peak throughput class or a different RLC mode than the one which is in transfer. An LLC PDU containing signalling shall be treated as having the highest Radio Priority, and the acknowledged RLC mode shall be used.

If the mobile station has not started the countdown procedure and the new LLC PDU has the same RLC mode as the current uplink TBF and either a higher radio priority or the same radio priority but a higher peak throughput class, the mobile station shall immediately request a resource reallocation for uplink according to the new Radio Priority and peak throughput class of the new LLC PDU by sending a PACKET RESOURCE REQUEST message on the PACCH and starting timer T3168. Then the mobile station shall complete the transmission of the current LLC PDU. If the new LLC PDU has the same RLC mode as the current uplink TBF and either a lower Radio Priority or the same radio priority but a lower peak throughput class, the mobile station shall first complete the sending of the LLC PDU in transfer. When the sending of LLC PDUs at the higher Radio Priority or the same radio priority but higher peak throughput class stops, without waiting for the acknowledgement from the network if in RLC acknowledged mode, the mobile station shall then perform the request of a resource reallocation for uplink for any remaining LLC PDU(s) by sending a PACKET RESOURCE REQUEST message on the PACCH and start timer T3168.

If the new LLC PDU does not have the same RLC mode as the current uplink TBF but has a higher radio priority, the mobile station shall complete the transmission of the current LLC PDU using the countdown procedure including acknowledgement from the network, if in RLC acknowledged mode. The mobile station shall then release the TBF and establish a new uplink TBF for transmission of the new LLC PDU. When the sending of LLC PDUs with a higher radio priority is completed using the countdown procedure, including acknowledgement from the network if in RLC acknowledged mode, the mobile station shall try to establish an uplink TBF for the transmission of any remaining LLC PDU(s).

If the mobile station has not started the countdown procedure and the new LLC PDU does not have the same PFI as the current uplink TBF, the mobile station shall immediately request a resource reallocation for uplink with the new PFI by sending a PACKET RESOURCE REQUEST message on the PACCH and starting timer T3168. Then the mobile station shall complete the transmission of the current LLC PDU.

On receipt of the PACKET RESOURCE REQUEST the network shall respond by sending a PACKET UPLINK ASSIGNMENT or PACKET TIMESLOT RECONFIGURE or a PACKET ACCESS REJECT message to the mobile station on the downlink PACCH.

After the transmission of the PACKET RESOURCE REQUEST message with the reason for changing the priority or peak throughput class of an assigned uplink TBF the mobile station shall continue to use the currently assigned uplink TBF assuming that the requested priority or peak throughput class is already assigned to that TBF.

On receipt of a PACKET UPLINK ASSIGNMENT or PACKET TIMESLOT RECONFIGURE message the mobile station shall stop timer T3168 and switch to the assigned PDCHs.

The mobile station is then not allowed to send new PACKET RESOURCE REQUEST messages until either a new packet transfer request is received from the upper layers or when sending of LLC PDU(s) at a lower Radio Priority has to be continued.

On expiry of timer T3168, the mobile station shall retransmit the PACKET RESOURCE REQUEST message unless the PACKET RESOURCE REQUEST message has already been transmitted four times. In that case, the mobile station shall indicate packet access failure to upper layer and perform an abnormal release without retry (see clause 8.7.1).

If no PACKET UPLINK ASSIGNMENT or PACKET TIMESLOT RECONFIGURE message is received before the mobile station has completed its currently assigned TBFs the mobile station shall stop timer T3168.

The network may at any time during the uplink TBF initiate a change of resources by sending on the downlink PACCH monitored by the MS, an unsolicited PACKET UPLINK ASSIGNMENT or PACKET TIMESLOT RECONFIGURE, or an uplink resource reassignment in a PACKET UPLINK ACK/N/ACK message to the mobile station. During the reallocation TFI is allowed to be changed.

On receipt of a PACKET ACCESS REJECT message, the mobile station shall stop timer T3168 if running, abort the uplink TBF and indicate a packet access failure to upper layer. If no downlink TBF exists, the mobile station in packet transfer mode shall return to packet idle mode. The DRX mode procedures shall be applied, as specified in clause 5.5.1.5.

If the PACKET ACCESS REJECT message contains a WAIT\_INDICATION field in a Reject structure addressed to the mobile station, the mobile station shall:

- start timer T3172 and if the mobile station has additional RLC data blocks to transmit, it shall initiate a new uplink TBF establishment, but the mobile station is not allowed to make a new attempt for an uplink TBF establishment in the same cell until timer T3172 expires, it may, however, attempt an uplink TBF establishment in an other cell after successful cell reselection. The mobile station may attempt to enter the dedicated mode in the same cell before timer T3172 has expired. During the time T3172 is running, the mobile station shall ignore all received PACKET PAGING REQUEST messages except paging request to trigger RR connection establishment.

The value of the WAIT\_INDICATION field (i.e. timer T3172) relates to the cell from which it was received.

#### 8.1.1.3.2.5 Abnormal Cases

The following abnormal cases apply:

- If the mobile station receives an assignment message containing an allocation other than a fixed allocation, the mobile station shall perform an abnormal release with access retry (see clause 8.7.2).
- If the information in the PACKET UPLINK ASSIGNMENT does not properly specify an uplink PDCH or violates the mobile station's multislot capabilities, the mobile station shall perform an abnormal release with access retry (see clause 8.7.2).
- If the information in the PACKET TIMESLOT RECONFIGURE does not properly specify an uplink and downlink PDCH or violates the mobile station's multislot capabilities, the mobile station shall perform an abnormal release with access retry (see clause 8.7.2).
- If a mobile station receives a PACKET UPLINK ASSIGNMENT or PACKET TIMESLOT RECONFIGURE message and detects an invalid Frequency Parameters information element in the message, the mobile station shall perform an abnormal release with system information (see clause 8.7.3), performing a partial acquisition of system information messages containing frequency information.
- if the mobile station receives a PACKET UPLINK ASSIGNMENT or PACKET TIMESLOT RECONFIGURE message specifying frequencies that are not all in one band then the mobile station shall perform an abnormal release with access retry (see clause 8.7.2).
- If a failure in the PACKET UPLINK ASSIGNMENT or PACKET TIMESLOT RECONFIGURE message is due to any other reason, the mobile station shall perform an abnormal release with access retry (see clause 8.7.2).

NOTE: A PACKET UPLINK ASSIGNMENT message received by a multi-band mobile station shall not be considered invalid if it indicates new frequencies that are all in a different frequency band to that of the PDCH(s) on which the assignment was received. The assignment may however be rendered invalid for some other reason.

#### 8.1.1.3.5.1 Abnormal cases

If a failure occurs on the mobile station side before the new TBF has been successfully established, the newly reserved resources are released. The subsequent behaviour of the mobile station depends on the type of failure and previous actions:

- If the information available in the mobile station, after the reception of a PACKET DOWNLINK ASSIGNMENT message does not satisfactorily define a PDCH, the mobile station shall ignore the PACKET DOWNLINK ASSIGNMENT message.
- If a failure in the PACKET DOWNLINK ASSIGNMENT is due to any other reason, then the mobile station shall ignore the PACKET DOWNLINK ASSIGNMENT.
- If the information in the PACKET TIMESLOT RECONFIGURE does not properly specify an uplink and downlink PDCH or violates the mobile station's multislots capabilities, the mobile station shall perform an abnormal release with access retry (see clause 8.7.2).
- If the PACKET TIMESLOT RECONFIGURE does not include a DOWNLINK\_TFI\_ASSIGNMENT field, then the mobile station shall perform an abnormal release with access retry (see clause 8.7.2).
- If a failure in the PACKET TIMESLOT RECONFIGURE is due to any other reason, then the mobile station shall perform an abnormal release with access retry (see clause 8.7.2).
- If the mobile station is not operating the uplink TBF in half duplex mode and receives a PACKET DOWNLINK ASSIGNMENT message containing different frequency parameters than are currently in effect for the uplink TBF, the mobile station shall ignore the PACKET DOWNLINK ASSIGNMENT message and continue normal operation of the uplink TBF.
- If the mobile station is operating the uplink TBF in half duplex mode and receives a PACKET DOWNLINK ASSIGNMENT message that does not indicate half duplex mode, the mobile station shall ignore the PACKET DOWNLINK ASSIGNMENT.
- If the failure is due to any other reason, the mobile station shall abort the procedure and perform an abnormal release with access retry (see clause 8.7.2).

#### 8.1.1.5 Abnormal cases

The following abnormal cases apply:

- If the mobile station receives a PACKET UPLINK ASSIGNMENT, PACKET TIMESLOT RECONFIGURE, or a PACKET DOWNLINK ASSIGNMENT message with an invalid Frequency Parameters information element, the mobile station shall perform an abnormal release with system information (see clause 8.7.3), performing a partial acquisition of system information messages containing frequency information.
- If the mobile station receives a PACKET UPLINK ASSIGNMENT, PACKET TIMESLOT RECONFIGURE, or a PACKET DOWNLINK ASSIGNMENT message specifying frequencies that are not all in one band then the mobile shall perform an abnormal release with access retry (see clause 8.7.2).
- If the mobile station receives a PACKET UPLINK ASSIGNMENT, PACKET TIMESLOT RECONFIGURE, or a PACKET UPLINK ACK/N/ACK with an ALLOCATION\_BITMAP whose TBF starting time has elapsed, the mobile station shall use whatever portion of the fixed allocation remains. If none of the fixed allocation remains, the mobile station shall ignore the message.
- If the mobile station receives a PACKET UPLINK ACK/N/ACK with missing mandatory fields, the MS shall perform an abnormal release with access retry (see clause 8.7.2).
- If the mobile station has not started or has not completed the countdown procedure and it receives a Packet Uplink Ack/Nack with the Final Ack Indicator set, it shall perform an abnormal release with access retry (see clause 8.7.2).

NOTE: A PACKET UPLINK ASSIGNMENT, PACKET TIMESLOT RECONFIGURE, or a PACKET DOWNLINK ASSIGNMENT message sent to a multi-band mobile station shall not be considered invalid if it indicates new frequencies that are all in a different frequency band to that of the ARFCN of the serving cell.

### 8.1.2.1 Downlink RLC data block transfer

This clause specifies mobile station behaviour for downlink RLC data block transfer while in packet transfer mode.

Upon reception of a downlink assignment that does not contain a TBF starting time the mobile station shall start timer T3190 and within the reaction time defined in TS 100 912, it shall attempt to decode every downlink block on its assigned PDCHs. If the PACKET DOWNLINK ASSIGNMENT or PACKET TIMESLOT RECONFIGURE message contains a TBF starting time information element and there is no downlink TBF in progress, but an uplink TBF is in progress, the mobile station shall remain on the assigned PDCHs until the TDMA frame number indicated by the TBF starting time, at which time the mobile station shall start timer T3190 and immediately begin decoding the assigned downlink PDCH(s). If the PACKET DOWNLINK ASSIGNMENT or PACKET TIMESLOT RECONFIGURE message contains a TBF starting time and there is a downlink TBF already in progress, the mobile station shall continue to use the parameters of the downlink TBF in progress until the TDMA frame number indicated in the TBF starting time occurs, at which time the mobile station shall immediately begin to use the new assigned downlink TBF parameters. If while waiting for the frame number indicated by the TBF starting time the mobile station receives another downlink assignment, the mobile station shall act upon the most recently received downlink assignment and shall ignore the previous downlink assignment. Procedures on receipt of a PACKET DOWNLINK ASSIGNMENT message while no TBF is in progress are specified in clause 7.2.1.1.

If the mobile station receives a valid RLC data block addressed to itself, the mobile station shall restart timer T3190. If timer T3190 expires, the mobile station shall perform an abnormal release without retry (see clause 8.7.1).

Upon receipt of a PACKET TBF RELEASE referring to the downlink TBF, the mobile station shall follow the procedure in clause 8.1.2.8.

#### 8.1.2.1.1 Abnormal cases

If a failure occurs on the mobile station side before the new TBF has been successfully established, the newly reserved resources are released. The subsequent behaviour of the mobile station depends on the type of failure and previous actions:

- If a mobile station receives a PACKET DOWNLINK ASSIGNMENT or PACKET TIMESLOT RECONFIGURE message and detects an invalid Frequency Parameters information element in the message, it shall perform an abnormal release with system information (see clause 8.7.3), performing a partial acquisition of system information messages containing frequency information.
- If the information in the PACKET TIMESLOT RECONFIGURE does not properly specify an uplink and downlink PDCH or violates the mobile station's multislot capabilities, the mobile station shall perform an abnormal release with access retry (see clause 8.7.2).
- If the PACKET TIMESLOT RECONFIGURE does not include a DOWNLINK\_TFI\_ASSIGNMENT field, then the mobile station shall perform an abnormal release with access retry (see clause 8.7.2).
- If a failure in the PACKET TIMESLOT RECONFIGURE is due to any other reason, the mobile station shall abort the procedure and perform an abnormal release with access retry (see clause 8.7.2).
- If the information available in the mobile station, after the reception of a PACKET DOWNLINK ASSIGNMENT message does not satisfactorily define a PDCH, the mobile station shall ignore the PACKET DOWNLINK ASSIGNMENT message.
- If the mobile station is not operating an uplink TBF in half duplex mode and receives a PACKET DOWNLINK ASSIGNMENT message containing different frequency parameters than are currently in effect for the uplink TBF, the mobile station shall ignore the PACKET DOWNLINK ASSIGNMENT message and continue normal operation of the uplink TBF.
- If the mobile station is operating an uplink TBF in half duplex mode and receives a PACKET DOWNLINK ASSIGNMENT message that does not indicate half duplex mode, the mobile station shall ignore the PACKET DOWNLINK ASSIGNMENT.
- If a failure in the PACKET DOWNLINK ASSIGNMENT is due to any other reason, the mobile station shall abort the procedure. If an uplink TBF exists, the mobile station shall continue the normal operation of the uplink TBF. If an uplink TBF does not exist, the mobile station shall perform an abnormal release without retry (see clause 8.7.1).

#### 8.1.2.4.1 Abnormal cases

These abnormal cases apply during establishment of downlink TBF after downlink TBF release (see clause 8.1.2.4a).

If a failure occurs on the mobile station side before the new TBF has been successfully established, the newly reserved resources are released. The subsequent behaviour of the mobile station depends on the type of failure and previous actions:

- If a mobile station receives a PACKET DOWNLINK ASSIGNMENT or PACKET TIMESLOT RECONFIGURE message and detects an invalid Frequency Parameters information element in the message, the mobile station shall perform an abnormal release with system information (see clause 8.7.3), performing a partial acquisition of system information messages containing frequency information.
- If the information in the PACKET TIMESLOT RECONFIGURE does not properly specify an uplink and downlink PDCH or violates the mobile station's multislot capabilities, the mobile station shall perform an abnormal release with access retry (see clause 8.7.2).
- If a failure in the PACKET TIMESLOT RECONFIGURE is due to any other reason, the mobile station shall abort the procedure and perform an abnormal release with access retry (see clause 8.7.2).
- If the information available in the mobile station, after the reception of a PACKET DOWNLINK ASSIGNMENT message does not satisfactorily define a PDCH, the mobile station shall ignore the PACKET DOWNLINK ASSIGNMENT message.
- If the mobile station is not operating the uplink TBF in half duplex mode and receives a PACKET DOWNLINK ASSIGNMENT message containing different frequency parameters than are currently in effect for the uplink TBF, the mobile station shall ignore the PACKET DOWNLINK ASSIGNMENT message and continue normal operation of the uplink TBF.
- If the mobile station is operating the uplink TBF in half duplex mode and receives a PACKET DOWNLINK ASSIGNMENT message that does not indicate half duplex mode, the mobile station shall ignore the PACKET DOWNLINK ASSIGNMENT.
- If a failure in the PACKET DOWNLINK ASSIGNMENT is due to any other reason, the mobile station shall abort the procedure. If an uplink TBF exists, the mobile station shall continue the normal operation of the uplink TBF. If an uplink TBF does not exist, the mobile station shall perform an abnormal release without retry (see clause 8.7.1).

#### 8.1.2.5.1 Abnormal cases

If a failure occurs on the mobile station side before the new TBF has been successfully established, the newly reserved resources are released. The subsequent behaviour of the mobile station depends on the type of failure and previous actions.

- If the information in the PACKET UPLINK ASSIGNMENT violates the mobile station's multislot capabilities, the mobile station shall perform an abnormal release with access retry (see clause 8.7.2).
- If the mobile station is not operating the downlink TBF in half duplex mode and receives a PACKET UPLINK ASSIGNMENT message containing different frequency parameters than are currently in effect for the downlink TBF, the mobile station shall ignore the PACKET UPLINK ASSIGNMENT message, continue normal operation of the downlink TBF, and reinitiate the access unless it has already been attempted 4 times, in which case, the mobile station shall perform the abnormal release with access retry (see clause 8.7.2).
- If the mobile station is operating the downlink TBF in half duplex mode and receives a PACKET UPLINK ASSIGNMENT message that does not indicate half duplex mode, the mobile station shall ignore the PACKET UPLINK ASSIGNMENT.
- If a failure in the PACKET UPLINK ASSIGNMENT is due to any other reason, the mobile station shall abort the procedure and continue the reception of downlink PDUs.
- If the information in the PACKET TIMESLOT RECONFIGURE does not properly specify a set of uplink and downlink PDCH(s) or violates the mobile station's multislot capabilities, the mobile station shall perform an abnormal release with access retry (see clause 8.7.2).



- If the PACKET TIMESLOT RECONFIGURE does not include a correct UPLINK\_TFI\_ASSIGNMENT field, then the mobile station shall perform an abnormal release with access retry (see clause 8.7.2).
- If a failure in the PACKET TIMESLOT RECONFIGURE is due to any other reason, the mobile station shall perform an abnormal release with access retry (see clause 8.7.2).
- If the failure is due to any other reason, the mobile station shall abort the procedure and perform an abnormal release with access retry (see clause 8.7.2).

#### 8.1.2.8 Network initiated abnormal release of downlink TBF

The network may initiate immediate abnormal release of a downlink TBF by transmitting a PACKET TBF RELEASE message to the mobile station on the PACCH.

The mobile station shall immediately stop monitoring its assigned downlink PDCHs. If a valid RRBP field is received as part of the PACKET TBF RELEASE message, the mobile station shall transmit a PACKET CONTROL ACKNOWLEDGMENT message in the uplink radio block specified.

If there is no on-going uplink TBF, the mobile station in packet transfer mode shall enter packet idle mode. The DRX mode procedures shall be applied, as specified in clause 5.5.1.5.

## 8.4 Network controlled cell reselection procedure

A cell reselection is made controlled either by the mobile station or by the network.

When the cell reselection is made controlled by the mobile station, the mobile station shall apply the cell reselection procedure defined in clause 5.5.1.1.

When a cell reselection is initiated by the network for an individual mobile station, the cell change order procedure is started by sending a PACKET CELL CHANGE ORDER message to the mobile station on the PCCCH or PACCH.

The PACKET CELL CHANGE ORDER message contains:

- the characteristics of the new cell that are necessary to identify it (i.e. BSIC + BCCH frequency);
- the NC measurement parameters valid for the mobile station in the new cell (NETWORK\_CONTROL\_ORDER and optionally: NC\_NON\_DRX\_PERIOD, NC\_REPORTING\_PERIOD\_I and NC\_REPORTING\_PERIOD\_T);
- the IMMEDIATE\_REL parameter.

Upon receipt of the PACKET CELL CHANGE ORDER message the mobile station shall start timer T3174 and apply the cell reselection procedure defined in clause 5.5.1.1. with the additional rule that an immediate abort of operation in the old cell may be required by the network through the IMMEDIATE\_REL field, except for the acknowledgement, by means of a PACKET CONTROL ACKNOWLEDGEMENT message, of a valid RRBP field possibly included in the PACKET CELL CHANGE ORDER message. The mobile station shall obey the PACKET CELL CHANGE ORDER irrespective of whether or not the mobile station has any knowledge of the relative synchronization of the target cell to the serving cell.

If the timers related to measurement reporting expire while the reselection procedure has not yet been completed, these timers shall be restarted so that the mobile station resumes the measurement reporting procedures once camped on the new cell.

### 8.4.2 Abnormal cases

On the mobile station side, if the PACKET CELL CHANGE ORDER message instructs the mobile station to use a frequency that it is not capable of using, then the mobile station shall return a PACKET CELL CHANGE FAILURE message with cause "frequency not implemented".

If the PACKET CELL CHANGE ORDER message is received by a mobile performing an anonymous access, the mobile station shall return a PACKET CELL CHANGE FAILURE message with the cause "anonymous access".

If the PACKET CELL CHANGE ORDER message is received while the mobile is in GMM Standby state, the mobile shall return a PACKET CELL CHANGE FAILURE:

- if the GMM Ready timer has a negotiated value equal to zero, with the cause set to "Forced to the Standby state";
- if the GMM Ready timer has a negotiated value not equal to zero, with the cause set to "GMM Standby state".

The message PACKET CELL CHANGE FAILURE is sent on the PACCH if an uplink TBF exist.

If no TBF exists, the mobile station shall initiate a random access, with access type "single block without TBF establishment", and then transmit the PACKET CELL CHANGE FAILURE message on the single block.

If a TBF exist, the mobile station shall remain on the current PDCH(s).

On the network side, lower layer failures occurring on the old channels after the sending of the PACKET CELL CHANGE ORDER message are ignored.

### 8.7.1 Abnormal release without retry

The mobile station shall abort all TBFs in progress and report an RLC/MAC failure to upper layers. The mobile station in packet transfer mode shall return to packet idle mode. The DRX mode procedures shall be applied as specified in clause 5.5.1.5.

In case the mobile station fails to establish a new uplink TBF, the mobile station shall report an RLC/MAC failure to upper layers. The DRX mode procedures shall be applied, as specified in clause 5.5.1.5.

### 8.7.2 Abnormal release with access retry

The mobile station shall abort all TBFs in progress. The mobile station in packet transfer mode shall return to packet idle mode and initiate the establishment of a new uplink TBF, using the procedures on CCCH or PCCCH, as defined in clause 7.1.

In case the mobile station fails to establish a new uplink TBF, the mobile station shall report an RLC/MAC failure to upper layers. The DRX mode procedures shall be applied, as specified in clause 5.5.1.5.

### 9.3.2.4 Release of uplink Temporary Block Flow

The mobile station initiates release of the uplink TBF by beginning the countdown process (see clause 9.3.1). When the mobile station has sent the RLC data block with  $CV = 0$  and there are no elements in the  $V(B)$  array set to the value Nacked, it shall start timer T3182. The mobile station shall continue to send RLC data blocks on each assigned uplink data block, according to the algorithm defined in clause 9.1.3.

If the network has received all RLC data blocks when it detects the end of the TBF (i.e. when  $CV=0$  and  $V(Q) = V(R)$ ), it shall send the PACKET UPLINK ACK/N/ACK message with the Final Ack Indicator bit set to '1', include a valid RRBP field in the RLC/MAC control block header and clear counter N3103. The network may use the TBF Est field in the PACKET UPLINK ACK/N/ACK message to allow the mobile station to request the establishment of new TBF.

If the network has not received all of the RLC data blocks when it detects the end of the TBF, it shall send a PACKET UPLINK ACK/N/ACK message to the mobile station and if necessary allocate sufficient uplink resources for the mobile station to retransmit the required RLC data blocks.

Upon reception of a PACKET UPLINK ACK/N/ACK message the mobile station shall stop timer T3182.

If the PACKET UPLINK ACK/N/ACK message has the Final Ack Indicator bit set to '1' and the following conditions are fulfilled: TBF Est field is set to '1'; the mobile station has new data to transmit; the mobile station has no ongoing downlink TBF; and the mobile station is not assigned to operate in half duplex mode or the mobile station is assigned to operate in half duplex mode and the mobile station has not received downlink assignment during the countdown or while timer T3182 was running, the mobile station shall release the TBF and may request the establishment of new TBF using one of the following procedures:

- If Control Ack Type parameter in System Information indicates acknowledgement is access burst, the mobile station shall transmit the PACKET CONTROL ACKNOWLEDGEMENT message with the Ctrl Ack bits set to '00'. The mobile station shall start timer T3168 and continue to monitor the PDCH used for transmitting the PACKET CONTROL ACKNOWLEDGEMENT message. The mobile station shall stop timer T3168 upon reception of the PACKET UPLINK ASSIGNMENT message including Single Block Allocation structure or the PACKET ACCESS REJECT message. The mobile station shall use the same procedures as are used for TBF establishment using two phase access described in clause 7.1.3 starting from the point where the mobile station receives the PACKET UPLINK ASSIGNMENT message including Single Block Allocation structure or the PACKET ACCESS REJECT message.
- If Control Ack Type parameter in System Information indicates acknowledgement is RLC/MAC control block, the mobile station shall transmit the PACKET RESOURCE REQUEST message and start timer T3168. The mobile station shall use the same procedures as are used for TBF establishment using two phase access described in clause 7.1.3 starting from the point where the mobile station transmits the PACKET RESOURCE REQUEST message.

If the PACKET UPLINK ACK/N/ACK message has the Final Ack Indicator bit set to '1' and the mobile station does not initiate the establishment of a new uplink TBF according to one of the procedures described above, the mobile station shall transmit the PACKET CONTROL ACKNOWLEDGEMENT message and release the TBF. If the mobile station is operating in half duplex mode and received a downlink assignment during the countdown or while timer T3182 was running, it shall then act on the downlink assignment. If there is no ongoing downlink TBF, the mobile station in packet transfer mode shall return to packet idle mode. The DRX mode procedures shall be applied as specified in clause 5.5.1.5.

If the PACKET UPLINK ACK/N/ACK message requests retransmission of RLC data blocks, the mobile station shall if necessary wait for allocation of uplink resources and then retransmit the RLC data blocks requested. The mobile station shall then start timer T3182 and wait for a PACKET UPLINK ACK/N/ACK message as above.

If the mobile station is operating in half duplex mode and received a downlink assignment during the countdown or while timer T3182 was running, and then T3182 expires, the mobile station shall then immediately act on the downlink assignment and then request an uplink TBF via the PACKET DOWNLINK ACK/N/ACK. Otherwise, if timer T3182 expires the mobile station shall perform an abnormal release with access retry (see clause 8.7.2).

When the network receives the PACKET CONTROL ACKNOWLEDGEMENT message or the PACKET RESOURCE REQUEST message in the radio block indicated by the RRBp field, it may reuse the TFI and USF resources.

If the network receives the PACKET CONTROL ACKNOWLEDGEMENT message with Ctrl Ack bits set to '00' or the PACKET RESOURCE REQUEST message in the radio block indicated by the RRBp field and the network has set the TBF Est field to '1' in the PACKET UPLINK ACK/N/ACK message, the network shall follow one of the following procedures:

- In case the mobile station requested the establishment of new TBF with the PACKET CONTROL ACKNOWLEDGEMENT message, the network shall respond to the mobile station with the PACKET UPLINK ASSIGNMENT message including Single Block Allocation structure or the PACKET ACCESS REJECT message on the same PDCH as the mobile station has sent the PACKET CONTROL ACKNOWLEDGEMENT message. TLLI shall be used to identify the mobile station. The network shall use the same procedures as are used for TBF establishment using two phase access described in clause 7.3.1 starting from the point where the network transmits the PACKET UPLINK ASSIGNMENT message including Single Block Allocation structure or the PACKET ACCESS REJECT message.
- In case the mobile station requested the establishment of new TBF with the PACKET RESOURCE REQUEST message, the network shall use the same procedures as are used for TBF establishment using two phase access described in clause 7.3.1 starting from the point where the network has received the PACKET RESOURCE REQUEST message. TLLI shall be used to identify the mobile station.

If the network does not receive the PACKET CONTROL ACKNOWLEDGEMENT message or the PACKET RESOURCE REQUEST message in the radio block indicated by the RRBp field, it shall increment counter N3103 and retransmit the PACKET UPLINK ACK/N/ACK message. If counter N3103 exceeds its limit, the network shall start timer T3169. When timer T3169 expires the network may reuse the TFI and USF resources.

### 9.3.2.6 Release of downlink Temporary Block Flow

The network initiates release of a downlink TBF by sending an RLC data block with the Final Block Indicator (FBI) set to the value '1' and with a valid RRBp field. The RLC data block sent must have the highest BSN' (see clause 9.3.1) of the downlink TBF. The network shall start timer T3191. While timer T3191 is running the network may retransmit the RLC data block with the FBI bit set to the value '1'.

If the mobile station receives an RLC data block with the FBI bit set the value '1' and with a valid RRBp field, the mobile station shall transmit a PACKET DOWNLINK ACK/N/ACK message in the specified uplink block. The mobile station shall continue to monitor all assigned PDCHs.

Whenever the mobile station receives an RLC data block with a valid RRBp and the mobile station has received all RLC data blocks of the TBF, the mobile station shall send the PACKET DOWNLINK ACK/N/ACK message with the Final Ack Indicator bit set to '1', stop timer T3190 and start or restart timer T3192.

If the mobile station receives more than one RLC data block with the FBI set to '1', it shall accept the data from only the first one of these blocks.

If the network receives a PACKET DOWNLINK ACK/N/ACK message before timer T3191 expires, and if retransmissions are required, then the network stops timer T3191 and retransmits necessary RLC data blocks according to the ARQ protocol before re-initiating the release of the downlink TBF. The FBI is set to '1' only if the RLC data block with the highest BSN' of the TBF is retransmitted. If no retransmission is required, the network shall stop timer T3191 and start timer T3193. When T3193 expires the network shall release the TBF.

If timer T3191 expires, then the network shall release the TBF.

If the network has received the PACKET DOWNLINK ACK/N/ACK message with the Final Ack Indicator bit set to '1' and has new data to transmit for the mobile station, the network may establish a new downlink TBF for the mobile station by sending the PACKET DOWNLINK ASSIGNMENT or PACKET TIMESLOT RECONFIGURE message with the Control Ack bit set to '1' on PACCH. In case the network establishes a new downlink TBF for the mobile station, the network shall stop timer T3193.

If the mobile station, after sending the PACKET DOWNLINK ACK/N/ACK message with the Final Ack Indicator bit set to '1', receives a PACKET DOWNLINK ASSIGNMENT or PACKET TIMESLOT RECONFIGURE message with the Control Ack bit set to '1' while timer T3192 is running, the mobile station shall stop timer T3192, consider the previous downlink TBF released and act upon the new assignment.

When timer T3192 expires the mobile station shall release the downlink TBF. If the mobile station is operating in half duplex mode and received an uplink assignment during the TBF release procedure, the mobile station shall then immediately act upon the uplink assignment. If there is no ongoing uplink TBF, the mobile station in packet transfer mode shall return to packet idle mode. The DRX mode procedures shall be applied, as specified in clause 5.5.1.5.

### 9.3.3.3 Release of uplink Temporary Block Flow

The mobile station initiates release of the uplink TBF by beginning the countdown process (see clause 9.3.1). It indicates the end of the TBF by setting the CV value to 0 and starts timer T3182.

If the mobile station is operating in half duplex mode and receives a downlink assignment during the countdown, it shall continue the countdown until complete and then immediately act on the downlink assignment.

When the network detects the end of the TBF (i.e. when CV=0) it shall send a PACKET UPLINK ACK/N/ACK message with the Final Ack Indicator bit set to '1', include a valid RRBp field in the RLC/MAC control block header and clear counter N3103. The network may use the TBF Est field in the PACKET UPLINK ACK/N/ACK message to allow the mobile station to request the establishment of new TBF.

In case the network receives multiple blocks with CV=0, only the first needs to be acknowledged with PACKET UPLINK ACK/N/ACK message.

Upon reception of a PACKET UPLINK ACK/N/ACK message the mobile station shall stop timer T3182.

If the PACKET UPLINK ACK/N/ACK message has the Final Ack Indicator bit set to '1' and the mobile station does not initiate the establishment of a new uplink TBF according to one of the procedures described below, the mobile station shall transmit the PACKET CONTROL ACKNOWLEDGEMENT message and release the TBF. If the mobile station is operating in half duplex mode and received a downlink assignment during the countdown or while timer T3182 was running, it shall then act on the downlink assignment. If there is no ongoing downlink TBF, the mobile station in packet transfer mode shall enter packet idle mode. The DRX mode procedures shall be applied, as specified in clause 5.5.1.5.

If the PACKET UPLINK ACK/N/ACK message has the Final Ack Indicator bit set to '1' and the following conditions are fulfilled: TBF Est field is set to '1'; the mobile station has new data to transmit; the mobile station has no ongoing downlink TBF; and the mobile station is not operating in half duplex mode or the mobile station is operating in half duplex mode and the mobile station has not received downlink assignment during the countdown, the mobile station shall release the TBF and may request the establishment of new TBF using one of the following procedures:

- If Control Ack Type parameter in System Information indicates acknowledgement is access burst, the mobile station shall transmit the PACKET CONTROL ACKNOWLEDGEMENT message with the Ctrl Ack bits set to '00'. The mobile station shall start timer T3168 and continue to monitor the PDCH used for transmitting the PACKET CONTROL ACKNOWLEDGEMENT message. The mobile station shall stop timer T3168 upon reception of the PACKET UPLINK ASSIGNMENT message including Single Block Allocation structure or the PACKET ACCESS REJECT message. The mobile station shall use the same procedures as are used for TBF establishment using two phase access described in clause 7.1.3 starting from the point where the mobile station receives the PACKET UPLINK ASSIGNMENT message including Single Block Allocation structure or the PACKET ACCESS REJECT message.
- If Control Ack Type parameter in System Information indicates acknowledgement is RLC/MAC control block, the mobile station shall transmit the PACKET RESOURCE REQUEST message and start timer T3168. The mobile station shall use the same procedures as are used for TBF establishment using two phase access described in clause 7.1.3 starting from the point where the mobile station transmits the PACKET RESOURCE REQUEST message.

If the PACKET UPLINK ACK/N/ACK message does not have the Final Ack Indicator bit set to '1', the mobile station shall repeat sending the last block with CV=0, until a PACKET UPLINK ACK/N/ACK message with Final Ack Indicator bit set to '1' is received. Upon each retransmission of the last block with CV=0, the mobile station shall restart timer T3182. The block with CV=0 shall not be retransmitted more than four times. If the medium access mode is dynamic allocation, the repetitions are transmitted when the mobile station is scheduled USFs. If fixed allocation is used, the mobile station shall transmit the repetitions within any remaining allocated uplink blocks. If timer T3182 expires the mobile station shall release the TBF as if a PACKET UPLINK ACK/N/ACK message was received.

When the network receives the PACKET CONTROL ACKNOWLEDGEMENT message or the PACKET RESOURCE REQUEST message in the radio block indicated by the RRBp field, it may reuse the TFI and USF resources.

If the network receives the PACKET CONTROL ACKNOWLEDGEMENT message with Ctrl Ack bits set to '00' or the PACKET RESOURCE REQUEST message in the radio block indicated by the RRBp field and the network has set the TBF Est field to '1' in the PACKET UPLINK ACK/N/ACK message, the network shall follow one of the following procedures:

- In case the mobile station requested the establishment of new TBF with the PACKET CONTROL ACKNOWLEDGEMENT message, the network shall respond to the mobile station with the PACKET UPLINK ASSIGNMENT message including Single Block Allocation structure or the PACKET ACCESS REJECT message on the same PDCH as the mobile station has sent the PACKET CONTROL ACKNOWLEDGEMENT message. TLLI shall be used to identify the mobile station. The network shall use the same procedures as are used for TBF establishment using two phase access described in clause 7.3.1 starting from the point where the network transmits the PACKET UPLINK ASSIGNMENT message including Single Block Allocation structure or the PACKET ACCESS REJECT message.
- In case the mobile station requested the establishment of new TBF with the PACKET RESOURCE REQUEST message, the network shall use the same procedures as are used for TBF establishment using two phase access described in clause 7.3.1 starting from the point where the network has received the PACKET RESOURCE REQUEST message. TLLI shall be used to identify the mobile station.

If the network does not receive the PACKET CONTROL ACKNOWLEDGEMENT message or the PACKET RESOURCE REQUEST message in the radio block indicated by the RRBp field, it shall increment counter N3103 and retransmit the PACKET UPLINK ACK/N/ACK message. If counter N3103 exceeds its limit, the network shall start timer T3169. When timer T3169 expires the network may reuse the TFI and USF resources.

### 9.3.3.5 Release of downlink Temporary Block Flow

The network initiates release of a downlink TBF by sending an RLC data block with the Final Block Indicator (FBI) set to the value '1' and with a valid RRBP field. The RLC data block sent must have the highest BSN' (see clause 9.3.1) of the downlink TBF. The network shall start timer T3191. The network may retransmit the last block with FBI set to the value '1' and with a valid RRBP field. For each retransmission the timer T3191 is restarted.

For each RLC data block with the FBI bit set to '1' and with a valid RRBP field, the mobile station shall transmit the PACKET CONTROL ACKNOWLEDGEMENT message in the uplink block specified by the RRBP field. The mobile station shall continue to read the assigned downlink PDCHs until the block period pointed to by the RRBP. If the mobile station receives more than one RLC data block with the FBI bit set to '1' and with valid RRBP fields that point the same uplink block period, the mobile station shall transmit the PACKET CONTROL ACKNOWLEDGEMENT message only once. The mobile station shall then stop timer T3190, start timer T3192 and continue to monitor all assigned downlink PDCHs. If the mobile station then receives a subsequent RLC data block with a valid RRBP and the FBI bit set to '1', the mobile station shall retransmit the PACKET CONTROL ACKNOWLEDGEMENT message and restart timer T3192.

If the mobile station receives more than one RLC data block with the FBI set to '1', it shall accept the data from only the first one of these blocks.

If the network receives the PACKET CONTROL ACKNOWLEDGEMENT message before timer T3191 expires, the network shall stop timer T3191 and start timer T3193. When T3193 expires the network shall release the TBF.

If timer T3191 expires, the network shall release the TBF.

If the network has received the PACKET CONTROL ACKNOWLEDGEMENT message and has new data to transmit for the mobile station, the network may establish a new downlink TBF for the mobile station by sending the PACKET DOWNLINK ASSIGNMENT or PACKET TIMESLOT RECONFIGURE message with the Control Ack bit set to '1' on PACCH. In case the network establishes a new downlink TBF for the mobile station, the network shall stop timer T3193.

If the mobile station, after sending the PACKET CONTROL ACKNOWLEDGEMENT message, receives a PACKET DOWNLINK ASSIGNMENT or PACKET TIMESLOT RECONFIGURE message with the Control Ack bit set to '1' while timer T3192 is running, the mobile station shall stop timer T3192, consider the previous downlink TBF released and act upon the new assignment.

When timer T3192 expires the mobile station shall release the downlink TBF. If the mobile station is operating in half duplex mode and received an uplink assignment during the TBF release procedure, the mobile station shall then immediately act upon the assignment. If there is no ongoing uplink TBF the mobile station in packet transfer mode shall enter packet idle mode. The DRX mode procedures shall be applied as specified in clause 5.5.1.5.

### 9.4.2 Abnormal release with cell reselection

If access in another cell is allowed (i.e. RANDOM\_ACCESS\_RETRY = 1) and the mobile station is not in dedicated mode of a circuit switched connection, the mobile station shall abort all TBFs in progress and return to packet idle mode. The mobile station shall perform an abnormal cell reselection (see 3GPP TS 05.08) and initiate the establishment of an uplink TBF, using the procedures on CCCH or PCCCH as defined in clause 7.1 on the new cell. The mobile station shall not reselect back to the original cell for T\_RESEL seconds if another suitable cell is available.

If the abnormal cell reselection is abandoned (see 3GPP TS 05.08), the mobile station shall report an RLC/MAC failure to upper layers. If the mobile station remains in the cell where the abnormal release occurred, the DRX mode procedures shall be applied, as specified in clause 5.5.1.5.

If access in another cell is not allowed (i.e. RANDOM\_ACCESS\_RETRY = 0), the mobile station shall perform an abnormal release without retry, defined in clause 8.7.1.

The parameters RANDOM\_ACCESS\_RETRY and T\_RESEL (default value 5 seconds) are broadcast in PSI 3.

### 10.4.10a Power Reduction (PR) field

If downlink power control is not used, the MS shall ignore the PR field.

## 11.2 RLC/MAC control messages

Any information elements specific to 3G, UMTS, UTRAN, CDMA2000, VGCS, VBS, Dual Transfer Mode, Group Receive Mode or Group Transmit Mode shall not be included within any message.

In the case where CSN1 is used to describe the structure of a message, any 3G, UMTS, UTRAN, CDMA2000, VGCS, VBS, Dual Transfer Mode, Group Receive Mode or Group Transmit Mode struct or bit shall not be included within any message, or shall be given a value that indicates that these features are not supported.

Table 1 summarizes the RLC/MAC control messages. For each control message, the message type shall be a fixed number of bits from the beginning of the message.

**Table 1: RLC/MAC control messages**

<b>Uplink TBF establishment messages:</b>	<b>Reference</b>
Packet Access Reject	11.2.1
Packet Channel Request	11.2.5
EGPRS Packet Channel Request	11.2.5a
Packet Queuing Notification	11.2.15
Packet Resource Request	11.2.16
Packet Uplink Assignment	11.2.29
Additional MS Radio Access Capabilities	11.2.32
<b>Downlink TBF establishment messages:</b>	<b>Reference</b>
Packet Downlink Assignment	11.2.7
<b>TBF release messages:</b>	<b>Reference</b>
Packet TBF Release	11.2.26
<b>Paging messages:</b>	<b>Reference</b>
Packet Paging Request	11.2.10
<b>RLC messages:</b>	<b>Reference</b>
Packet Downlink Ack/Nack	11.2.6
EGPRS Packet Downlink Ack/Nack	11.2.6a
Packet Uplink Ack/Nack	11.2.28
<b>System information messages:</b>	<b>Reference</b>
Packet System Information Type 1	11.2.18
Packet System Information Type 2	11.2.19
Packet System Information Type 3	11.2.20
Packet System Information Type 3 bis	11.2.21
Packet System Information Type 3 ter	11.2.21a
Packet System Information Type 4	11.2.22
Packet System Information Type 5	11.2.23
Packet System Information Type 6	11.2.23a
Packet System Information Type 7	11.2.23b
Packet System Information Type 8	11.2.24
Packet System Information Type 13	11.2.25
<b>Miscellaneous messages:</b>	<b>Reference</b>
Packet Control Acknowledgement	11.2.2
Packet Cell Change Failure	11.2.3
Packet Cell Change Order	11.2.4
Packet Downlink Dummy Control Block	11.2.8
Packet Uplink Dummy Control Block	11.2.8b
Packet Measurement Report	11.2.9
Packet Measurement Order	11.2.9b
Packet Mobile TBF Status	11.2.9c
Packet Enhanced Measurement Report	11.2.9d
Packet PDCH Release	11.2.11
Packet Polling Request	11.2.12
Packet Power Control/Timing Advance	11.2.13
Packet PRACH Parameters	11.2.14
Packet PSI Status	11.2.17
Spare	11.2.24
Spare	11.2.27
Spare	11.2.30
Packet Pause	11.2.30a
Packet Timeslot Reconfigure	11.2.31

## 12.1 Overview

Information elements used within the context of only one RLC/MAC control message are defined in clause 11. All other information elements are defined within the present clause. Any 3G, UMTS, UTRAN, CDMA2000, VGCS, VBS, Dual Transfer Mode, Group Receive Mode or Group Transmit Mode fields shall not be included within any information element, or shall be given a value that indicates that these features are not supported.



---

## Annex C (normative): Modification to GSM 05.01

This annex details the modified clauses of GSM 05.01 which are applicable to TAPS.

All references to other GSM standards and specifications are to the standards as modified by the present document.

Where the following channel names appear in diagrams, they should be treated as if they had been deleted.

- CTSARCH
- CTSAGCH
- CTSBCH
- CTSPCH
- TCH/EF
- TCH/AFS
- TCH/AHS
- TCH/HS
- TCH/EFS
- TCH/AF
- TCH/AH
- TCH/FS
- E-TCH/F followed by a data rate
- TCH/F followed by a data rate
- TCH/H followed by a data rate
- HSCSD
- ECSD
- NCH

The following clauses have the same numbering as in GSM 05.01.

---

## 2 Set of channels

The radio subsystem provides a certain number of logical channels that can be separated into two categories according to GSM 04.03, 3GPP TS 03.64 and 3GPP TS 03.52:

- 1) The traffic channels (TCH): only those intended to carry data are included. The following types of traffic channels are defined: cell broadcast (CBCH), full rate packet data (PDTCH/F) and half rate packet data (PDTCH/H) traffic channels. For the purpose of this series of technical specifications, the following traffic channels are distinguished:
  - cell broadcast channel (CBCH);
  - full rate packet data traffic channel (PDTCH/F);
  - half rate packet data traffic channel (PDTCH/H).

All channels are bi-directional unless otherwise stated. Unidirectional downlink full rate channels, TCH/FD are defined as the downlink part of the corresponding TCH/F. Unidirectional uplink full rate channels are FFS.

The allocated uplink and downlink PDTCH are used independently of each other. Dependent allocation of uplink and downlink is possible.

Multislot configurations for packet switched connections are defined as multiple (1 up to 8) PDTCH/Us and one PACCH for one mobile originated communication, or multiple (1 up to 8) PDTCH/Ds and one PACCH for one mobile terminated communication respectively, allocated to the same MS. In this context allocation refers to the list of PDCH that may dynamically carry the PDTCHs for that specific MS. The PACCH shall be mapped onto one PDCH carrying one PDTCH/U or PDTCH/D. That PDCH shall be indicated in the resource allocation message (see 3GPP TS 04.60).

- 2) The signalling channels: these can be sub-divided into (P)BCCH ((packet) broadcast control channel), (P)CCCH ((packet) common control channel), SDCCH (stand-alone dedicated control channel), (P)ACCH ((packet) associated control channel), and packet timing advance control channel (PTCCH). An associated control channel is always allocated in conjunction with, either a TCH, or an SDCCH. A packet associated control channel is always allocated in conjunction to one or multiple PDTCH, concurrently assigned to one MS. For the purpose of this series of technical specifications, the following signalling channels are distinguished:
- stand-alone dedicated control channel, four of them mapped on the same basic physical channel as the CCCH (SDCCH/4);
  - stand-alone dedicated control channel, eight of them mapped on a separate basic physical channel (SDCCH/8);
  - full rate fast associated control channel (FACCH/F);
  - enhanced circuit switched full rate fast associated control channel (E-FACCH/F);
  - half rate fast associated control channel (FACCH/H);
  - slow, TCH/F or E-TCH/F associated, control channel (SACCH/TF);
  - slow, TCH/H associated, control channel (SACCH/TH);
  - slow, TCH/F or E-TCH/F associated, control channel for multislot configurations (SACCH/M);
  - slow, SDCCH/4 associated, control channel (SACCH/C4);
  - slow, SDCCH/8 associated, control channel (SACCH/C8);
  - packet associated control channel (PACCH);
  - packet timing advance control channel (PTCCH);
  - broadcast control channel (BCCH);
  - packet broadcast control channel (PBCCH);
  - random access channel (i.e. uplink CCCH) (RACH);
  - packet random access channel (i.e. uplink PCCCH) (PRACH);
  - paging channel (part of downlink CCCH) (PCH);
  - packet paging channel (part of downlink PCCCH) (PPCH);
  - access grant channel (part of downlink CCCH) (AGCH);
  - packet access grant channel (part of downlink PCCCH) (PAGCH);
  - packet notification channel (part of downlink PCCCH) (PNCH).

All associated control channels have the same direction (bi-directional or unidirectional) as the channels they are associated to. The unidirectional SACCH/MD is defined as the downlink part of SACCH/M.

When there is no need to distinguish between different sub-categories of the same logical channel, only the generic name will be used, meaning also all the sub-categories (SACCH will mean all categories of SACCHs, SACCH/T will mean both the slow, TCH associated, control channels, etc.).

The logical channels mentioned above are mapped on physical channels that are described in this set of technical specifications. The different physical channels provide for the transmission of information pertaining to higher layers according to a block structure.

### 3 Reference configuration

For the purpose of elaborating the physical layer specification, a reference configuration of the transmission chain is used as shown in annex A. This reference configuration also indicates which parts are dealt with in details in which technical specification. It shall be noted that only the transmission part is specified, the receiver being specified only via the overall performance requirements. With reference to this configuration, the technical specifications in the 05 series address the following functional units:

- 3GPP TS 05.02: burst building, and burst multiplexing;
- 3GPP TS 05.03: coding, reordering and partitioning, and interleaving;
- 3GPP TS 05.04: differential encoding, and modulation;
- 3GPP TS 05.05: transmitter, antenna, and receiver (overall performance).

This reference configuration defines also a number of points of vocabulary in relation to the name of bits at different levels in the configuration. It must be outlined, in the case of the encrypted bits, that they are named only with respect to their position after the encryption unit, and not to the fact that they pertain to a flow of information that is actually encrypted.

### 4 The block structures

The different block structures are described in more detail in 3GPP TS 05.03 (Channel coding). A summarized description appears in table 1, in terms of net bit rate, length and recurrence of blocks.

**Table 1: Channel block structures**

Type of channel	net bit rate (kbit/s)	block length (bits)	block recurrence (ms)
PDTCH/F (CS-1)	9,05	181	-
PDTCH/F (CS-2)	13,4	268	-
PDTCH/F (CS-3)	15,6	312	-
PDTCH/F (CS-4)	21,4	428	-
PDTCH/H (CS-1)	4,525	181	-
PDTCH/H (CS-2)	6,7	268	-
PDTCH/H (CS-3)	7,8	312	-
PDTCH/H (CS-4)	10,7	428	-
PDTCH/F (MCS-1) <sup>10</sup>	10,6	212	-
PDTCH/F (MCS-2) <sup>10</sup>	13,0	260	-
PDTCH/F (MCS-3) <sup>10</sup>	16,6	332	-
PDTCH/F (MCS-4) <sup>10</sup>	19,4	388	-
PDTCH/F (MCS-5) <sup>10</sup>	24,05	481	-
PDTCH/F (MCS-6) <sup>10</sup>	31,25	625	-
PDTCH/F (MCS-7) <sup>10</sup>	47,45	949	-
PDTCH/F (MCS-8) <sup>10</sup>	57,05	1 141	-

Type of channel	net bit rate (kbit/s)	block length (bits)	block recurrence (ms)
PDTCH/F (MCS-9) <sup>10</sup>	61,85	1 237	-
PDTCH/H (MCS-1) <sup>10</sup>	5,3	212	-
PDTCH/H (MCS-2) <sup>10</sup>	6,5	260	-
PDTCH/H (MCS-3) <sup>10</sup>	8,3	332	-
PDTCH/H (MCS-4) <sup>10</sup>	9,7	388	-
PDTCH/H (MCS-5) <sup>10</sup>	12,025	481	-
PDTCH/H (MCS-6) <sup>10</sup>	15,625	625	-
PDTCH/H (MCS-7) <sup>10</sup>	23,725	949	-
PDTCH/H (MCS-8) <sup>10</sup>	28,525	1 141	-
PDTCH/H (MCS-9) <sup>10</sup>	30,925	1 237	-
full rate FACCH (FACCH/F)	9,2	184	20
half rate FACCH (FACCH/H)	4,6	184	40
enhanced circuit switched full rate FACCH (E-FACCH/F)	9,2	184	20
SDCCH	598/765 ( $\approx 0,782$ )	184	3 060/13 (235)
SACCH (with TCH) <sup>4</sup>	115/300 ( $\approx 0,383$ )	168 + 16	480
SACCH (with SDCCH) <sup>4</sup>	299/765 ( $\approx 0,391$ )	168 + 16	6 120/13 ( $\approx 471$ )
PACCH/F <sup>7</sup>		181	
PACCH/H <sup>7</sup>		181	
BCCH	598/765 ( $\approx 0,782$ )	184	3 060/13 ( $\approx 235$ )
PBCCH <sup>6</sup>	s*181/120 ( $\approx 1,508$ )	181	120
AGCH <sup>5</sup>	n*598/765 ( $\approx 0,782$ )	184	3 060/13 ( $\approx 235$ )
PAGCH <sup>7</sup>		181	
PNCH <sup>7</sup>		181	
PCH <sup>5</sup>	p*598/765 ( $\approx 0,782$ )	184	3 060/13 ( $\approx 235$ )
PPCH <sup>7</sup>		181	
RACH <sup>5</sup>	r*26/765 ( $\approx 0,034$ )	8	3 060/13 ( $\approx 235$ )
PRACH (8 bit Access Burst) <sup>7</sup>		8	
PRACH (11 bit Access Burst) <sup>7</sup>		11	
CBCH	598/765 ( $\approx 0,782$ )	184	3 060/13 ( $\approx 235$ )
NOTE 3: For data services, the net bit rate is the adaptation rate as defined in 3GPP TS 04.21.			
NOTE 4: On SACCH, 16 bits are reserved for control information on layer 1, and 168 bits are used for higher layers.			
NOTE 5: CCCH channels are common to all users of a cell; the total number of blocks (m, n, p, r) per recurrence period is adjustable on a cell by cell basis and depends upon the parameters (BS_CC_CHANs, BS_BCCH_SDCCH_COMB, BS_AG_BLKs_RES and NCP) broadcast on the BCCH and specified in 3GPP TS 05.02 and 3GPP TS 04.08.			
NOTE 6: The total number of PBCCH blocks (s) is adjustable on a cell-by-cell basis and depends upon the parameter BS_PBCCH_BLKs broadcast on the first PBCCH block and specified in 3GPP TS 05.02 and 3GPP TS 04.08.			
NOTE 7: The net bit rate for these channels in a cell can change dynamically and depends on how PDCH are configured in a cell, and upon the parameters BS_PBCCH_BLKs, BS_PAG_BLKs_RES and BS_PRACH_BLKs broadcast on the PBCCH and specified in 3GPP TS 05.02 and 3GPP TS 04.08, as well as upon how certain blocks on the PDCH are used (indicated by the message type).			
NOTE 8: For adaptive half rate speech, the blocks are divided into two classes according to the importance of the bits (the first number in the block length corresponds to the class I bits, the second number corresponds to the class II bits).			
NOTE 10: For EGPRS PDTCH, the block length in bits excludes the USF bits (downlink traffic) and all the error-check bits.			

## 5.1 Hyperframes, superframes and multiframes

A diagrammatic representation of all the time frame structures is in figure 1. The longest recurrent time period of the structure is called hyperframe and has a duration of 3 h 28 min 53 s 760 ms (or 12 533,76 s). The TDMA frames are numbered modulo this hyperframe (TDMA frame number, or FN, from 0 to 2 715 647). This long period is needed to support cryptographic mechanisms defined in 3GPP TS 03.20.

One hyperframe is subdivided in 2 048 superframes which have a duration of 6,12 seconds. The superframe is the least common multiple of the time frame structures. The superframe is itself subdivided in multiframes; four types of multiframes exist in the system:

- a 26-multiframe (51 per superframe) with a duration of 120 ms, comprising 26 TDMA frames. This multiframe is used to carry TCH (and SACCH/T) and FACCH;
- a 51-multiframe (26 per superframe) with a duration of  $\approx 235,4$  ms (3 060/13 ms), comprising 51 TDMA frames. This multiframe is used to carry BCCH, CCCH (AGCH, PCH and RACH) and SDCCH (and SACCH/C), or PBCCH and PCCCH.
- a 52-multiframe (25,5 per superframe) with a duration of 240 ms, comprising 52 TDMA frames. This multiframe is used to carry PBCCH, PCCCH (PNCH, PAGCH, PPCH and PRACH), PACCH, PDTCH, and PTCCH. The 52-multiframe is not shown in figure 1, but can be seen as two 26-multiframes, with TDMA frames numbered from 0 to 51. For Compact, this 52-multiframe (51 per superframe) is used to carry CFCCH, CSCH, CPBCCH, CPCCCH (CPNCH, CPAGCH, CPPCH, and CPRACH), PACCH, PDTCH, and PTCCH.

A TDMA frame, comprising eight time slots has a duration of  $\approx 4,62$  (60/13) ms.

## 5.2 Time slots and bursts

The time slot is a time interval of  $\approx 576,9$   $\mu$ s (15/26 ms), that is 156,25 symbol (see note) duration, and its physical content is called a burst. Four different types of bursts exist in the system. A diagram of these bursts appears in figure 1.

NOTE: One symbol is either one or three bits depending on the modulation used: GMSK or 8PSK.

- normal burst (NB): this burst is used to carry information on traffic and control channels, except for RACH, PRACH, and CPRACH. It contains 116 encrypted symbol and includes a guard time of 8,25 symbol duration ( $\approx 30,46$   $\mu$ s);
- frequency correction burst (FB): this burst is used for frequency synchronization of the mobile. It is equivalent to an unmodulated carrier, shifted in frequency, with the same guard time as the normal burst. It is broadcast together with the BCCH. The repetition of FBs is also named frequency correction channel (FCCH). For Compact, FB is broadcast together with the CPBCCH and the repetition of FBs is also named Compact frequency correction channel (CFCCH);
- synchronization burst (SB): this burst is used for time synchronization of the mobile. It contains a long training sequence and carries the information of the TDMA frame number (FN) and base station identity code (BSIC, see 3GPP TS 03.03). It is broadcast together with the frequency correction burst. The repetition of synchronization bursts is also named synchronization channel (SCH). For Compact, the repetition of synchronization bursts is also named Compact synchronization channel (CSCH);
- access burst (AB): this burst is used for random access and is characterized by a longer guard period (68,25 bit duration or 252  $\mu$ s) to cater for burst transmission from a mobile which does not know the timing advance at the first access (or after handover). This allows for a distance of 35 km. In exceptional cases of cell radii larger than 35 km, some possible measures are described in 3GPP TR 03.30. The access burst is used on the uplink of the PTCCH to allow estimation of the timing advance for MS in packet transfer mode.

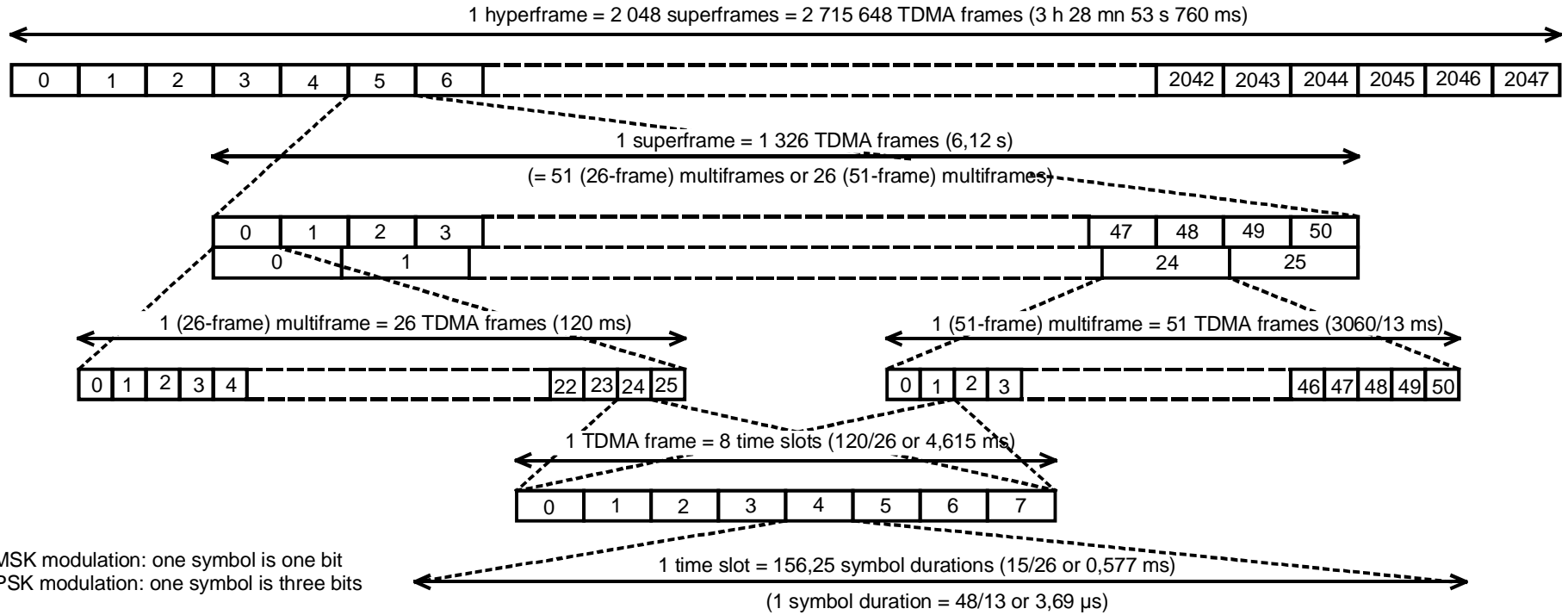

NOTE: GMSK modulation: one symbol is one bit  
 8PSK modulation: one symbol is three bits

(TB: Tail bits - GP: Guard period)

Normal burst (NB) <i>The number shown are in symbols</i>	TB 3	Encrypted bits 58	Training sequence 26	Encrypted bits 58	TB 3	GP 8,25
Frequency correction burst (FB)	TB 3	Fixed bits 142			TB 3	GP 8,25
Synchronization burst (SB)	TB 3	Encrypted bits 39	Synchronization sequence 64	Encrypted bits 39	TB 3	GP 8,25
Access burst (AB)	TB 8	Synchronization sequence 41	Encrypted bits 36	TB 3	GP 68,25	

Figure 1: Time frames time slots and bursts

### 5.3 Channel organization

The channel organization for the traffic channels (TCH), FACCHs and SACCH/T uses the 26-frame multiframe. It is organized as described in figure 2, where only one time slot per TDMA frame is considered.

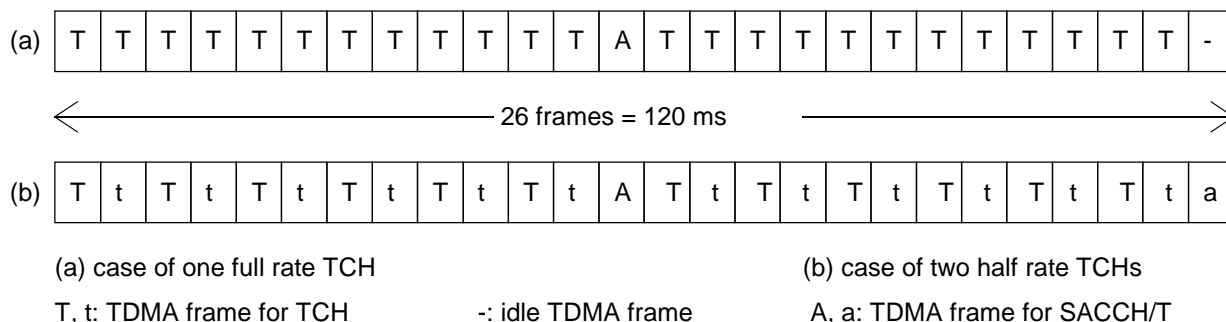

**Figure 2: Traffic channel organization**

The FACCH is transmitted by pre-empting half or all of the information bits of the bursts of the TCH to which it is associated (see 3GPP TS 05.03).

The channel organization for the control channels (except FACCHs and SACCH/T) uses the 51-frame multiframe. It is organized in the downlink and uplink as described in figure 3.

The channel organization for packet data channels uses the 52-multiframe. Full rate packet data channels are organized as described in figure 2a1. Half rate packet data channels can be organized as described in figure 2a2.

#### 52 TDMA Frames

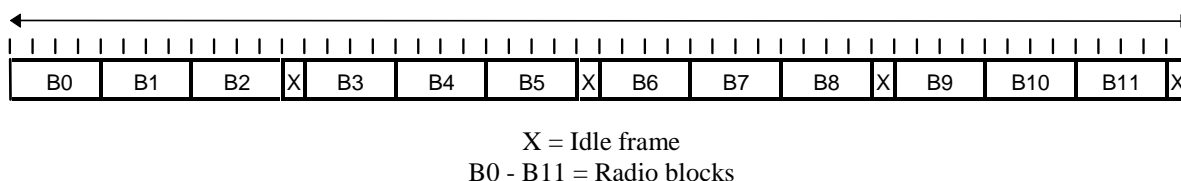

**Figure 2a1: 52-multiframe for PDCH/Fs**

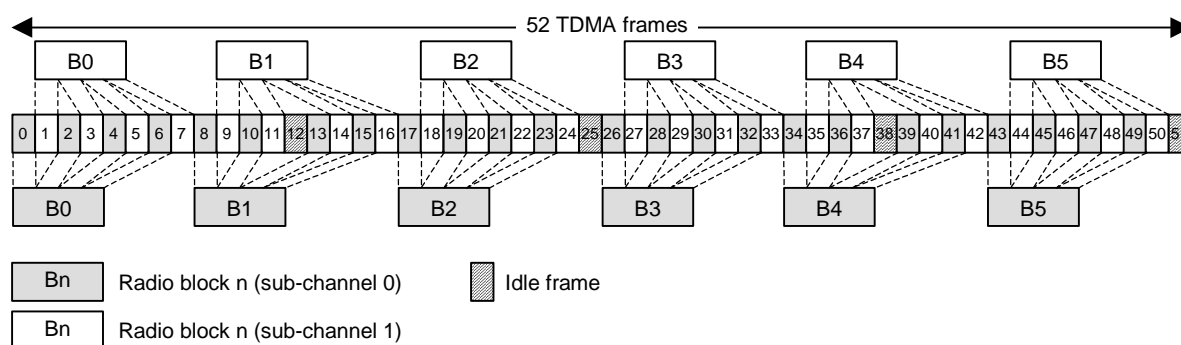

**Figure 2a2: 52-multiframe for PDCH/Hs**

---

## 6 Frequency hopping capability

The frequency hopping capability is optionally used by the network operator on all or part of its network. The main advantage of this feature is to provide diversity on one transmission link (especially to increase the efficiency of coding and interleaving for slowly moving mobile stations) and also to average the quality on all the communications through interferer's diversity. It is implemented on all mobile stations.

The principle of slow frequency hopping is that every mobile transmits its time slots according to a sequence of frequencies that it derives from an algorithm. The frequency hopping occurs between time slots and, therefore, a mobile station transmits (or receives) on a fixed frequency during one time slot ( $\approx 577 \mu\text{s}$ ) and then must hop before the time slot on the next TDMA frame. Due to the time needed for monitoring other base stations the time allowed for hopping is approximately 1 ms, according to the receiver implementation. The receive and transmit frequencies are always duplex frequencies.

The frequency hopping sequences are orthogonal inside one cell (i.e. no collisions occur between communications of the same cell), and independent from one cell to a homologue cell (i.e. using the same set of RF channels, or cell allocation). The hopping sequence is derived by the mobile from parameters broadcast at the channel assignment, namely, the mobile allocation (set of frequencies on which to hop), the hopping sequence number of the cell (which allows different sequences on homologue cells) and the index offset (to distinguish the different mobiles of the cell using the same mobile allocation). The non-hopping case is included in the algorithm as a special case. The different parameters needed and the algorithm are specified in 3GPP TS 05.02.

In case of multi band operation frequency hopping channels in different bands of operation, e.g. between channels in GSM and DCS, is not supported. Frequency hopping within each of the bands supported shall be implemented in the mobile station.

It must be noted that the basic physical channel supporting the BCCH does not hop.

For COMPACT, frequency hopping is not permitted on CPBCCH or CPCCCH for a specific amount of blocks. On other frequency hopping channels, a reduced mobile allocation is used on the corresponding blocks.



BCCH + CCCH  
(downlink)

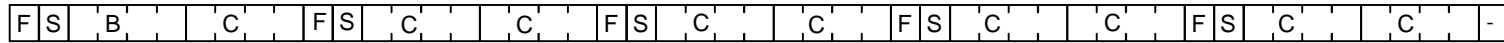

BCCH + CCCH  
(uplink)

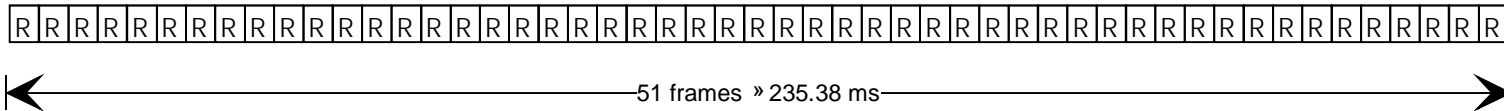

8 SDCCH/8  
(downlink)

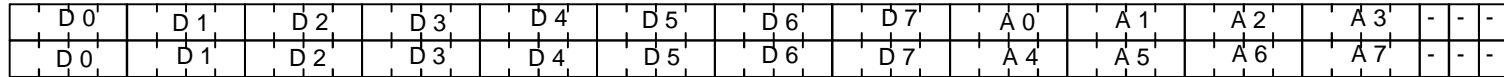

8 SDCCH/8  
(uplink)

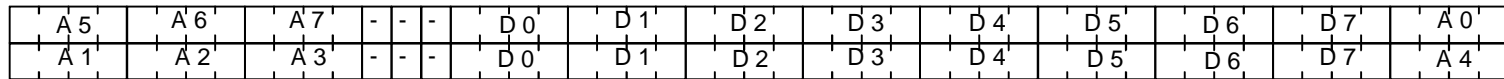

BCCH + CCCH  
4 SDCCH/4  
(downlink)

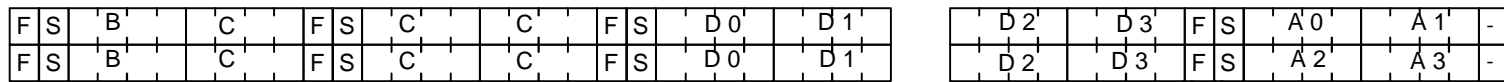

BCCH + CCCH  
4 SDCCH/4  
(uplink)



- F: TDMA frame for frequency correction burst
- B: TDMA frame for BCCH
- D: TDMA frame for SDCCH
- R: TDMA frame for RACH
- S: TDMA frame for synchronization burst
- C: TDMA frame for CCCH
- A: TDMA frame for SACCH/C

Figure 3: Channel organization in the 51-frame multiframe

## 7.1 General

A brief description of the coding schemes that are used for the logical channels mentioned in clause 2, plus the synchronization channel (SCH, see clause 5.2), is made in the following tables. For all the types of channels the following operations are made in this order:

- external coding (block coding);
- internal coding (convolutional coding);
- interleaving.

After coding the different channels (except RACH, and SCH) are constituted by blocks of coded information bits plus coded header (the purpose of the header is to distinguish between TCH and FACCH blocks). These blocks are interleaved over a number of bursts. The block size and interleaving depth are channel dependent. All these operations are specified in 3GPP TS 05.03.

Type of channel	bits/block data+parity+tail1	convolutional code rate	coded bits per block	interleaving depth
FACCH/F	184 + 40 + 4	1/2	456	8
E-FACCH/F	184 + 40 + 4	1/2	456	4
FACCH/H	184 + 40 + 4	1/2	456	6
SDCCHs SACCHs BCCH AGCH PCH				
CBCH	184 + 40 + 4	1/2	456	4
RACH	8 + 6 + 4	1/2	36	1
SCH	25 + 10 + 4	1/2	78	1

NOTE: The tail bits mentioned here are the tail bits of the convolutional code.

---

## 9 Transmission and reception

The modulated stream is then transmitted on a radio frequency carrier. The frequency bands and channel arrangements are the following:

i) GSM 450 Band;

For GSM 450, the system is required to operate in the following frequency band:

450,4 MHz to 457,6 MHz: mobile transmit, base receive;

460,4 MHz to 467,6 MHz: base transmit, mobile receive.

ii) GSM 480 Band;

For GSM 480, the system is required to operate in the following frequency band:

478,8 MHz to 486 MHz: mobile transmit, base receive;

488,8 MHz to 496 MHz: base transmit, mobile receive.

iii) GSM 850 Band;

For 850, the system is required to operate in the following band:

824 MHz to 849 MHz: mobile transmit, base receive;

869 MHz to 894 MHz: base transmit, mobile receive.

iv) Standard or primary GSM 900 Band, P-GSM;

For Standard GSM 900 Band, the system is required to operate in the following frequency band:

890 MHz to 915 MHz: mobile transmit, base receive;

935 MHz to 960 MHz: base transmit, mobile receive.

v) Extended GSM 900 Band, E-GSM (includes Standard GSM 900 band);

For Extended GSM 900 Band, the system is required to operate in the following frequency band:

880 MHz to 915 MHz: mobile transmit, base receive;

925 MHz to 960 MHz: base transmit, mobile receive.

vi) Railways GSM 900 Band, R-GSM (includes Standard and Extended GSM 900 Band);

For Railways GSM 900 Band, the system is required to operate in the following frequency band:

876 MHz to 915 MHz: mobile transmit, base receive;

921 MHz to 960 MHz: base transmit, mobile receive.

vii) DCS 1800 Band;

For DCS 1800, the system is required to operate in the following frequency band:

1 710 MHz to 1 785 MHz: mobile transmit, base receive;

1 805 MHz to 1 880 MHz: base transmit, mobile receive.

viii) PCS 1900 Band;

For PCS 1900, the system is required to operate in the following frequency band;

1 850 MHz to 1 910 MHz: mobile transmit, base receive;

1 930 MHz to 1 990 MHz: base transmit, mobile receive.

ix) TETRA 380 Band:

- for TETRA 380, the system is required to operate in the following band:

- 380 MHz to 390 MHz: mobile transmit, base receive;

- 390 MHz to 400 MHz base transmit, mobile receive.

x) TETRA 410 Band:

- for TETRA 410, the system is required to operate in the following band:

- 410 MHz to 420 MHz: mobile transmit, base receive;

- 420 MHz to 430 MHz base transmit, mobile receive.

x) TETRA 450 Band:

- for TETRA 450, the system is required to operate in the following band:

- 450 MHz to 460 MHz: mobile transmit, base receive;

- 460 MHz to 470 MHz base transmit, mobile receive.

xi) TETRA 870 Band:

- for TETRA 870, the system is required to operate in the following band:

- 870 MHz to 876 MHz: mobile transmit, base receive;

- 915 MHz to 921 MHz base transmit, mobile receive.

NOTE 1: The term GSM 400 is used for any GSM or TETRA system, which operates in any 400 MHz band or the TETRA 380 band.

NOTE 2: The term GSM 850 is used for any GSM system which operates in the GSM 850 MHz.

NOTE 3: The term GSM 900 is used for any GSM system, which operates in any 900 MHz or TETRA 870 bands.

NOTE 4: The BTS may cover a complete band, or the BTS capabilities may be restricted to a subset only, depending on the operator needs.

Operators may implement networks on a combination of the frequency bands above to support multi band mobile stations, which are defined in 3GPP TS 02.06.

The RF channel spacing is 200 kHz, allowing for 35 (GSM 450), 48 (TETRA 380), 48 (TETRA 410), 48 (TETRA 450), 35 (GSM 480), 124 (GSM 850), 28 (TETRA 870), 194 (GSM 900), 374 (DCS 1800) and 299 (PCS 1900) radio frequency channels, thus leaving a guard band of 200 kHz at each end of the sub-bands.

The carrier frequency is designated by the absolute radio frequency channel number (ARFCN). If  $F_l(n)$  is the frequency value of the carrier ARFCN  $n$  in the lower band, and  $F_u(n)$  the corresponding frequency value in the upper band, the numbers are:

P-GSM 900	$F_l(n) = 890 + 0,2*n$	$1 \leq n \leq 124$	$F_u(n) = F_l(n) + 45$
E-GSM 900	$F_l(n) = 890 + 0,2*n$ $F_l(n) = 890 + 0,2*(n-1024)$	$0 \leq n \leq 124$ $975 \leq n \leq 1\ 023$	$F_u(n) = F_l(n) + 45$
R-GSM 900	$F_l(n) = 890 + 0,2*n$ $F_l(n) = 890 + 0,2*(n-1024)$	$0 \leq n \leq 124$ $955 \leq n \leq 1\ 023$	$F_u(n) = F_l(n) + 45$
DCS 1800	$F_l(n) = 1\ 710,2 + 0,2*(n-512)$	$512 \leq n \leq 885$	$F_u(n) = F_l(n) + 95$
PCS 1900	$F_l(n) = 1\ 850,2 + 0,2*(n-512)$	$512 \leq n \leq 810$	$F_u(n) = F_l(n) + 80$
GSM 450	$F_l(n) = 450,6 + 0,2*(n-259)$	$259 \leq n \leq 293$	$F_u(n) = F_l(n) + 10$
GSM 480	$F_l(n) = 479 + 0,2*(n-306)$	$306 \leq n \leq 340$	$F_u(n) = F_l(n) + 10$
GSM 850	$F_l(n) = 824,2 + 0,2*(n-128)$	$128 \leq n \leq 251$	$F_u(n) = F_l(n) + 45$
TETRA 380	$F_l(n) = 380,2 + 0,2*(n-356)$	$356 \leq n \leq 404$	$F_u(n) = F_l(n) + 10$
TETRA 410	$F_l(n) = 410,2 + 0,2*(n-406)$	$406 \leq n \leq 464$	$F_u(n) = F_l(n) + 10$
TETRA 450	$F_l(n) = 450,6 + 0,2*(n-259)$	$257 \leq n \leq 305$	$F_u(n) = F_l(n) + 10$
TETRA 870	$F_l(n) = 890 + 0,2*(n-1\ 024)$	$925 \leq n \leq 954$	$F_u(n) = F_l(n) + 45$

Frequencies are in MHz.

The specific RF channels, together with the requirements on the transmitter and the receiver will be found in 3GPP TS 05.05 (Transmission and reception).

In order to allow for low power consumption for different categories of mobiles (e.g. vehicle mounted, hand-held, ...), different power classes have been defined. For GSM 400, GSM 850 (MXM 850 MS as defined in 3GPP TS 05.05) and GSM 900 there are four power classes with the maximum power class having 8 W peak output power (ca 1 W mean output power) and the minimum having 0,8 W peak output power. For DCS 1800 there are three power classes of 4 W peak output power, 1 W peak output power (ca 0,125 W mean) and 0,25 W peak output power. For PCS 1900 there are three power classes of 2 watts, 1 watt and 0,25 watt peak output power.

Multi band mobile stations may have any combinations of the allowed power classes for each of the bands supported.

The power classes are specified in 3GPP TS 05.05.

The requirements on the overall transmission quality together with the measurement conditions are also in 3GPP TS 05.05.

---

## 10 Other layer 1 functions

The transmission involves other functions. These functions may necessitate the handling of specific protocols between BS and MS. Relevant topics for these cases are:

- 1) The power control mechanisms which adjust the output level of the mobile station (and optionally of the base station) in order to ensure that the required quality is achieved with the less possible radiated power. Power levels with 2 dB steps have been defined for that purpose. This is described in 3GPP TS 05.08 (radio subsystem link control) and 3GPP TS 05.05.
- 2) The synchronization of the receiver with regard to frequency and time (time acquisition and time frame alignment). The synchronization problems are described in TS 100 912 (synchronization aspects).
- 3) The hand-over and quality monitoring which are necessary to allow a mobile to continue a call during a change of physical channel. This can occur either because of degradation of the quality of the current serving channel, or because of the availability of another channel which can allow communication at a lower Tx power level, or to prevent a MS from grossly exceeding the planned cell boundaries. In the case of duplex point-to-point connections, the choice of the new channel is done by the network (base station control and MSC) based on measurements (on its own and on adjacent base stations) that are sent on a continuous basis by the mobile station via the SACCHs. The requirements are specified in 3GPP TS 05.08 (radio subsystem link control).
- 4) The measurements and sub-procedures used in the first selection or reselection of a base station by a mobile are specified in 3GPP TS 05.08 (radio subsystem link control). The overall selection and reselection procedures, together with the idle mode activities of a mobile are defined in 3GPP TS 03.22 (functions related to MS in idle mode and group receive mode and GPRS mode).

---

## 11 Performance

Under typical urban fading conditions (i.e. multipath delays no greater than 5  $\mu$ s), the quality threshold for PDTCH/CS1 is reached at a C/I value of approximately 9 dB. The maximum sensitivity is approximately -104 dBm for base stations and GSM mobiles and -102 dBm for GSM small MSs and PCS 1900 MSs and -100 dBm for DCS 1800 hand-helds (see 3GPP TS 05.05).

Multi band MSs shall meet the requirements on each band of operation respectively.

---

## Annex D (normative): Modifications to GSM 05.02

This annex details the modified clauses of GSM 05.02 which are applicable to TAPS.

All references to other GSM standards and specifications are to the standards as modified by the present document.

Where the following channel names appear in diagrams, they should be treated as if they had been deleted.

- CTSARCH
- CTSAGCH
- CTSBCH
- CTSPCH
- TCH/EF
- TCH/AFS
- TCH/AHS
- TCH/HS
- TCH/EFS
- TCH/AF
- TCH/AH
- TCH/FS
- E-TCH/F followed by a data rate
- TCH/F followed by a data rate
- TCH/H followed by a data rate
- HSCSD
- ECSD
- NCH

The following clauses have the same numbering as in GSM 05.02.

### 3.2.1 General

Packet data traffic channels (PDTCHs) are intended to carry user data in packet switched mode. For the purpose of this EN, any reference to traffic channel does not apply to PDTCH unless explicitly stated.

All traffic channels are bi-directional unless otherwise stated.

Multiple packet data traffic channels can be allocated to the same MS. This is referred to as multislot packet configurations, as defined in clause 6.4.2.2.

A combination of a half rate traffic channel and a half rate packet data traffic channel on the same basic physical channel can be allocated to the same MS as defined in clause 6.4.2.3.

A combination of a traffic channel and one or more full rate packet data traffic channels can be allocated to the same MS.

### 3.3.1 General

Control channels are intended to carry signalling or synchronization data. Three categories of control channel are defined: broadcast, common, and dedicated control channels. Specific channels within these categories are defined in the following clauses.

#### 3.3.2.4.1 Packet Broadcast Control Channel (PBCCH)

The PBCCH broadcasts parameters used by the MS to access the network for packet transmission operation. In addition to those parameters the PBCCH reproduces the information transmitted on the BCCH, such that a MS in GPRS attached mode monitors the PBCCH only, if it exists. The existence of the PBCCH in the cell is indicated on the BCCH. In the absence of PBCCH, the BCCH shall be used to broadcast information for packet operation.

Of the many parameters contained in the PBCCH, the use of the following parameters, as defined in 3GPP TS 04.60 are referred to in clauses 6.5 and 6.3.2:

- a) BS\_PBCCH\_BLKs (1, ..., 4) indicates the number of blocks allocated to the PBCCH in the multiframe (see clause 6.3.2.3.3).
- b) BS\_PCC\_CHANS indicates the number of physical channels carrying PCCCHs including the physical channel carrying the PBCCH.
- c) BS\_PAG\_BLKs\_RES indicates the number of blocks on each PDCH carrying PCCCH per multiframe where neither PPCH nor PBCCH should appear (see clause 6.3.2.3.4).
- d) BS\_PRACH\_BLKs indicates the number of blocks reserved in a fixed way to the PRACH channel on any PDCH carrying PCCCH (see clause 6.3.2.2.3).

#### 3.3.3.1 Common control type channels, known when combined as a common control channel (CCCH)

- i) Paging channel (PCH): Downlink only, used to page mobiles.
- ii) Random access channel (RACH): Uplink only, used to request allocation of a SDCCH.
- iii) Access grant channel (AGCH): Downlink only, used to allocate a SDCCH or directly a TCH.

##### 3.3.3.2.1 Packet Common Control Channels (PCCCH)

- i) Packet Paging channel (PPCH): Downlink only, used to page MS.
- ii) Packet Random access channel (PRACH): Uplink only, used to request allocation of one or several PDTCHs (for uplink or downlink direction).
- iii) Packet Access grant channel (PAGCH): Downlink only, used to allocate one or several PDTCH.
- iv) Packet Notification channel (PNCH): Downlink only, used to notify MS of PTM-M call.

If a PCCCH is not allocated, the information for packet switched operation is transmitted on the CCCH.

#### 3.3.4.1 Circuit switched dedicated control channels

- i) Slow, TCH/F or E-TCH/F associated, control channel (SACCH/TF).
- ii) Fast, TCH/F associated, control channel (FACCH/F).
- iii) Slow, TCH/H associated, control channel (SACCH/TH).
- iv) Fast, TCH/H associated, control channel (FACCH/H).
- v) Stand alone dedicated control channel (SDCCH/8).
- vi) Slow, SDCCH/8 associated, control channel (SACCH/C8).

vii) Stand alone dedicated control channel, combined with CCCH (SDCCH/4).

viii) Slow, SDCCH/4 associated, control channel (SACCH/C4).

All associated control channels have the same direction (bi-directional or unidirectional) as the channels they are associated to. The unidirectional SACCH/MD is defined as the downlink part of SACCH/M.

### 5.2.3 Normal burst (NB)

Normal burst for GMSK

Bit Number (BN)	Length of field	Contents of field	Definition
0 - 2	3	tail bits	(below)
3 - 60	58	encrypted bits (e0 . e57)	05.03
61 - 86	26	training sequence bits	(below)
87 - 144	58	encrypted bits (e58 . e115)	05.03
145 - 147	3	tail bits	(below)
(148 - 156)	8,25	guard period (bits)	(clause 5.2.8)

- where the "tail bits" are defined as modulating bits with states as follows:

(BN0, BN1, BN2) = (0, 0, 0) and

(BN145, BN146, BN147) = (0, 0, 0)

- where the "training sequence bits" are defined as modulating bits with states as given in the following table according to the training sequence code, TSC. For broadcast and common control channels, the TSC must be equal to the BCC, as defined in 3GPP TS 03.03 and as described in the present document in clause 3.3.2. In networks supporting E-OTD Location services (see GSM 03.71 annex C), the TSC shall be equal to the BCC for all normal bursts on BCCH frequencies.

NOTE: For COMPACT, for PDTCH/PACCH on primary and secondary carriers that are indicated in EXT\_FREQUENCY\_LIST by parameter INT\_FREQUENCY and in INT\_MEAS\_CHAN\_LIST (see clauses 10.1.5 and 10.2.3.2.2 of 3GPP TS 05.08), the TSCs should be equal to the BCC, as defined in 3GPP TS 03.03 and as described in the present document in clause 3.3.2, otherwise the accuracy of interference measurement reporting may be compromised.

Training Sequence Code (TSC)	Training sequence bits (BN61, BN62 .. BN86)
0	(0,0,1,0,0,1,0,1,1,1,0,0,0,0,1,0,0,0,1,0,0,1,0,1,1,1)
1	(0,0,1,0,1,1,0,1,1,1,0,1,1,1,1,0,0,0,1,0,1,1,0,1,1,1)
2	(0,1,0,0,0,0,1,1,1,0,1,1,0,1,1,0,1,0,0,1,0,0,0,0,1,1,1,0)
3	(0,1,0,0,0,1,1,1,1,0,1,1,0,1,0,0,0,1,0,0,0,1,1,1,1,0)
4	(0,0,0,1,1,0,1,0,1,1,1,0,0,1,0,0,0,0,0,1,1,0,1,0,1,1)
5	(0,1,0,0,1,1,1,0,1,0,1,1,0,0,0,0,0,1,0,0,1,1,1,0,1,0)
6	(1,0,1,0,0,1,1,1,1,0,1,1,0,0,0,1,0,1,0,0,1,1,1,1,1)
7	(1,1,1,0,1,1,1,1,0,0,0,1,0,0,1,0,1,1,1,0,1,1,1,1,0,0)

Under certain circumstances only half the encrypted bits present in a normal burst will contain complete information. The binary state of the remaining bits is not specified.



## Normal burst for 8PSK

Bit Number (BN)	Length of field (bits)	Contents of field	Definition
0 to 8	9	tail bits	(below)
9 to 182	174	encrypted bits (e0 . e173)	05.03
183 to 260	78	training sequence bits	(below)
261 to 434	174	encrypted bits (e174 . e347)	05.03
435 to 443	9	tail bits	(below)
444 to 468	24.75	guard period	clause 5.2.8

- where the "tail bits" are defined as modulating bits with states as follows (bits are grouped in symbols separated by ";"):

(BN0, BN1 .. BN8) = (1,1,1;1,1,1;1,1,1) and

(BN435, BN436 .. BN443) = (1,1,1;1,1,1;1,1,1)

- where the "training sequence bits" are defined as modulating bits with states as given in the following table according to the training sequence code, TSC. For broadcast and common control channels, the TSC must be equal to the BCC, as defined in 3GPP TS 03.03 and as described in the present document in clause 3.3.2. In networks supporting E-OTD Location services (see GSM 03.71 annex C), the TSC shall be equal to the BCC for all normal bursts on BCCH frequencies.

Training Sequence Code (TSC)	Training sequence symbols (BN183, BN184 .. BN260)
0	(1,1,1;1,1,1;0,0,1;1,1,1;1,1,1;0,0,1;1,1,1;0,0,1;0,0,1;0,0,1;1,1,1;1,1,1;1,1,1;1,1,1;0,0,1;1,1,1;1,1,1;0,0,1;1,1,1;0,0,1;0,0,1;0,0,1;0,0,1)
1	(1,1,1;1,1,1;0,0,1;1,1,1;0,0,1;0,0,1;1,1,1;0,0,1;0,0,1;0,0,1;1,1,1;0,0,1;0,0,1;0,0,1;0,0,1;1,1,1;1,1,1;1,1,1;0,0,1;1,1,1;0,0,1;0,0,1;0,0,1;0,0,1)
2	(1,1,1;0,0,1;1,1,1;1,1,1;1,1,1;1,1,1;0,0,1;1,1,1;0,0,1;0,0,1;1,1,1;0,0,1;0,0,1;0,0,1;1,1,1;0,0,1;1,1,1;1,1,1;0,0,1;1,1,1;0,0,1;0,0,1;0,0,1;1,1,1)
3	(1,1,1;0,0,1;1,1,1;1,1,1;1,1,1;0,0,1;0,0,1;0,0,1;0,0,1;1,1,1;1,1,1;0,0,1;0,0,1;1,1,1;0,0,1;1,1,1;0,0,1;1,1,1;1,1,1;0,0,1;0,0,1;0,0,1;0,0,1;1,1,1)
4	(1,1,1;1,1,1;1,1,1;0,0,1;0,0,1;1,1,1;0,0,1;1,1,1;0,0,1;0,0,1;0,0,1;1,1,1;1,1,1;0,0,1;0,0,1;1,1,1;1,1,1;1,1,1;0,0,1;0,0,1;1,1,1;0,0,1;0,0,1;0,0,1)
5	(1,1,1;0,0,1;1,1,1;1,1,1;0,0,1;0,0,1;0,0,1;1,1,1;0,0,1;1,1,1;0,0,1;0,0,1;1,1,1;0,0,1;1,1,1;1,1,1;1,1,1;0,0,1;1,1,1;0,0,1;0,0,1;1,1,1;0,0,1;1,1,1)
6	(0,0,1;1,1,1;0,0,1;1,1,1;1,1,1;0,0,1;0,0,1;0,0,1;0,0,1;0,0,1;1,1,1;0,0,1;0,0,1;1,1,1;0,0,1;0,0,1;1,1,1;0,0,1;0,0,1;0,0,1;0,0,1;0,0,1;0,0,1)
7	(0,0,1;0,0,1;0,0,1;1,1,1;0,0,1;0,0,1;0,0,1;0,0,1;0,0,1;1,1,1;1,1,1;1,1,1;1,1,1;0,0,1;0,0,1;1,1,1;1,1,1;0,0,1;0,0,1;0,0,1;0,0,1;0,0,1;1,1,1)

## 5.2.5 Synchronization Burst (SB)

Bit Number (BN)	Length of field	Contents of field	Definition
0 - 2	3	tail bits	(below)
3 - 41	39	encrypted bits (e0 . e38)	05.03
42 - 105	64	extended training sequence bits	(below)
106 - 144	39	encrypted bits (e39 .. e77)	05.03
145 - 147	3	tail bits	(below)
(148 - 156)	8,25	guard period (bits)	clause 5.2.8)

- where the "tail bits" are defined as modulating bits with states as follows:

(BN0, BN1, BN2) = (0, 0, 0) and

(BN145, BN146, BN147) = (0, 0, 0)

- where the "extended training sequence bits" are defined as modulating bits with states as follows:

$$\begin{aligned} (\text{BN42, BN43 .. BN105}) &= (1, 0, 1, 1, 1, 0, 0, 1, 0, 1, 1, 0, 0, 0, 1, 0, 0, 0, 0, 0, 0, 1, 0, \\ &0, 0, 0, 0, 0, 1, 1, 1, 1, 0, 0, 1, 0, 1, 1, 0, 1, 0, 1, 0, 0, 0, \\ &1, 0, 1, 0, 1, 1, 1, 0, 1, 1, 0, 0, 0, 0, 1, 1, 0, 1, 1) \end{aligned}$$

except for COMPACT synchronization bursts furthermore, where states are as follows:

$$\begin{aligned} (\text{BN42, BN43 .. BN105}) &= (1, 1, 1, 0, 1, 1, 0, 0, 0, 0, 1, 1, 0, 1, 1, 1, 0, 1, 0, 1, 0, 0, 0, 1, 0, 1, \\ &0, 1, 1, 0, 1, 0, 0, 1, 1, 1, 1, 0, 0, 0, 0, 0, 0, 0, 0, 1, 0, 0, 0, 1, 1, 0, 1, 0, 0, 1, 1, 1, 0) \end{aligned}$$

## 6.2.1 General

The parameters used in the function which maps TDMA frame number onto radio frequency channel are defined in clause 6.2.2. The definition of the actual mapping function, or as it is termed, hopping sequence generation is given in clause 6.2.3.

## 6.2.2 Parameters

The following parameters are required in the mapping from TDMA frame number to radio frequency channel for a given assigned channel.

General parameters of the BTS, specific to one BTS, and broadcast in the BCCH and SCH:

- i) CA: Cell allocation of radio frequency channels.
- ii) FN: TDMA frame number, broadcast in the SCH, in form T1, T2, T3' (see clause 3.3.2). For COMPACT, FN is broadcast in the CSCH, in form R1, R2 (see clause 3.2.2).

Specific parameters of the channel, defined in the channel assignment message:

- i) MA: Mobile allocation of radio frequency channels, defines the set of radio frequency channels to be used in the mobiles hopping sequence. The MA contains N radio frequency channels, where  $1 \leq N \leq 64$ .

For COMPACT, the reduced MA (see 3GPP TS 04.60) shall be used for a fixed amount of data blocks, see clause 6.2.4.

- ii) MAIO: Mobile allocation index offset (0 to N-1, 6 bits).

For COMPACT, MAIO\_2 shall be used for the data blocks using the reduced MA.

- iii) HSN: Hopping sequence (generator) number (0 to 63, 6 bits).

## 6.2.3 Hopping sequence generation

For a given set of parameters, the index to an absolute radio frequency channel number (ARFCN) within the mobile allocation (MAI from 0 to N-1, where MAI=0 represents the lowest absolute radio frequency channel number (ARFCN) in the mobile allocation, ARFCN is in the range 0 to 7023 and the frequency value can be determined according to 3GPP TS 05.05 sec 2 with  $n = \text{ARFCN}$ ), is obtained with the following algorithm:

**if** HSN = 0 (cyclic hopping) **then:**

$$\text{MAI, integer (0 .. N-1)} : \text{MAI} = (\text{FN} + \text{MAIO}) \text{ modulo } N$$

**else:**

$$\text{M, integer (0 .. 152)} : \text{M} = \text{T2} + \text{RNTABLE}((\text{HSN} \text{ xor } \text{T1R}) + \text{T3})$$

$$\text{S, integer (0 .. N-1)} : \text{M}' = \text{M} \text{ modulo } (2 \wedge \text{NBIN})$$

$$\text{T}' = \text{T3} \text{ modulo } (2 \wedge \text{NBIN})$$

**if** M' < N **then:**

$$\text{S} = \text{M}'$$

else:

$$S = (M'+T') \text{ modulo } N$$

$$\text{MAI, integer } (0 \dots N-1) : \text{MAI} = (S + \text{MAIO}) \text{ modulo } N$$

NOTE: The use of cyclic hopping where  $(N) \bmod 13 = 0$  should be avoided.

where:

T1R: time parameter T1, reduced modulo 64 (6 bits)

T3: time parameter, from 0 to 50 (6 bits)

T2: time parameter, from 0 to 25 (5 bits)

NBIN: number of bits required to represent  $N = \text{INTEGER}(\log_2(N)+1)$

^: raised to the power of

xor: bit-wise exclusive or of 8 bit binary operands

RNTABLE: table of 114 integer numbers, defined below:

Address	Contents									
000...009:	48,	98,	63,	1,	36,	95,	78,	102,	94,	73,
010...019:	0,	64,	25,	81,	76,	59,	124,	23,	104,	100,
020...029:	101,	47,	118,	85,	18,	56,	96,	86,	54,	2,
030...039:	80,	34,	127,	13,	6,	89,	57,	103,	12,	74,
040...049:	55,	111,	75,	38,	109,	71,	112,	29,	11,	88,
050...059:	87,	19,	3,	68,	110,	26,	33,	31,	8,	45,
060...069:	82,	58,	40,	107,	32,	5,	106,	92,	62,	67,
070...079:	77,	108,	122,	37,	60,	66,	121,	42,	51,	126,
080...089:	117,	114,	4,	90,	43,	52,	53,	113,	120,	72,
090...099:	16,	49,	7,	79,	119,	61,	22,	84,	9,	97,
100...109:	91,	15,	21,	24,	46,	39,	93,	105,	65,	70,
110...113:	125,	99,	17,	123,						

The hopping sequence generation algorithm is represented diagrammatically in figure 6.

This algorithm applies also to COMPACT, whereby the parameters T1, T2 and T3 shall be calculated from FN.

### 6.3.1.2 Key to the mapping table of clause 7

The following relates to the tables of clause 7. The columns headed:

- i) "Channel designation" gives the precise acronym for the channel to which the mapping applies.
- ii) "Sub-channel number" identifies the particular sub-channel being defined where a basic physical channel supports more than one channel of this type.
- iii) "Direction" defines whether the mapping given applies identically to downlink and uplink (D&U), or to downlink (D) or uplink (U) only.
- iv) "Allowable timeslots assignments" defines whether the channel can be supported on, or assigned to, any of the timeslots, or only on specific timeslots.
- v) "Allowable RF channel assignments" defines whether the channel can use any or all of the radio frequency channels in the cell allocation (CA), or only the BCCH carrier (C0). It should be noted that any allocated channel Cx within CA could be any radio frequency channel, and that no ordering of radio frequency channel number is implied. For example, allocated channel C0 need not have the lowest radio frequency channel number of the allocation.
- vi) "Burst type" defines which type of burst as defined in clause 5.2 is to be used for the physical channel.

vii) "Repeat length in TDMA frames" defines how many TDMA frames occur before the mapping for the interleaved blocks repeats itself, e.g. 51.

viii) "Interleaved block TDMA frame mapping" defines, within the parentheses, the TDMA frames used by each interleaved block (e.g. 0..3). The numbers given equate to the TDMA frame number (FN) modulo the number of TDMA frames per repeat length; Therefore, the frame is utilized when:

TDMA frame mapping number = (FN)mod repeat length given.

Where there is more than one block shown, each block is given a separate designation, e.g. B0, B1. Where diagonal interleaving is employed then all of the TDMA frames included in the block are given, and hence the same TDMA frame number can appear more than once (see 3GPP TS 05.03). It should be noted that the frame mapping for the SACCH/T channel differs according to the timeslot allocated in order to lower the peak processing requirements of the BSS.

### 6.3.1.3 Mapping of BCCH data

In order to facilitate the MS operation, it is necessary to transmit some System Information messages in defined multiframe and defined blocks within one multiframe, as follows (where  $TC = (FN \text{ DIV } 51) \text{ mod } (8)$ ). Also for some System Information messages, the position where they are transmitted is contained in other System Information messages:

System Information Message	Sent when TC =	Allocation
Type 1	0	BCCH Norm
Type 2	1	BCCH Norm
Type 2 bis	5	BCCH Norm
Type 2 ter	5 or 4	BCCH Norm
Type 2 quater	5 or 4	BCCH Norm
	or	
	5	BCCH Ext
Type 3	2 and 6	BCCH Norm
Type 4	3 and 7	BCCH Norm
Type 7	7	BCCH Ext
Type 8	3	BCCH Ext
Type 9	4	BCCH Norm
Type 13	4	BCCH norm
	or	
	0	BCCH Ext
Type 16	6	BCCH Ext
Type 17	2	BCCH Ext
Type 18	Not fixed	Not fixed
Type 19	Not Fixed	Not Fixed
Type 20	Not fixed	Not fixed

This clause defines requirements on minimum scheduling: the network may send any System Information message when sending of a specific System Information message is not required. The following rules apply:

- i) BCCH Ext may share the resource with PCH and AGCH (see clause 6.5.1).
- iii) System information type 2 bis or 2 ter messages are sent if needed, as determined by the system operator. If only one of them is needed, it is sent when  $TC = 5$ . If both are needed, 2bis is sent when  $TC = 5$  and 2ter is sent at least once within any of 4 consecutive occurrences of  $TC = 4$ . A SI 2 message will be sent at least every time  $TC = 1$ . System information type 2 quater is sent if needed, as determined by the system operator. If sent on BCCH Norm, it shall follow the same rules as System information type 2 ter. If sent on BCCH Ext, it is sent at each occurrence of  $TC = 5$ .
- iv) The definitions of BCCH Norm and BCCH Ext are given in clause 7 table 3 of 5.
- v) Use of System Information type 7 and 8 is not always necessary. It is necessary if System Information type 4 does not contain all information needed for cell selection and reselection.
- vi) System Information type 9 is sent in those blocks with  $TC = 4$  which are specified in system information type 3 as defined in 3GPP TS 04.08.

- vii) System Information type 13 is only related to the GPRS service. System Information Type 13 need only be sent if GPRS support is indicated in one or more of System Information Type 3 or 4 or 7 or 8 messages. These messages also indicate if the message is sent on the BCCH Norm or if the message is transmitted on the BCCH Ext. In the case that the message is sent on the BCCH Norm, it is sent at least once within any of 4 consecutive occurrences of TC=4.
- viii) System Information type 16 and 17 are only related to the SoLSA service.
- ix) System Information type 18 and 20 are sent in order to transmit non-GSM broadcast information. The frequency with which they are sent is determined by the system operator. System Information type 9 identifies the scheduling of System Information type 18 and 20 messages.
- x) System Information Type 19 is sent if COMPACT neighbours exist. If System Information Type 19 is present, then its scheduling shall be indicated in System Information Type 9.

All the allowable timeslot assignments in a frame (see table 3 of 7 in clause 7) shall contain the same information.

#### 6.3.2.2.1 Mapping of uplink packet traffic channel (PDTCH/U) and PACCH/U

The PDCHs where the MS may expect occurrence of its PDTCH/U(s) or PACCH/U for a mobile originated transfer is indicated in resource allocation messages (see 3GPP TS 04.60). PACCH/U shall be allocated respecting the resources allocated to the MS class. For each PDCH allocated to the MS, an Uplink State Flag (R0... R7) is given to the MS.

The occurrence of the PDTCH/U and/or the PACCH/U at given block(s)  $B_x$  (where  $B_x = B_0...B_n$ ;  $n=5$  for the PDTCH/HU and  $n=11$  for the PDTCH/FU) in the 52-multiframe structure for a given MS on a given PDCH shall be indicated by the value of the Uplink State Flag (USF) contained in the header of the preceding block transmitted in the downlink of the same PDCH, that is to say  $B_{(x-1)}$  in the same multiframe if  $x \geq 1$  or  $B_{(n)}$  in the previous multiframe if  $x=0$ . If the USF in block  $B_{(x-1)}$  indicates that block  $B_{(x)}$  shall be used by an MS for which the USF\_GRANULARITY is set to 1 (corresponding to 4 blocks) in the last assignment message, that MS shall also use the three following blocks. The USF corresponding to the last three blocks shall be set to an unused value. The MS may transmit a PDTCH block or a PACCH block on any of the uplink blocks used by the MS. The occurrence of the PACCH/U associated to a PDTCH/D shall be indicated by the network by polling the MS (see 3GPP TS 04.60).

NOTE 1: This clause specifies how the network shall signal that the MS is allowed to use the uplink. The operation of the MS is specified in 3GPP TS 04.60. In particular cases of fixed allocation, extended dynamic allocation or exclusive allocation, the MS may not need to monitor the USF on all allocated PDCHs.

NOTE 2: The PDCH/HU is only assigned in exclusive allocation (see 3GPP TS 04.60).

For COMPACT, USF\_GRANULARITY should be set to 0 (corresponding to 1 block) for dynamic allocation for the following cases:

- i) for odd timeslot numbers (TN) 1, 3, 5, and 7 in nominal and large cells;
- ii) for even timeslot numbers (TN) 0, 2, 4, and 6 in large cells.

#### 6.3.2.2.2 Mapping of the Packet Timing Advance Control Channel (PTCCH/U)

The PDCH carrying the PTCCH/U of one MS is defined in the resource allocation message (see 3GPP TS 04.60). PTCCH/U shall be mapped to one of the time slots where PDTCH(s) are allocated to the MS. PTCCH/U shall be allocated respecting the resources allocated to the MS class. An MS shall be allocated a sub-channel of the PTCCH/U (0...15) as defined in clause 7 table 6, where the sub-channel number is equal to the Timing Advance Index (TAI) indicated in the resource allocation message (see 3GPP TS 04.60).

### 6.4.1 Permitted channel combinations onto a basic physical channel

The following are the permitted ways, as defined by GSM 04.03, in which channels can be combined onto basic physical channels (numbers appearing in parenthesis after channel designations indicate sub-channel numbers; channels and sub-channels need not necessarily be assigned):

- i) TCH/F + FACCH/F + SACCH/TF
- ii) TCH/H(0,1) + FACCH/H(0,1) + SACCH/TH(0,1)

- iii) TCH/H(0,0) + FACCH/H(0,1) + SACCH/TH(0,1) + TCH/H(1,1)
- iv) FCCH + SCH + BCCH + CCCH
- v) FCCH + SCH + BCCH + CCCH + SDCCH/4(0..3) + SACCH/C4(0..3)
- vi) BCCH + CCCH
- vii) SDCCH/8(0..7) + SACCH/C8(0..7)
- xi) PBCCH+PCCCH+PDTCH/F+PACCH/F+PTCCH/F
- xii) PCCCH+PDTCH/F+PACCH/F+PTCCH/F
- xiii) PDTCH/F+PACCH/F+PTCCH/F

where CCCH = PCH + RACH + AGCH

and PCCCH=PPCH+PRACH+PAGCH+PNCH

- xxii) CFCCH + CSCH + CPBCCH + CPCCCH + PDTCH/F + PACCH/F + PTCCH/F
- xxiii) CPCCCH+PDTCH/F+PACCH/F+PTCCH/F
- xxiv) TCH/H(0,1) + FACCH/H(0,1) + SACCH/TH(0,1) + PDTCH/H(1,0) + PACCH/H(1,0)

NOTE 1: Where the SMSCB is supported, the CBCH replaces SDCCH number 2 in cases v) and vii) above.

NOTE 2: A combined CCCH/SDCCH allocation (case v) above) may only be used when no other CCCH channel is allocated.

NOTE 5: Combinations xxii) and xxiii) shall be used for COMPACT on serving time groups.

## 6.4.2 Multislot configurations

A multislot configuration consists of multiple packet switched traffic channels together with associated control channels, allocated to the same MS. The multislot configuration occupies up to 8 basic physical channels, with different timeslot numbers (TN) but with the same frequency parameters (ARFCN or MA, MAIO and HSN) and the same training sequence (TSC).

### 6.5.1 General

- i) A base transceiver station must transmit a burst in every timeslot of every TDMA frame in the downlink of radio frequency channel C0 of the cell allocation (to allow mobiles to make power measurements of the radio frequency channels supporting the BCCH, see 3GPP TS 05.08). In order to achieve this requirement a dummy burst is defined in clause 5.2.6 which shall be transmitted by the base transceiver station on all timeslots of all TDMA frames of radio frequency channel C0 for which no other channel requires a burst to be transmitted.
- ii) Timeslot number 0 of radio frequency channel C0 of the cell allocation must support either channel combinations iv) or v) in clause 6.4.1. No other timeslot or allocated channel from the cell allocation is allowed to support channel combinations iv) or v) in clause 6.4.1.
- iii) The parameter BS\_CC\_CHANS in the BCCH defines the number of basic physical channels supporting common control channels (CCCHs). All shall use timeslots on radio frequency channel C0 of the cell allocation. The first CCCH shall use timeslot number 0, the second timeslot number 2, the third timeslot number 4 and the fourth timeslot number 6. Each CCCH carries its own CCCH\_GROUP of mobiles in idle mode. Mobiles in a specific CCCH\_GROUP will listen for paging messages and make random accesses only on the specific CCCH to which the CCCH\_GROUP belongs. The method by which a mobile determines the CCCH\_GROUP to which it belongs is defined in clause 6.5.2.
- iv) The parameter BS\_CCCH\_SDCCH\_COMB in the BCCH (see clause 3.3.2) defines whether the common control channels defined are combined with SDCCH/4(0.3) + SACCH/C4(0.3) onto the same basic physical channel. If they are combined then the number of available random access channel blocks (access grant channel blocks and paging channel blocks; see following), are reduced as defined in table 5 of clause 7.

- v) The PCH, AGCH, and BCCH Ext may share the same TDMA frame mapping (considered modulo 51) when combined onto a basic physical channel. The channels are shared on a block-by-block basis, and information within each block, when de-interleaved and decoded allows a mobile to determine whether the block contains paging messages, system information messages or access grants. However, to ensure a mobile satisfactory access to the system a variable number of the available blocks in each 51-multiframe can be reserved for access grants and system information messages, only. The number of blocks not used for paging (BS\_AG\_BLK\_RES) starting from, and including block number 0 is broadcast in the BCCH (see clause 3.3.2). As above the number of paging blocks per 51-multiframe considered to be "available" shall be reduced by the number of blocks reserved for access grant messages.

If system information messages are sent on BCCH Ext, BS\_AG\_BLK\_RES shall be set to a value greater than zero.

Table 5 of clause 7 defines the access grant blocks and paging blocks available per 51-multiframe.

- vi) Another parameter in the BCCH, BS\_PA\_MFRMS indicates the number of 51-multiframes between transmissions of paging messages to mobiles in idle mode of the same paging group. The "available" paging blocks per CCCH are then those "available" per 51-multiframe on that CCCH (determined by the two above parameters) multiplied by BS\_PA\_MFRMS. Mobiles are normally only required to monitor every Nth block of their paging channel, where N equals the number of "available" blocks in total (determined by the above BCCH parameters) on the paging channel of the specific CCCH which their CCCH\_GROUP is required to monitor. Other paging modes (e.g. page reorganize or paging overload conditions described in 3GPP TS 04.08) may require the mobile to monitor paging blocks more frequently than this. All the mobiles listening to a particular paging block are defined as being in the same PAGING\_GROUP. The method by which a particular mobile determines to which particular PAGING\_GROUP it belongs and hence which particular block of the available blocks on the paging channel is to be monitored is defined in clause 6.5.2.
- viii) In presence of PCCCH, the parameter BS\_PCC\_CHANS in the PBCCH defines the number of physical channels for packet data (PDCH) carrying PCCCH. The (P)BCCH shall in addition indicate the physical description of those channels. Each PCCCH carries its own PCCCH\_GROUP of MSs in GPRS attached mode. MS in a specific PCCCH\_GROUP will listen for paging messages and make random accesses only on the specific PCCCH to which the PCCCH\_GROUP belongs. The method by which an MS determines the PCCCH\_GROUP to which it belongs is defined in clause 6.5.6.
- x) For COMPACT, the base transceiver station shall transmit a burst in a PDCH allocated to carry CPBCCH, in all TDMA Frames where CPBCCH, CFCCCH, CSCH is allocated or where CPPCH can appear. In TDMA Frames where CPPCH can appear on the physical channel where CPBCCH is allocated, the base transceiver station shall transmit a dummy block in case no block is required to be transmitted.
- xi) For COMPACT, a base station does not transmit a burst in every timeslot of every TDMA frame in the downlink of the COMPACT control carrier (i.e. discontinuous transmission is used).
- xii) For COMPACT, inter base station time synchronization is required. Timeslot number (TN) = i (i = 0 to 7) and frame number (FN) with FN mod 208 = 0 shall occur at the same time in all cells.
- xiii) For the primary COMPACT carrier, timeslot numbers (TN) 1, 3, 5, and 7 shall support channel combination xxii) in clause 6.4.1. TNs 0, 2, 4, and 6 shall support channel combination xiii).
- xiv) For the secondary COMPACT carrier(s) carrying CPCCCH, timeslot numbers (TN) 1, 3, 5, and 7 shall support channel combination xxiii) in clause 6.4.1. TNs 0, 2, 4, and 6 shall support channel combination xiii). CPCCCHs on secondary COMPACT carrier(s) shall be allocated on same time group as for primary COMPACT carrier.
- xv) For the secondary COMPACT carrier(s) not carrying CPCCCH, timeslot numbers (TN) 0 through 7 shall support channel combination xiii) in clause 6.4.1.
- xvi) For COMPACT, BS\_PAG\_BLK\_RES shall be less than or equal to 8 and less than or equal to 10-BS\_PBCCH\_BLK.
- xvii) For COMPACT, CFCCCH, CSCH, CPBCCH, and CPCCCH are rotated as described in clause 6.3.2.1. PDTCH, PACCH, and PTCCH do not rotate.
- xviii) For COMPACT, the parameters NIB\_CCCH\_0, NIB\_CCCH\_1, NIB\_CCCH\_2, and NIB\_CCCH\_3 shall not be broadcast for a serving time group.

- xix) For the COMPACT, NIB\_CCCH\_0, NIB\_CCCH\_1, NIB\_CCCH\_2, and NIB\_CCCH\_3 blocks shall be idle for non-serving time groups and rotate in accordance with the non-serving time groups.

The downlink position of the NIB\_CCCH idle blocks is based on the ordered list as defined in clause 6.3.2.1. The MS shall ignore these downlink idle blocks and shall interpret this action as not having detected an assigned USF value on an assigned PDCH.

- xx) For COMPACT large cells, NIB\_CCCH\_0, NIB\_CCCH\_1, NIB\_CCCH\_2, and NIB\_CCCH\_3 blocks shall be idle on timeslots immediately preceding and succeeding non-serving time groups and rotate in accordance with the non-serving time groups. The MS shall ignore these downlink idle blocks and shall interpret this action as not having detected an assigned USF value on an assigned PDCH.

The downlink position of the NIB\_CCCH idle blocks is based on the ordered list as defined in clause 6.3.2.1.

- xxi) For COMPACT, the MS attempts uplink random access on its designated serving time group (TG) by monitoring for USF=FREE in every downlink block.

For dynamic allocation, while in the uplink transfer state, the MS monitors all of the downlink non-idle blocks of its assigned PDCH for uplink assignments. The MS shall ignore downlink idle blocks and shall interpret this action as not having detected an assigned USF value on an assigned PDCH.

USF should be set equal to FREE for downlink non-idle blocks B0 on timeslot numbers (TN) 1, 3, 5, and 7.



Clause 7 Table 1 of 9: Mapping of logical channels onto physical channels (see clauses 6.3, 6.4, 6.5)

Channel designation	Sub-channel number	Direction	Allowable time slot assignments	Allowable RF channel assignments	Burst type	Repeat length in TDMA frames	Interleaved block TDMA frame mapping	
FACCH/F		D&U	0 ... 7	C0 ... Cn	NB <sup>1</sup>	13	B0(0...7),B1(4...11),B2(8...11,0...3)	
FACCH/H	0	U	0 ... 7	C0 ... Cn	NB <sup>1</sup>	26	B0(0,2,4,6,8,10),B1(8,10,13,15,17,19),B2(17,19,21,23,0,2)	
FACCH/H	0	D	0 ... 7	C0 ... Cn	NB <sup>1</sup>	26	B0(4,6,8,10,13,15),B1(13,15,17,19,21,23),B2(21,23,0,2,4,6)	
FACCH/H	1	U	0 ... 7	C0 ... Cn	NB <sup>1</sup>	26	B0(1,3,5,7,9,11),B1(9,11,14,16,18,20),B2(18,20,22,24,1,3)	
FACCH/H	1	D	0 ... 7	C0 ... Cn	NB <sup>1</sup>	26	B0(5,7,9,11,14,16),B1(14,16,18,20,22,24),B2(22,24,1,3,5,7)	
E-FACCH/F		D&U	0 ... 7	C0 ... Cn	NB <sup>1</sup>	13	B0(0...3),B1(4...7),B2(8...11)	
E-IACCH/F		D&U	0 ... 7	C0 ... Cn		26	B0(0 ... 3)B1(4 ... 7)B2(8 ... 11)B3(13 ... 16) B4(17 ... 20)B5(21 ... 24)	
SACCH/TF		D&U <sup>2</sup>	0	C0 ... Cn	NB <sup>3</sup>	104	B(12, 38, 64, 90)	NOTE 1: An Access Burst (AB) is used on the uplink during handover and on channels used for voice group calls when a request to talk is made.
SACCH/TF		D&U <sup>2</sup>	1	C0 ... Cn	NB <sup>3</sup>	104	B(25, 51, 77, 103)	
SACCH/TF		D&U <sup>2</sup>	2	C0 ... Cn	NB <sup>3</sup>	104	B(38, 64, 90, 12)	
SACCH/TF		D&U <sup>2</sup>	3	C0 ... Cn	NB <sup>3</sup>	104	B(51, 77, 103, 25)	
SACCH/TF		D&U <sup>2</sup>	4	C0 ... Cn	NB <sup>3</sup>	104	B(64, 90, 12, 38)	
SACCH/TF		D&U <sup>2</sup>	5	C0 ... Cn	NB <sup>3</sup>	104	B(77, 103, 25, 51)	
SACCH/TF		D&U <sup>2</sup>	6	C0 ... Cn	NB <sup>3</sup>	104	B(90, 12, 38, 64)	
SACCH/TF		D&U <sup>2</sup>	7	C0 ... Cn	NB <sup>3</sup>	104	B(103, 25, 51, 77)	
SACCH/M		D&U <sup>2</sup>	0 ... 7	C0 ... Cn	NB <sup>3</sup>	104	B(12, 38, 64, 90)	
SACCH/TH	0	D&U <sup>2</sup>	0	C0 ... Cn	NB <sup>3</sup>	104	B(12, 38, 64, 90)	NOTE 2: The uplink of a channel used for voice broadcast or a voice group call may actually not be used.
SACCH/TH	1	D&U <sup>2</sup>	0	C0 ... Cn	NB <sup>3</sup>	104	B(25, 51, 77, 103)	
SACCH/TH	0	D&U <sup>2</sup>	1	C0 ... Cn	NB <sup>3</sup>	104	B(12, 38, 64, 90)	
SACCH/TH	1	D&U <sup>2</sup>	1	C0 ... Cn	NB <sup>3</sup>	104	B(25, 51, 77, 103)	
SACCH/TH	0	D&U <sup>2</sup>	2	C0 ... Cn	NB <sup>3</sup>	104	B(38, 64, 90, 12)	
SACCH/TH	1	D&U <sup>2</sup>	2	C0 ... Cn	NB <sup>3</sup>	104	B(51, 77, 103, 25)	
SACCH/TH	0	D&U <sup>2</sup>	3	C0 ... Cn	NB <sup>3</sup>	104	B(38, 64, 90, 12)	
SACCH/TH	1	D&U <sup>2</sup>	3	C0 ... Cn	NB <sup>3</sup>	104	B(51, 77, 103, 25)	
SACCH/TH	0	D&U <sup>2</sup>	4	C0 ... Cn	NB <sup>3</sup>	104	B(64, 90, 12, 38)	
SACCH/TH	1	D&U <sup>2</sup>	4	C0 ... Cn	NB <sup>3</sup>	104	B(77, 103, 25, 51)	NOTE 3: An Access Burst (AB) may be used on the uplink during handover.
SACCH/TH	0	D&U <sup>2</sup>	5	C0 ... Cn	NB <sup>3</sup>	104	B(64, 90, 12, 38)	
SACCH/TH	1	D&U <sup>2</sup>	5	C0 ... Cn	NB <sup>3</sup>	104	B(77, 103, 25, 51)	
SACCH/TH	0	D&U <sup>2</sup>	6	C0 ... Cn	NB <sup>3</sup>	104	B(90, 12, 38, 64)	
SACCH/TH	1	D&U <sup>2</sup>	6	C0 ... Cn	NB <sup>3</sup>	104	B(103, 25, 51, 77)	
SACCH/TH	0	D&U <sup>2</sup>	7	C0 ... Cn	NB <sup>3</sup>	104	B(90, 12, 38, 64) B(103, 25, 51, 77)	

Clause 7 Table 3 of 9: Mapping of logical channels onto physical channels (see clauses 6.3, 6.4, 6.5)

Channel designation	Sub-channel number	Direction	Allowable timeslot assignments	Allowable RF channel assignments	Burst type	Repeat length in TDMA frames	Interleaved block TDMA frame mapping
FCCH		D	0	C0	FB	51	B0(0),B1(10),B2(20),B3(30),B4(40)
SCH		D	0	C0	SB	51	B0(1),B1(11),B2(21),B3(31),B4(41)
BCCH Norm		D	0,2,4,6	C0	NB	51	B(2..5)
BCCH Ext		D	0,2,4,6	C0	NB	51	B(6..9)
PCH AGCH		D	0,2,4,6	C0	NB	51	B0(6..9),B1(12..15),B2(16..19) B3(22..25),B4(26..29),B5(32..35), B6(36..39),B7(42..45),B8(46..49)
RACH		U	0,2,4,6	C0	AB	51	B0(0),B1(1)..B50(50)
CBCH(SDCCH/4)		D	0	C0	NB	51	B(32..35)
CBCH(SDCCH/8)		D	0 ... 3	C0 ... Cn	NB	51	B(8..11)
SDCCH/4	0	D	0	C0	NB <sup>1</sup>	51	B(22..25)
	1	U					B(37..40)
	2	D					B(26..29)
	3	U					B(41..44)
		D					B(32..35)
		U					B(47..50)
		D					B(36..39)
		U					B(0..3)
SACCH/C4	0	D	0	C0	NB <sup>3</sup>	102	B(42..45)
	1	U					B(57..60)
	2	D					B(46..49)
	3	U					B(61..64)
		D					B(93..96)
		U					B(6..9)
		D					B(97..100)
		U					B(10..13)

NOTE 1: An Access Burst (AB) is used on the uplink during handover

NOTE 3: An Access Burst (AB) may be used on the uplink during handover.

Clause 7 Table 4 of 9: Mapping of logical channels onto physical channels (see clauses 6.3, 6.4, 6.5)

Channel designation	Sub-channel number	Direction	Allowable timeslot assignments	Allowable RF channel assignments	Burst type	Repeat length in TDMA frames	Interleaved block TDMA frame mapping
SDCCH/8	0	D	0 ... 7	C0 ... Cn	NB <sup>1</sup>	51	B (0 ... 3)
		U					B (15 ... 18)
	1	D					B (4 ... 7)
		U					B (19 ... 22)
	2	D					B (8 ... 11)
		U					B (23 ... 26)
	3	D					B (12 ... 15)
		U					B (27 ... 30)
	4	D					B (16 ... 19)
		U					B (31 ... 34)
	5	D					B (20 ... 23)
		U					B (35 ... 38)
	6	D					B (24 ... 27)
		U					B (39 ... 42)
7	D	B (28 ... 31)					
	U	B (43 ... 46)					
SACCH/C8	0	D	0 ... 7	C0 ... Cn	NB <sup>3</sup>	102	B (32 ... 35)
		U					B (47 ... 50)
	1	D					B (36 ... 39)
		U					B (51 ... 54)
	2	D					B (40 ... 43)
		U					B (55 ... 58)
	3	D					B (44 ... 47)
		U					B (59 ... 62)
	4	D					B (83 ... 86)
		U					B (98 ... 101)
	5	D					B (87 ... 90)
		U					B (0 ... 3)
	6	D					B (91 ... 94)
		U					B (4 ... 7)
7	D	B (95 ... 98)					
	U	B (8 ... 11)					

NOTE 1: An Access Burst (AB) is used on the uplink during handover.

NOTE 3: An Access Burst (AB) may be used on the uplink during handover.

**Clause 7 Table 5 of 9: Mapping of logical channels onto physical channels (see clauses 6.3, 6.4, 6.5)**

BS_CCCH_SDCCH_COMB		Random access channel blocks available		Access grant blocks available (NOTE: Some access grant blocks may also be used for the NCH)		BS_AG_BLK_RES		Number of paging blocks available per 51-multiframe		Paging channel blocks available (Paging block index = 0, 1, 2, 3, 4, 5, 6, 7, 8)	
False	B0, B1 ... B50	B0, B1 ... B8	0	9	B0, B1, B2, B3, B4, B5, B6, B7, B8						
False			1	8	B1, B2, B3, B4, B5, B6, B7, B8						
False			2	7	B2, B3, B4, B5, B6, B7, B8						
False			3	6	B3, B4, B5, B6, B7, B8						
False			4	5	B4, B5, B6, B7, B8						
False			5	4	B5, B6, B7, B8						
False			6	3	B6, B7, B8						
False			7	2	B7, B8						
True	B4, B5, B14, B15 ... B36, B45, B46	B0, B1, B2	0	3	B0, B1, B2						
True			1	2	B1, B2						
True			2	1	B2						

Clause 7 Table 6 of 9: Mapping of logical channels onto physical channels (see clauses 6.3, 6.4, 6.5)

Channel designation	Sub-channel number	Direction	Allowable time-slot assignment	Allowable RF channel assignment	Burst type	Repeat length in TDMA frames	Interleaved block TDMA frame mapping
PDTCH/F, PACCH/F		D&U	0...7	C0...Cn	NB <sup>1</sup>	52	B0(0...3), B1(4...7), B2(8...11), B3(13...16), B4(17...20), B5(21...24), B6(26...29), B7(30...33), B8(34...37), B9(39...42), B10(43...46), B11(47...50)
PDTCH/H, PACCH/H	0	D&U	0...7	C0... Cn	NB <sup>1</sup>	52	B0(0,2,4,6), B1(8,10,13,15), B2(17,19,21,23), B3(26,28,30,32), B4(34,36,39,41), B5(43,45,47,49)
	1	D&U	0...7	C0...Cn	NB <sup>1</sup>	52	B0(1,3,5,7), B1(9,11,14,16), B2(18,20,22,24), B3(27,29,31,33), B4(35,37,40,42), B5(44,46,48,50)
PBCCH		D	0...7	C0...Cn	NB	52	B0(0... 3), B3(13...16), B6(26...29), B9(39...42)
PRACH		U	0...7	C0...Cn	AB	52	B0(0)...B11(11), B12(13)...B23(24), B24(26)... B35(37), B36(39)...B47(50)
PPCH, PNCH		D	0...7	C0...Cn	NB	52	B1(4 ... 7), B2(8...11), B3(13...16), B4(17...20), B5(21...24), B6(26...29), B7(30...33), B8(34...37), B9(39...42), B10(43...46), B11(47...50)
PAGCH		D	0...7	C0...Cn	NB	52	B0(0...3), B1(4 ... 7), B2(8...11), B3(13...16), B4(17...20), B5(21...24), B6(26...29), B7(30...33), B8(34...37), B9(39...42), B10(43...46), B11(47...50)
PTCCH/D		D	0...7	C0...Cn	NB	416	B0(12,38,64,90), B1(116,142,168,194), B2(220,246,272,298), B3(324,350,376,402)
PTCCH/U	0 1 2 3 4 5 6 7 8 9 10 11 12 13 14 15	U	0...7	C0...Cn	AB	416	B0(12) B0(38) B0(64) B0(90) B0(116) B0(142) B0(168) B0(194) B0(220) B0(246) B0(272) B0(298) B0(324) B0(350) B0(376) B0(402)

NOTE 1: An Access Burst (AB) may be used on the uplink as polling response.

**Clause 7 Table 7 of 9: Mapping of logical channels onto physical channels (see clauses 6.3, 6.4, 6.5)****Non-COMPACT :**

BS_PAG_BLK_RES + BS_PBCCH_BLK		
	Number of paging blocks available per 52-multiframe	
	Paging channel blocks available for 52-multiframe (Paging block index = 0, 1, 2, 3, 4, 5, 6, 7, 8, 9, 10)	
1	11	B1, B2, B3, B4, B5, B6, B7, B8, B9, B10, B11
2	10	B1, B2, B3, B4, B5, B7, B8, B9, B10, B11
3	9	B1, B2, B4, B5, B7, B8, B9, B10, B11
4	8	B1, B2, B4, B5, B7, B8, B10, B11
5	7	B2, B4, B5, B7, B8, B10, B11
6	6	B2, B4, B5, B8, B10, B11
7	5	B2, B5, B8, B10, B11
8	4	B2, B5, B8, B11
9	3	B5, B8, B11
10	2	B5, B11
11	1	B11
>11	0	

**Clause 7 Table 7a of 9: Mapping of logical channels onto physical channels (see clauses 6.3, 6.4, 6.5)**

**COMPACT :**

	<b>BS_PBCCH_BLKs = 1</b>	<b>BS_PBCCH_BLKs = 2</b>
<b>BS_PAG_BLKs_RES</b>	Paging channel blocks available for 52-multiframe (Paging block index = 0, 1, 2, 3, 4, 5, 6, 7, 8, 9, 10)	Paging channel blocks available for 52-multiframe (Paging block index = 0, 1, 2, 3, 4, 5, 6, 7, 8, 9, 10)
0	B1, B2, B3, B4, B5, B6, B7, B8, B9, B10, B11	B1, B2, B3, B4, B5, B7, B8, B9, B10, B11
1	B1, B2, B3, B4, B5, B6, B7, B8, B9, B10	B1, B2, B3, B4, B5, B7, B8, B9, B10
2	B1, B2, B3, B4, B6, B7, B8, B9, B10	B1, B2, B3, B4, B7, B8, B9, B10
3	B1, B2, B3, B4, B6, B7, B9, B10	B1, B2, B3, B4, B7, B9, B10
4	B1, B3, B4, B6, B7, B9, B10	B1, B3, B4, B7, B9, B10
5	B1, B3, B4, B6, B7, B9	B1, B3, B4, B7, B9
6	B1, B3, B6, B7, B9	B1, B3, B7, B9
7	B1, B3, B6, B9	B1, B3, B9
8	B3, B6, B9	B3, B9

	<b>BS_PBCCH_BLKs = 3</b>	<b>BS_PBCCH_BLKs = 4</b>
<b>BS_PAG_BLKs_RES</b>	Paging channel blocks available for 52-multiframe (Paging block index = 0, 1, 2, 3, 4, 5, 6, 7, 8, 9, 10)	Paging channel blocks available for 52-multiframe (Paging block index = 0, 1, 2, 3, 4, 5, 6, 7, 8, 9, 10)
0	B1, B2, B4, B5, B7, B8, B9, B10, B11	B1, B2, B4, B5, B7, B8, B10, B11
1	B1, B2, B4, B5, B7, B8, B9, B10	B1, B2, B4, B5, B7, B8, B10
2	B1, B2, B4, B7, B8, B9, B10	B1, B2, B4, B7, B8, B10
3	B1, B2, B4, B7, B9, B10	B1, B2, B4, B7, B10
4	B1, B4, B7, B9, B10	B1, B4, B7, B10
5	B1, B4, B7, B9	B1, B4, B7
6	B1, B7, B9	B1, B7
7	B1, B9	-
8	-	-

NOTE: In COMPACT, BS\_PAG\_BLKs\_RES shall be less than or equal to 8 and less than or equal to 10 BS\_PBCCH\_BLKs.

Clause 7 Table 9 of 9: Mapping of COMPACT logical channels onto physical channels (see clauses 6.3, 6.4, and 6.5)

Channel Designation	Sub-Channel Number	Direction	Allowable Timeslot Alignment	Allowable RF Channel Assignment	Burst Type	Repeat Length in TDMA Frames	Interleaved Block TDMA Frame Mapping
CFCCH		D	1, 3, 5, 7	C0 ... Cn	FB	52	B0 (25)
CSCH		D	1, 3, 5, 7	C0 ... Cn	SB	52	B0 (51)
CPBCCH		D	1, 3, 5, 7	C0 ... Cn	NB	52	B0 (0 ... 3), B6 (26 ... 29), B3 (13 ... 16), B9 (39 ... 42)
CPRACH		U	1, 3, 5, 7	C0 ... Cn	AB	52	B0 (0) ... B11 (11), B12 (13) ... B23 (24), B24 (26) ... B35 (37), B36 (39) ... B47 (50)
CPAGCH, CPPCH, CPNCH		D	1, 3, 5, 7	C0 ... Cn	NB	52	B1 (4 ... 7), B2 (8 ... 11), B3 (13 ... 16), B4 (17 ... 20), B5 (21 ... 24), B6 (26 ... 29), B7 (30 ... 33), B8 (34 ... 37), B9 (39 ... 42), B10 (43 ... 46), B11 (47 ... 50)



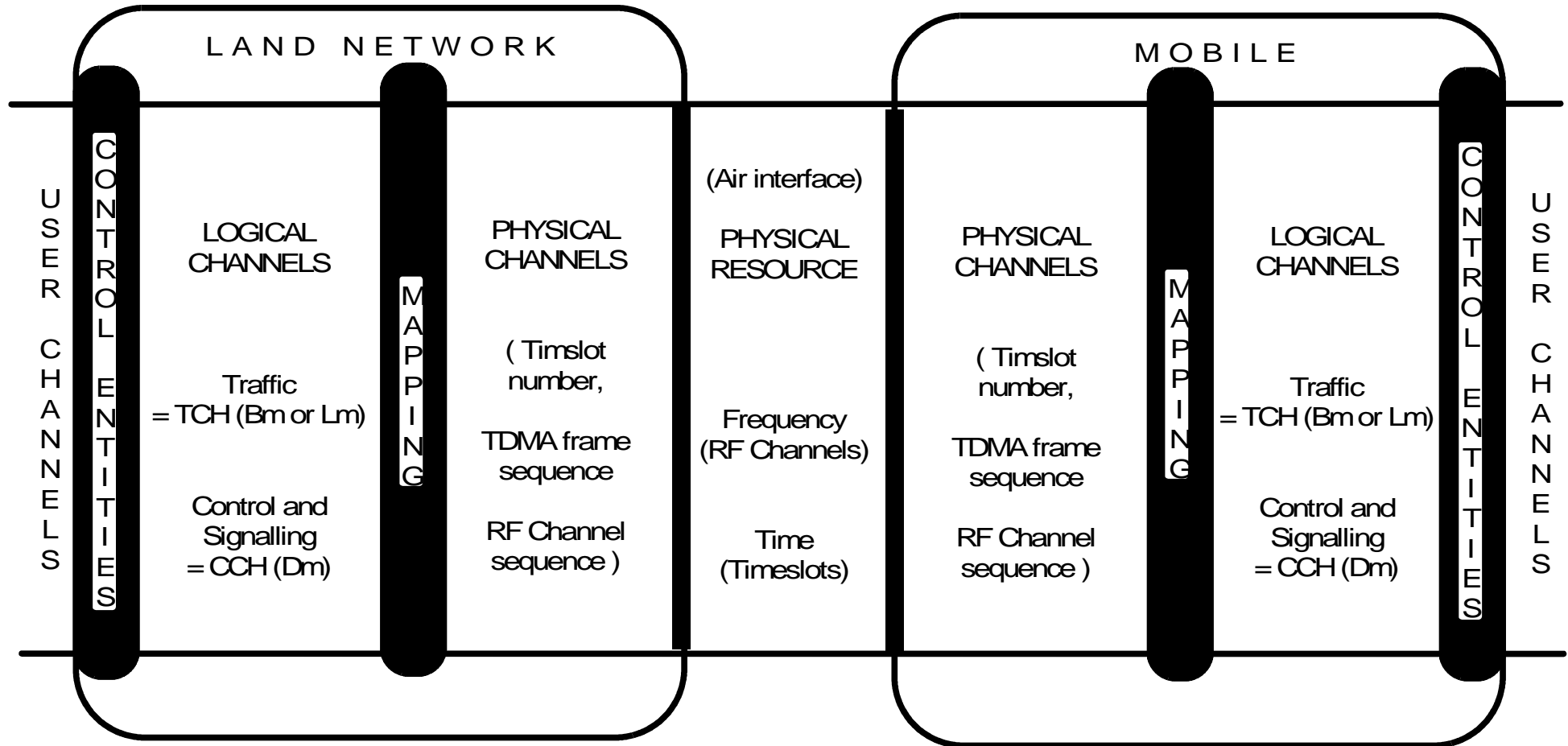

Figure 1: Mapping of logical channels onto physical channels based on the physical resource

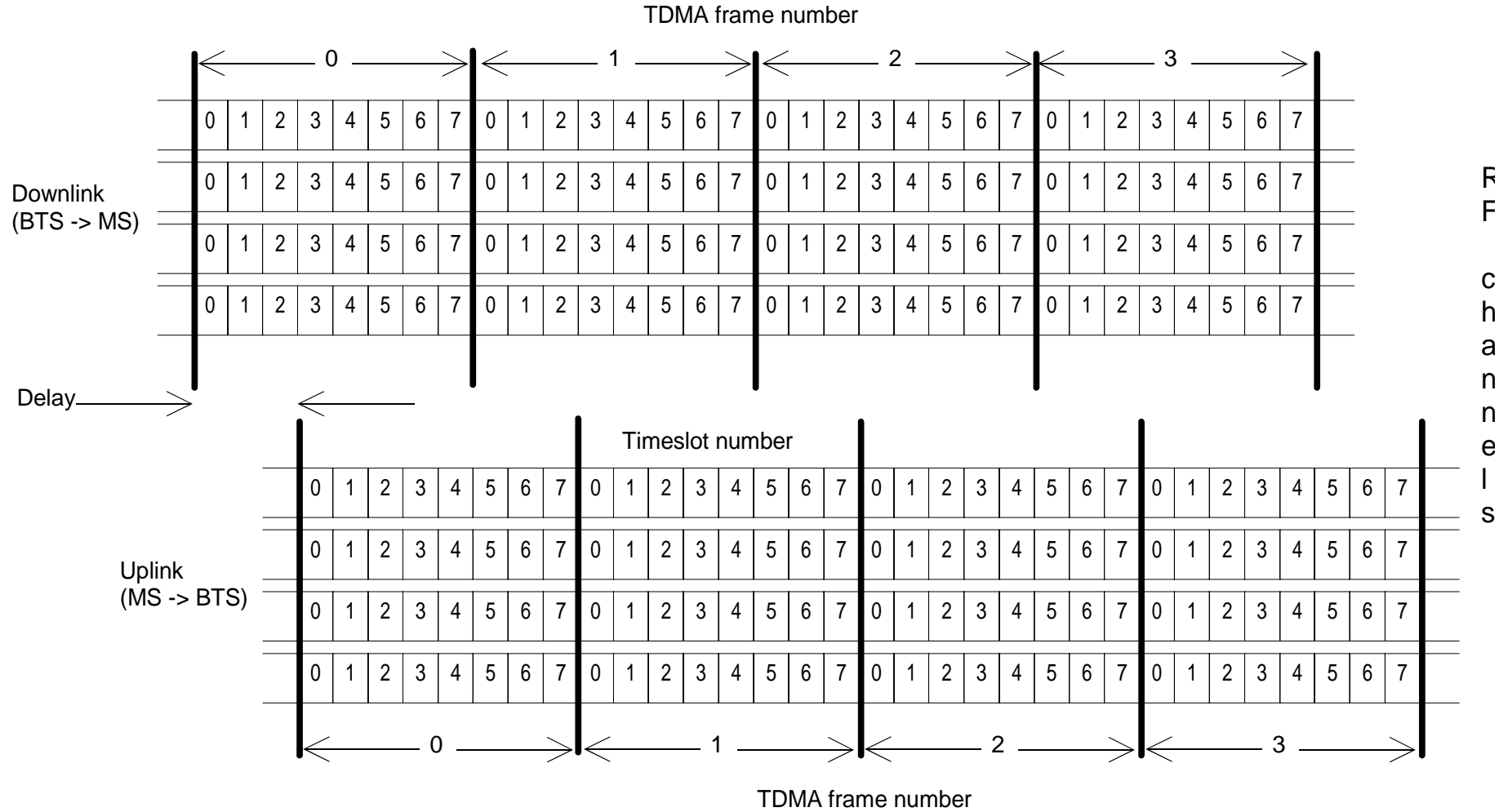

Figure 2: The structure imposed on the physical resource: Timeslots, TDMA Frames and Radio Frequency channels (in this example the cell has an allocation of 4 RF Channels pairs)

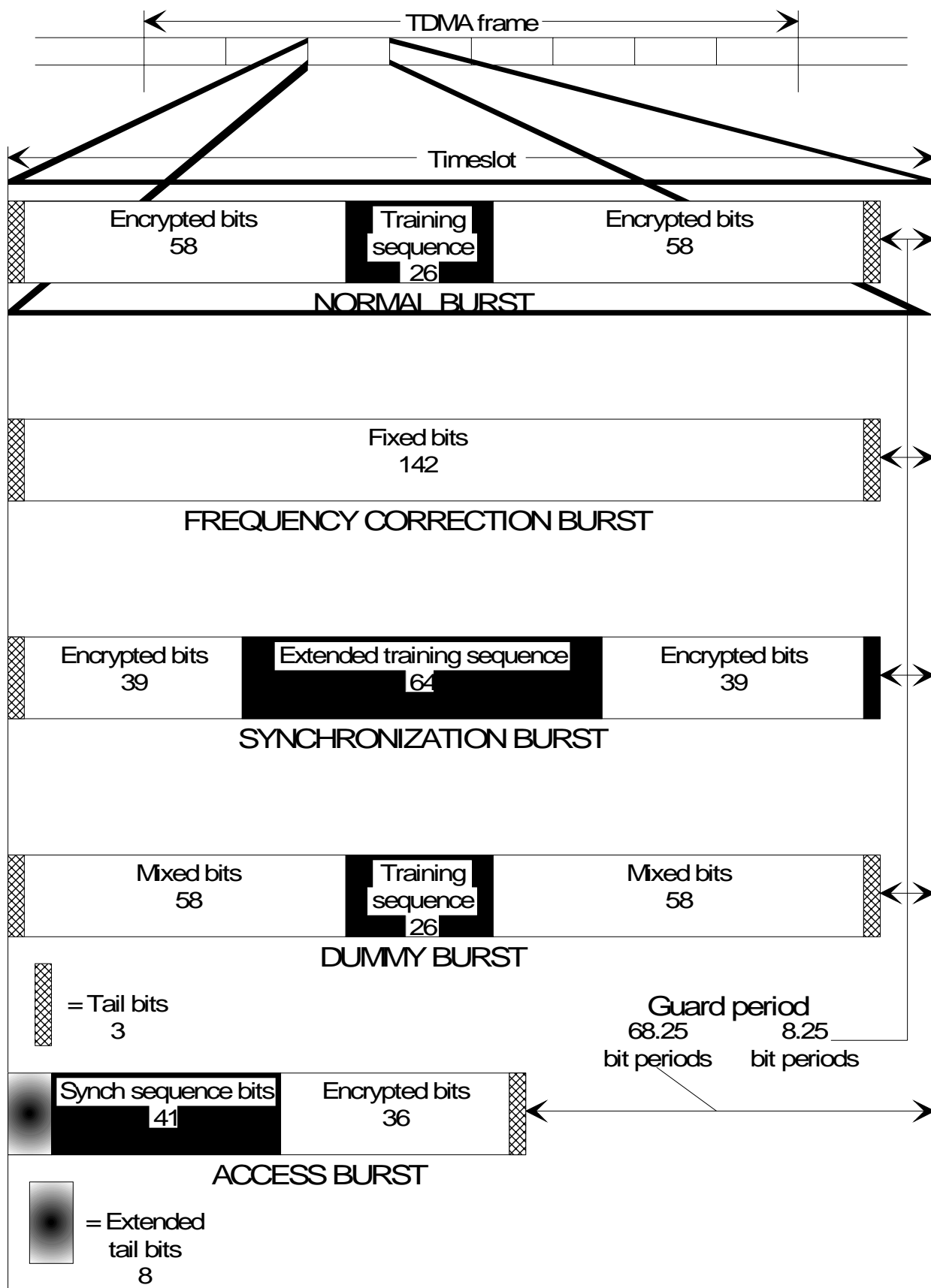
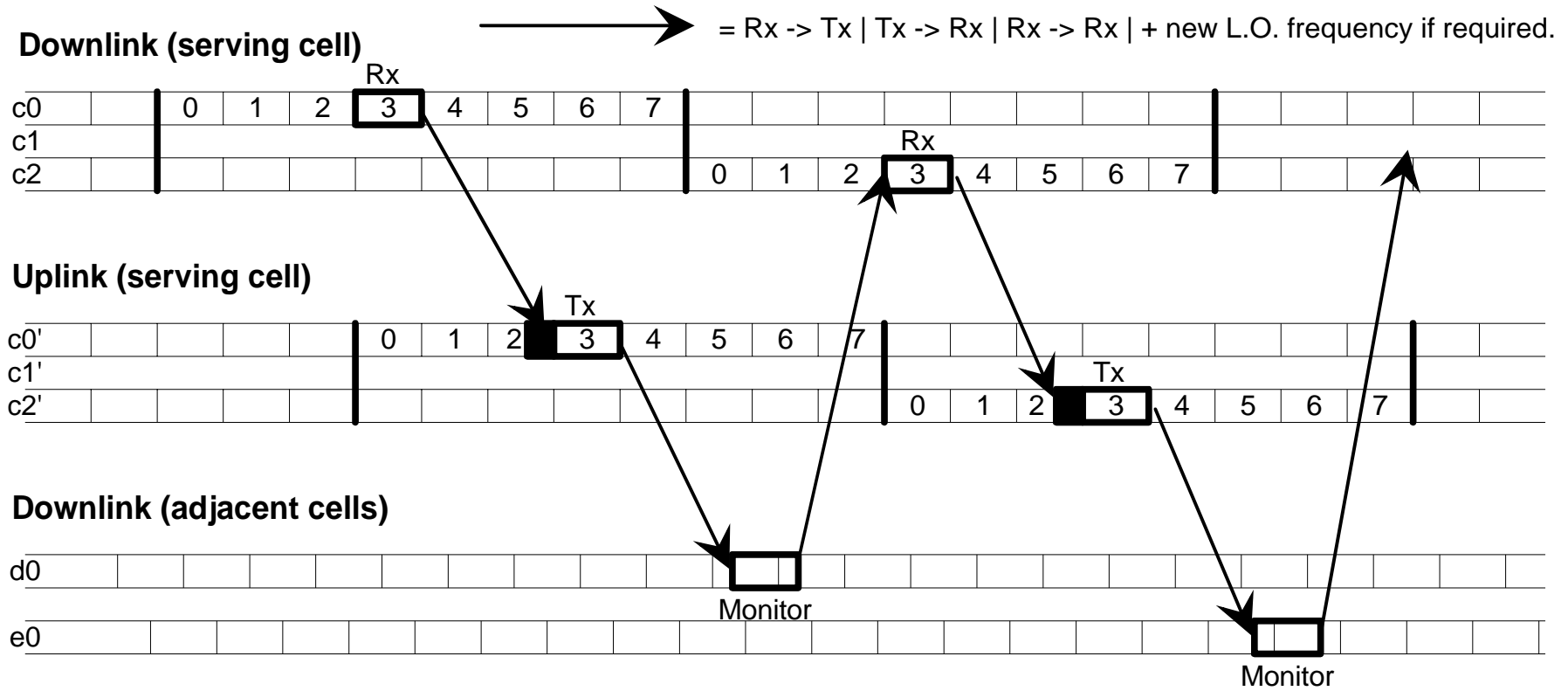
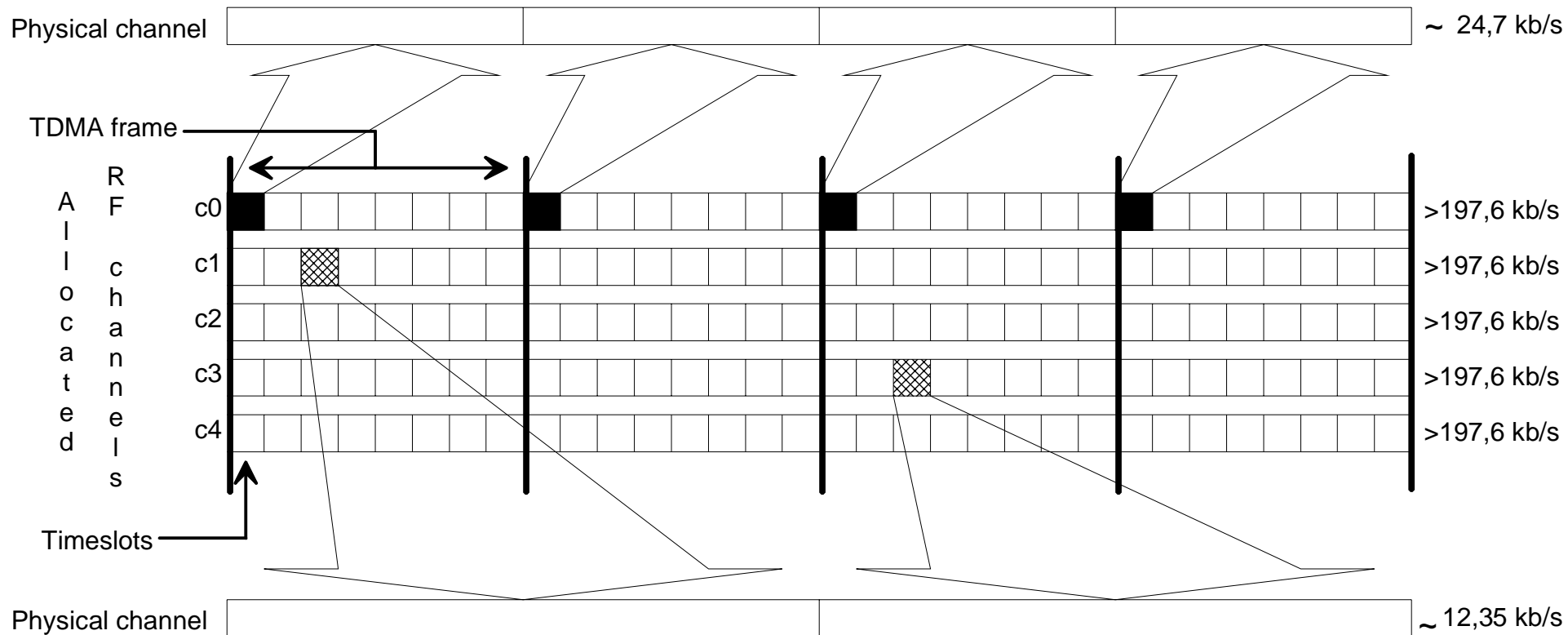

Figure 3: Timeslot and format of bursts



(This example of a physical channel is non-hopping using timeslot 0 of every TDMA frame)

Figure 4: Mobile Station usage of physical channel timeslots (for a full-rate hopping traffic channel assigned timeslot 3)



(This example of a physical channel is hopping using 3 of every other TDMA frame)

Figure 5: Example of two different physical channels

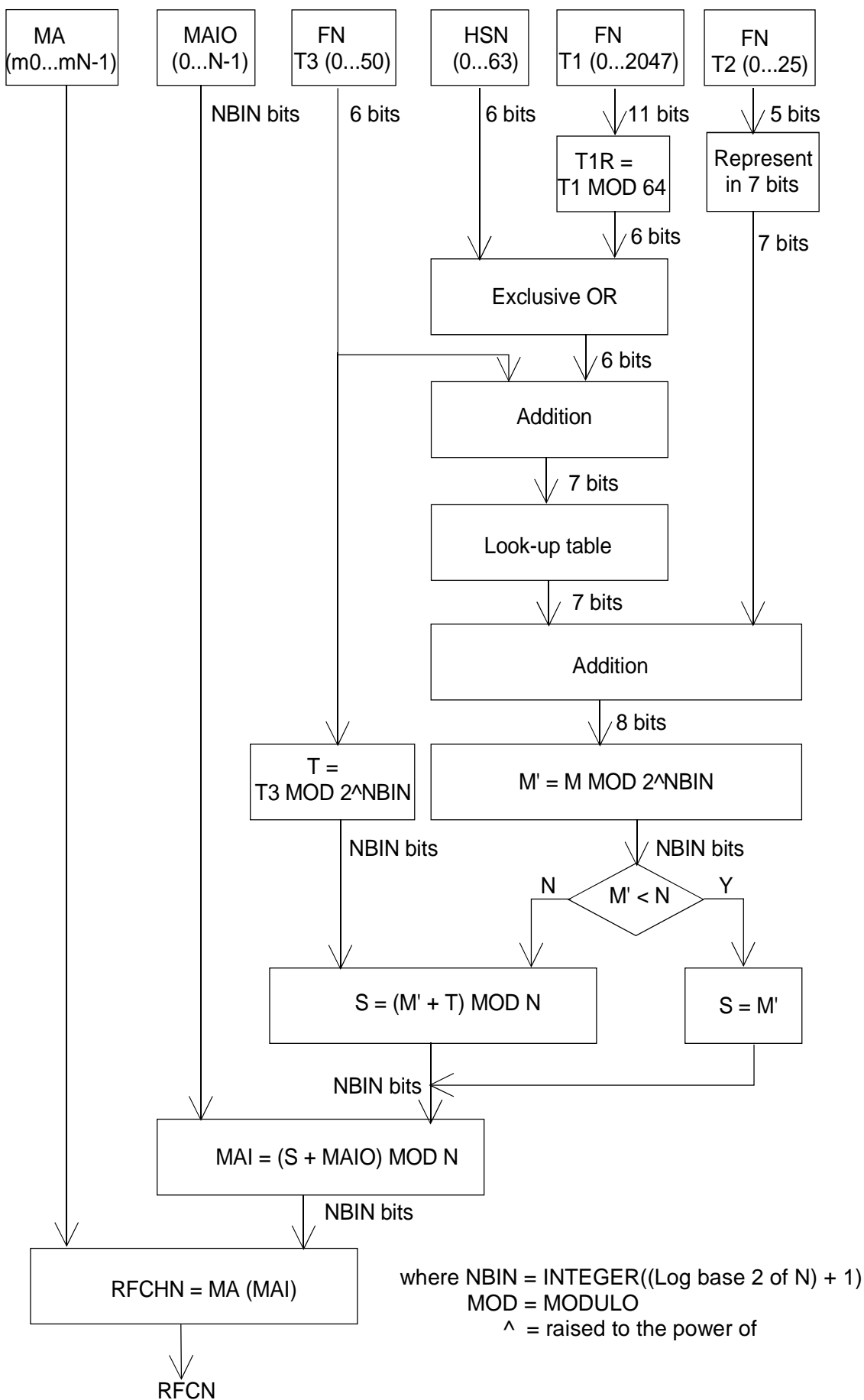
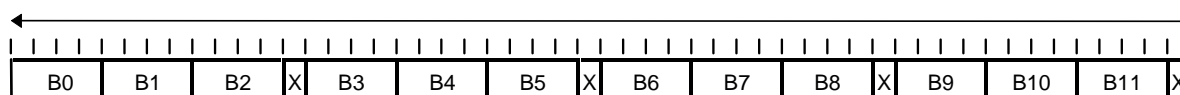

Figure 6: Block diagram of the frequency hopping algorithm when HSN ≠ 0



## 52 TDMA Frames



X = Idle frame  
B0 - B11 = Radio blocks

Figure 9: 52-multiframe for PDCHs -

## B.1 MS classes for multislots capability

When an MS supports the use of multiple timeslots it shall belong to a multislots class as defined below:

Table B.1

Multislots class	Maximum number of slots			Minimum number of slots				Type
	Rx	Tx	Sum	T <sub>ta</sub>	T <sub>tb</sub>	T <sub>ra</sub>	T <sub>rb</sub>	
1	1	1	2	3	2	4	2	1
2	2	1	3	3	2	3	1	1
3	2	2	3	3	2	3	1	1
4	3	1	4	3	1	3	1	1
5	2	2	4	3	1	3	1	1
6	3	2	4	3	1	3	1	1
7	3	3	4	3	1	3	1	1
8	4	1	5	3	1	2	1	1
9	3	2	5	3	1	2	1	1
10	4	2	5	3	1	2	1	1
11	4	3	5	3	1	2	1	1
12	4	4	5	2	1	2	1	1
13	3	3	N/A	N/A	a)	3	a)	2
14	4	4	N/A	N/A	a)	3	a)	2
15	5	5	N/A	N/A	a)	3	a)	2
16	6	6	N/A	N/A	a)	2	a)	2
17	7	7	N/A	N/A	a)	1	0	2
18	8	8	N/A	N/A	0	0	0	2
19	6	2	N/A	3	b)	2	c)	1
20	6	3	N/A	3	b)	2	c)	1
21	6	4	N/A	3	b)	2	c)	1
22	6	4	N/A	2	b)	2	c)	1
23	6	6	N/A	2	b)	2	c)	1
24	8	2	N/A	3	b)	2	c)	1
25	8	3	N/A	3	b)	2	c)	1
26	8	4	N/A	3	b)	2	c)	1
27	8	4	N/A	2	b)	2	c)	1
28	8	6	N/A	2	b)	2	c)	1
29	8	8	N/A	2	b)	2	c)	1

- a) = 1 with frequency hopping.  
= 0 without frequency hopping.
- b) = 1 with frequency hopping or change from Rx to Tx.  
= 0 without frequency hopping and no change from Rx to Tx.
- c) = 1 with frequency hopping or change from Tx to Rx.  
= 0 without frequency hopping and no change from Tx to Rx.

Type 1 MS are not required to transmit and receive at the same time.



Type 2 MS are required to be able to transmit and receive at the same time.

**Rx:**

Rx describes the maximum number of receive timeslots that the MS can use per TDMA frame. The MS must be able to support all integer values of receive TS from 0 to Rx (depending on the services supported by the MS). The receive TS need not be contiguous. For type 1 MS, the receive TS shall be allocated within window of size Rx, and no transmit TS shall occur between receive TS within a TDMA frame.

**Tx:**

Tx describes the maximum number of transmit timeslots that the MS can use per TDMA frame. The MS must be able to support all integer values of transmit TS from 0 to Tx (depending on the services supported by the MS). The transmit TS need not be contiguous. For type 1 MS, the transmit TS shall be allocated within window of size Tx, and no receive TS shall occur between transmit TS within a TDMA frame.

**Sum:**

Sum is the total number of uplink and downlink TS that can actually be used by the MS per TDMA frame. The MS must be able to support all combinations of integer values of Rx and Tx TS where  $1 \leq Rx + Tx \leq Sum$  (depending on the services supported by the MS). Sum is not applicable to all classes.

**T<sub>ta</sub>:**

T<sub>ta</sub> relates to the time needed for the MS to perform adjacent cell signal level measurement and get ready to transmit.

For type 1 MS it is the minimum number of timeslots that will be allowed between the end of the previous transmit or receive TS and the next transmit TS when measurement is to be performed between. It should be noted that, in practice, the minimum time allowed may be reduced by amount of timing advance.

For type 1 MS that supports extended TA, the parameter T<sub>ta</sub> is increased by 1 if TA > 63 and there is a change from RX to TX.

For type 2 MS it is not applicable.

**T<sub>tb</sub>:**

T<sub>tb</sub> relates to the time needed for the MS to get ready to transmit. This minimum requirement will only be used when adjacent cell power measurements are not required by the service selected.

For type 1 MS it is the minimum number of timeslots that will be allowed between the end of the last previous receive TS and the first next transmit TS or between the previous transmit TS and the next transmit TS when the frequency is changed in between. It should be noted that, in practice, the minimum time allowed may be reduced by the amount of the timing advance.

For type 1 MS that supports extended TA, the parameter T<sub>tb</sub> = 2 if TA > 63 and there is a change from RX to TX.

For type 2 MS it is the minimum number of timeslots that will be allowed between the end of the last transmit burst in a TDMA frame and the first transmit burst in the next TDMA frame.

**T<sub>ra</sub>:**

T<sub>ra</sub> relates to the time needed for the MS to perform adjacent cell signal level measurement and get ready to receive.

For type 1 MS it is the minimum number of timeslots that will be allowed between the previous transmit or receive TS and the next receive TS when measurement is to be performed between.

For type 2 MS it is the minimum number of timeslots that will be allowed between the end of the last receive burst in a TDMA frame and the first receive burst in the next TDMA frame.

**T<sub>rb</sub>:**

T<sub>rb</sub> relates to the time needed for the MS to get ready to receive. This minimum requirement will only be used when adjacent cell power measurements are not required by the service selected.

For type 1 MS it is the minimum number of timeslots that will be allowed between the previous transmit TS and the next receive TS or between the previous receive TS and the next receive TS when the frequency is changed in between.

For type 2 MS it is the minimum number of timeslots that will be allowed between the end of the last receive burst in a TDMA frame and the first receive burst in the next TDMA frame.

---

## B.2 Constraints imposed by the service selected

The service selected will impose certain restrictions on the allowed combinations of transmit and receive timeslots. Such restrictions are not imposed by this annex but should be derived from the description of the services. The service selected will determine whether or not adjacent cell power measurements are required and therefore whether T<sub>ra</sub> or T<sub>rb</sub> is allowed for.

---

## B.3 Network requirements for supporting MS multislot classes

The multislot class of the MS will limit the combinations and configurations allowed when supporting multislot communication.

GSM/TETRA 400 network may support extended cell coverage utilizing timing advance values greater than 63. This has an effect that the time for MS to change from RX to TX will be very short for distant MS. It is necessary for the network to decide whether requested or current multislot configuration can be supported by distant MS. If actual TA is great enough it may be necessary for network to downgrade requested resources or it may be necessary for network to downgrade current resources.

It is necessary for the network to decide whether the MS needs to perform adjacent cell power measurement for the type of multislot communication intended and whether the service imposes any other constraints before the full restrictions on TS assignments can be resolved. The service itself may determine that asymmetry must be downlink biased, in which case the last two solutions would not be allowed.

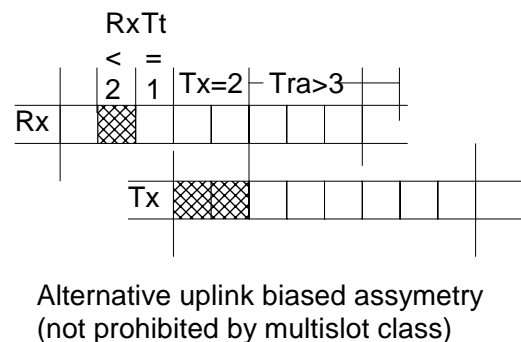
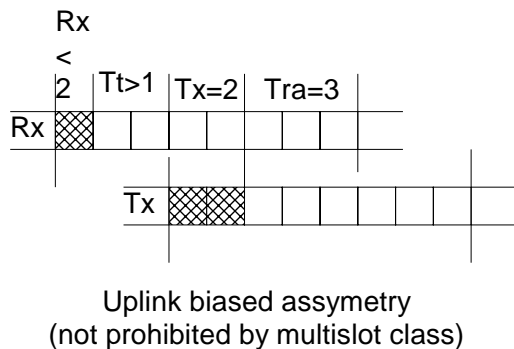
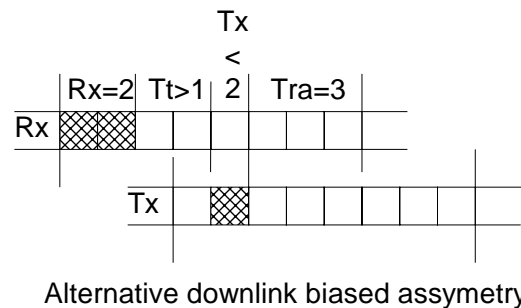
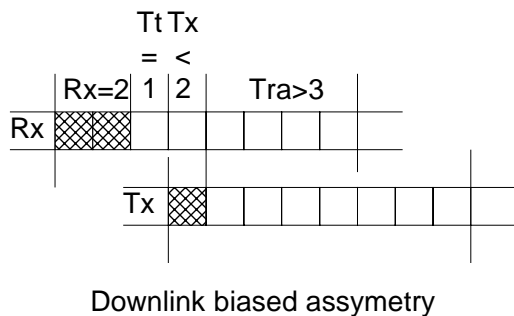
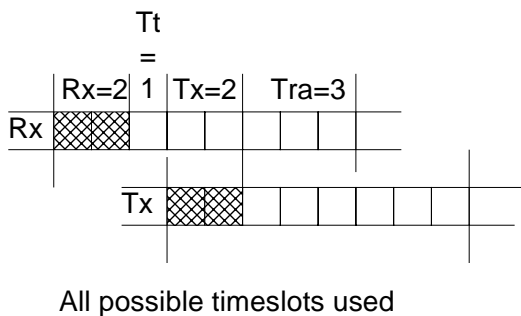

These five combinations can be repeated at the six other positions that can be fitted so within the same TDMA frame

Figure B.1

For a multislot class 13 MS when adjacent cell power measurements are not required and the service does not constrain the transmit and receive timeslots to use the same timeslot number. Many configurations of channels are possible so long as the 5 constraints of the MS are catered for. [Currently services envisaged only allow for the last example here.]

---

## Annex E (normative): Modifications to GSM 05.03

This annex details the modified clauses of GSM 05.03 which are applicable to TAPS.

All references to other GSM standards and specifications are to the standards as modified by the present document.

Where the following channel names appear in diagrams, they should be treated as if they had been deleted.

- CTSARCH
- CTSAGCH
- CTSBCH
- CTSPCH
- TCH/EF
- TCH/AFS
- TCH/AHS
- TCH/HS
- TCH/EFS
- TCH/AF
- TCH/AH
- TCH/FS
- E-TCH/F followed by a data rate
- TCH/F followed by a data rate
- TCH/H followed by a data rate
- HSCSD
- ECSD
- NCH

The following clauses have the same numbering as in 05.03. They are not given additional numbers here as to do so would confuse the reader.

### 2.1 General organization

Each channel has its own coding and interleaving scheme. However, the channel coding and interleaving is organized in such a way as to allow, as much as possible, a unified decoder structure.

Each channel uses the following sequence and order of operations:

- the information bits are coded with a systematic block code, building words of information + parity bits;
- these information + parity bits are encoded with a convolutional code, building the coded bits;
- reordering and interleaving the coded bits, and adding a stealing flag, gives the interleaved bits.

All these operations are made block by block, the size of which depends on the channel. However, most of the channels use a block of 456 coded bits which is interleaved and mapped onto bursts in a very similar way for all of them. Figures 1a and 1b give a diagram showing the general structure of the channel coding.

This block of 456 coded bits is the basic structure of the channel coding scheme. In case of control channels, it carries one message.

In the case of a packet switched channel the block of 456 or 1384 coded bits carries one radio block.

In the case of FACCH, a coded message block of 456 bits is divided into eight sub-blocks. The first four sub-blocks are sent by stealing the even numbered bits of four timeslots in consecutive frames used for the TCH. The other four sub-blocks are sent by stealing the odd numbered bits of the relevant timeslot in four consecutive used frames delayed 2 or 4 frames relative to the first frame. Along with each block of 456 coded bits there is, in addition, a stealing flag (8 bits), indicating whether the block belongs to the TCH or to the FACCH. In the case of SACCH, BCCH, CCCH or CTSCCH, this stealing flag is dummy. In the case of a packet switched channel, these bits are used to indicate the coding scheme used.

In the case of E-FACCH/F, a coded message block of 456 bits is divided into four sub-blocks. The four sub-blocks are sent by stealing all symbols of four timeslots in consecutive frames used for the E-TCH and using GMSK modulation. The indication of the E-FACCH/F is based on the identification of the modulation. Along with each block of 456 coded bits there is, in addition, a stealing flag (8 bits), indicating whether the block belongs to the E-FACCH, FACCH or TCH.

Some cases do not fit in the general organization, and use short blocks of coded bits which are sent completely in one timeslot. They are the random access messages of:

- the RACH;
- or PRACH and CPRACH;

on uplink and the synchronization information broadcast on the SCH or CSCH on the downlink.

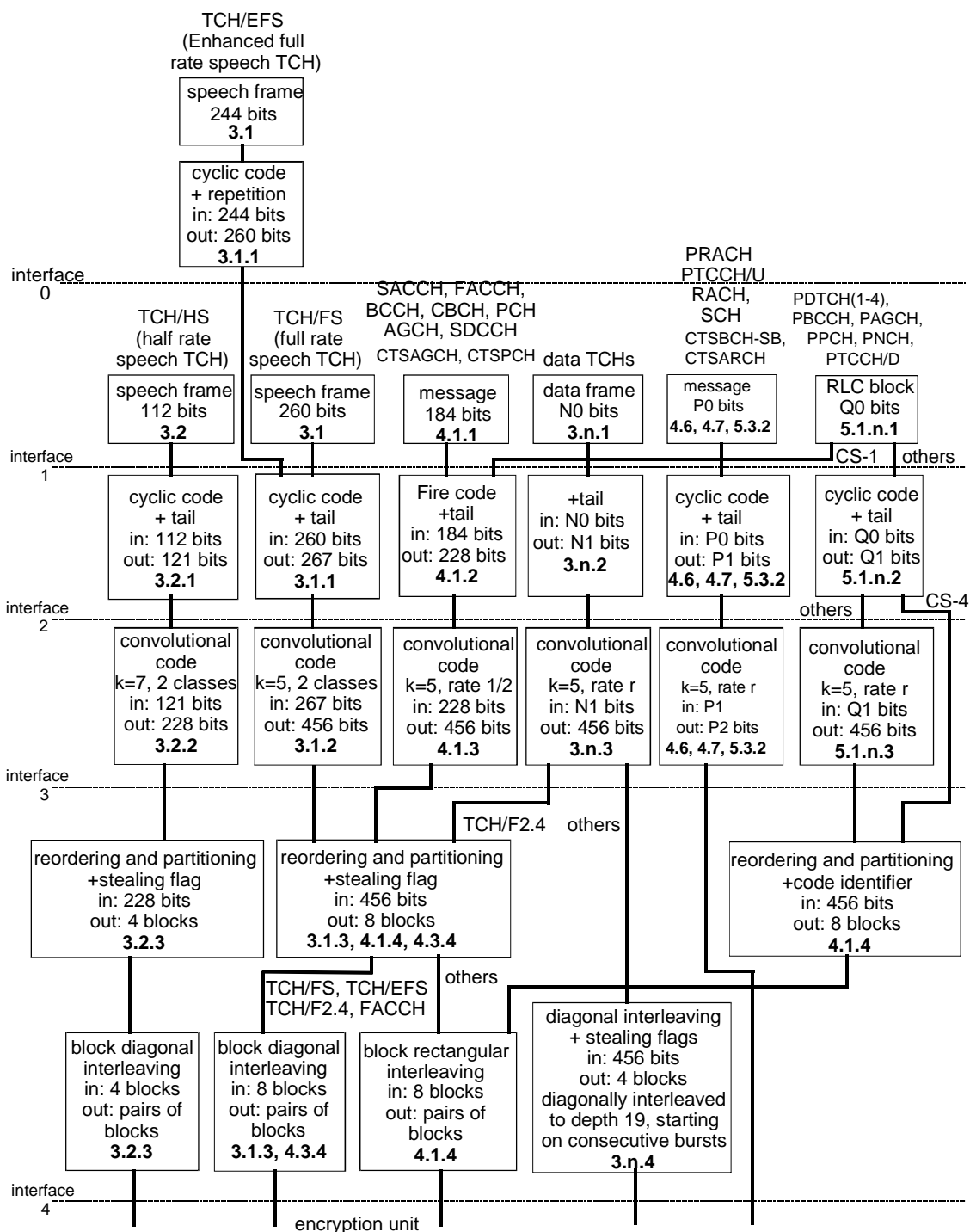

**Figure 1a: Channel Coding and Interleaving Organization**

In each box, the last line indicates the chapter defining the function. In the case of RACH, P0 = 8 and P1 = 18; in the case of Stand CSCH, P0 = 25 and P1 = 39.

Interfaces:

- 1) information bits (d);
- 2) information + parity + tail bits (u);
- 3) coded bits (c);
- 4) interleaved bits (e).

TCH/AHS

TCH/AF

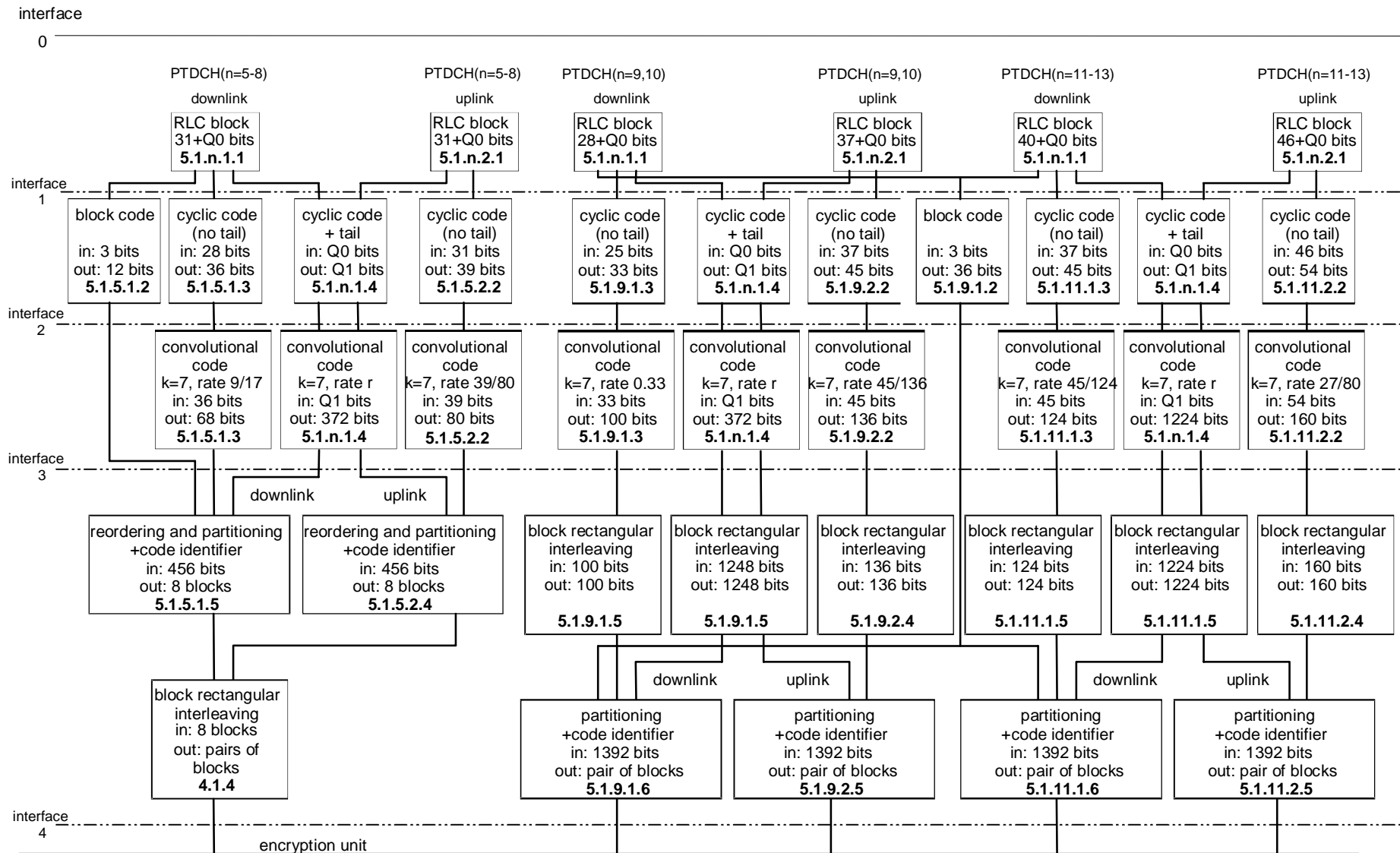

Figure 2b: Channel Coding and Interleaving Organization for EGPRS Packet Data Channel

In each box, the last line indicates the chapter defining the function.

## 2.2 Naming Convention

For ease of understanding a naming convention for bits is given for use throughout the technical specification:

- General naming:

"k" and "j" for numbering of bits in data blocks and bursts;

"K<sub>x</sub>" gives the amount of bits in one block, where "x" refers to the data type;

"n" is used for numbering of delivered data blocks where:

"N" marks a certain data block;

"B" is used for numbering of bursts or blocks where:

"B<sub>0</sub>" marks the first burst or block carrying bits from the data block with n = 0 (first data block in the transmission).

- Data bits delivered to the encoding unit (interface 1 in figure 1):

$d(k)$  for  $k = 0, 1, \dots, K_d - 1$

- Data symbols delivered to the encoding unit:

$D(k)$  for  $k = 0, 1, \dots, K_D - 1$

$k = 0, 1, \dots, 15$  TCH/AMR, SID frames

- Code identifying the used coding scheme (for packet switched channels only):

$q(k)$  for  $k = 0, 1, \dots, 7$

- Data bits after the first encoding step (block code, cyclic code; interface 2 in figure 1):

$u(k)$  for  $k = 0, 1, \dots, K_u - 1$

- Data symbols after the first encoding step (block code):

$U(k)$  for  $k = 0, 1, \dots, K_U - 1$

- Data put into the shift register of the convolutional code and calculated from the data bits  $u(k)$  and the feedback bits in recursive systematic convolutional codes:

$r(k)$  for  $k = 0, 1, \dots, K_r - 1$

- Data after the second encoding step (convolutional code ; interface 3 in figure 1):

$c(n,k)$  or  $c(k)$  for  $k = 0, 1, \dots, K_c - 1$

$n = 0, 1, \dots, N, N+1, \dots$

- Interleaved data bits:

$i(B,k)$  for  $k = 0, 1, \dots, K_i - 1$

$B = B_0, B_0+1, \dots$

- Interleaved data symbols:

$I(B,k)$  for  $k = 0, 1, \dots, K_I - 1$

$B = B_0, B_0+1, \dots$



- Bits in one burst (interface 4 in figure 1):

$$e(B,k) \quad \text{for } k = 0,1,\dots,114,115$$

$$B = B_0, B_0+1, \dots$$

- Symbols in one burst (interface 4 in figure 2):

$$E(B,k) \quad \text{for } k = 0,1,\dots,114,115$$

$$B = B_0, B_0+1, \dots$$

### 4.1.3 Convolutional encoder

This block of 228 bits is encoded with the 1/2 rate convolutional code defined by the polynomials:

$$G_0 = 1 + D^3 + D^4$$

$$G_1 = 1 + D + D^3 + D^4$$

This results in a block of 456 coded bits:  $\{c(0), c(1), \dots, c(455)\}$  defined by:

$$c(2k) = u(k) + u(k-3) + u(k-4)$$

$$c(2k+1) = u(k) + u(k-1) + u(k-3) + u(k-4) \quad \text{for } k = 0,1,\dots,227; u(k) = 0 \text{ for } k < 0$$

### 4.1.4 Interleaving

The coded bits are reordered and interleaved according to the following rule:

$$i(B,j) = c(n,k) \quad \text{for } k = 0,1,\dots,455$$

$$n = 0,1,\dots,N,N+1,\dots$$

$$B = B_0 + 4n + (k \bmod 4)$$

$$j = 2((49k) \bmod 57) + ((k \bmod 8) \text{ div } 4)$$

See table 1. The result of the reordering of bits is a distribution of the 456 bits over 4 blocks on even numbered bits and 4 blocks on odd numbered bits. The resulting 4 blocks are built by putting blocks with even numbered bits and blocks with odd numbered bits together into one block.

The block of coded data is interleaved "block rectangular" where a new data block starts every 4th block and is distributed over 4 blocks.

### 4.2.4 Interleaving

The interleaving is done as follows.

The coded bits are reordered and interleaved according to the following rule:

$$i(B,j) = c(n,k), \quad \text{for } k = 0,1,\dots,455$$

$$n = 0,1,\dots,N,N+1,\dots$$

$$B = B_0 + 4n + (k \bmod 8)$$

$$j = 2((49k) \bmod 57) + ((k \bmod 8) \text{ div } 4)$$

See table 1. The result of the interleaving is a distribution of the reordered 456 bits of a given data block,  $n = N$ , over 8 blocks using the even numbered bits of the first 4 blocks ( $B = B_0 + 4N + 0, 1, 2, 3$ ) and odd numbered bits of the last 4 blocks ( $B = B_0 + 4N + 4, 5, 6, 7$ ). The reordered bits of the following data block,  $n = N+1$ , use the even numbered bits of the blocks  $B = B_0 + 4N + 4, 5, 6, 7$  ( $B = B_0 + 4(N+1) + 0, 1, 2, 3$ ) and the odd numbered bits of the blocks  $B = B_0 + 4(N+1) + 4, 5, 6, 7$ . Continuing with the next data blocks shows that one block always carries 57 bits of data from one data block ( $n = N$ ) and 57 bits of data from the next block ( $n = N+1$ ), where the bits from the data block with the higher number always are the even numbered data bits, and those of the data block with the lower number are the odd numbered bits.

The block of coded data is interleaved "block diagonal", where a new data block starts every 4th block and is distributed over 8 blocks.

## 4.2.5 Mapping on a Burst

A FACCH/F frame of 456 coded bits is mapped on 8 consecutive bursts as specified for the TCH/FS in clause 3.1.4.

As a FACCH is transmitted on bits which are stolen in a burst from the traffic channel, the even numbered bits in the first 4 bursts and the odd numbered bits of the last 4 bursts are stolen.

To indicate this to the receiving device the flags  $hl(B)$  and  $hu(B)$  have to be set according to the following rule:

$hu(B) = 1$  for the first 4 bursts (even numbered bits are stolen);

$hl(B) = 1$  for the last 4 bursts (odd numbered bits are stolen).

NOTE: In the case of consecutive stolen frames, a number of bursts will have both the even and the odd bits stolen and both flags  $hu(B)$  and  $hl(B)$  must be set to 1.

## 4.3.4 Interleaving

The coded bits are reordered and interleaved according to the following rule:

$$i(B,j) = c(n,k) \quad \text{for} \quad k = 0,1,\dots,455$$

$$n = 0,1,\dots,N,N+1,\dots$$

$$B = B_0 + 4n + (k \bmod 8) - 4((k \bmod 8) \text{ div } 6)$$

$$j = 2((49k) \bmod 57) + ((k \bmod 8) \text{ div } 4)$$

See table 1. The result of the reordering of bits is a distribution of the 456 bits over 4 blocks on even numbered bits and 4 blocks on odd numbered bits. The 2 last blocks with even numbered bits and the 2 last blocks with odd numbered bits are put together into 2 full middle blocks.

The block of coded data is interleaved "block diagonal" where a new data block starts every 4th block and is distributed over 6 blocks.

## 4.3.5 Mapping on a Burst

A FACCH/H frame of 456 coded bits is mapped on 6 consecutive bursts by the rule:

$$e(B,j) = i(B,j) \quad \text{and} \quad e(B,59+j) = i(B,57+j) \quad \text{for } j = 0,1,\dots,56$$

and

$$e(B,57) = hl(B) \quad \text{and} \quad e(B,58) = hu(B)$$

As a FACCH/H is transmitted on bits which are stolen from the traffic channel, the even numbered bits of the first 2 bursts, all bits of the middle 2 bursts and the odd numbered bits of the last 2 bursts are stolen.

To indicate this to the receiving device the flags  $hl(B)$  and  $hu(B)$  have to be set according to the following rule:

$$hu(B) = 1 \quad \text{for the first 2 bursts (even numbered bits are stolen)}$$

$hu(B) = 1$  and  $hl(B) = 1$  for the middle 2 bursts (all bits are stolen)

$hl(B) = 1$  for the last 2 bursts (odd numbered bits are stolen)

NOTE: In the case of consecutive stolen frames, two overlapping bursts will have both the even and the odd numbered bits stolen and both flags  $hu(B)$  and  $hl(B)$  must be set to 1.

## 4.4 Broadcast control, Paging, Access grant, Notification and Cell broadcast channels (BCCH, PCH, AGCH, CBCH),

The coding scheme used for the broadcast control, paging, access grant, notification and cell broadcast messages is the same as for the SACCH messages, specified in clause 4.1.

## 4.6 Random access channel (RACH)

The burst carrying the random access uplink message has a different structure. It contains 8 information bits  $d(0), d(1), \dots, d(7)$ .

Six parity bits  $p(0), p(1), \dots, p(5)$  are defined in such a way that in  $GF(2)$  the binary polynomial:

$$d(0)D^{13} + \dots + d(7)D^6 + p(0)D^5 + \dots + p(5), \text{ when divided by } D^6 + D^5 + D^3 + D^2 + D + 1 \text{ yields a remainder equal to } D^5 + D^4 + D^3 + D^2 + D + 1.$$

The six bits of the BSIC,  $\{B(0), B(1), \dots, B(5)\}$ , of the BS to which the Random Access is intended, are added bitwise modulo 2 to the six parity bits,  $\{p(0), p(1), \dots, p(5)\}$ . This results in six colour bits,  $C(0)$  to  $C(5)$  defined as  $C(k) = b(k) + p(k)$  ( $k = 0$  to  $5$ ) where:

$b(0) = \text{MSB of PLMN colour code}$

$b(5) = \text{LSB of BS colour code.}$

This defines  $\{u(0), u(1), \dots, u(17)\}$  by:

$$u(k) = d(k) \quad \text{for } k = 0, 1, \dots, 7$$

$$u(k) = C(k-8) \quad \text{for } k = 8, 9, \dots, 13$$

$$u(k) = 0 \quad \text{for } k = 14, 15, 16, 17 \text{ (tail bits)}$$

The bits  $\{e(0), e(1), \dots, e(35)\}$  are obtained by the convolutional code of rate 1/2, defined by the polynomials:

$$G_0 = 1 + D^3 + D^4$$

$$G_1 = 1 + D + D^3 + D^4$$

and with:

$$e(2k) = u(k) + u(k-3) + u(k-4)$$

$$e(2k+1) = u(k) + u(k-1) + u(k-3) + u(k-4) \quad \text{for } k = 0, 1, \dots, 17; u(k) = 0 \text{ for } k < 0$$

## 4.7 Synchronization channel (SCH), Compact synchronization channel (CSCH),

The burst carrying the synchronization information on the downlink BCCH, the downlink and CPBCCH for Compact, has a different structure. It contains 25 information bits  $\{d(0), d(1), \dots, d(24)\}$ , 10 parity bits  $\{p(0), p(1), \dots, p(9)\}$  and 4 tail bits. The precise ordering of the information bits is given in GSM 04.08.

The ten parity bits  $\{p(0),p(1),\dots,p(9)\}$  are defined in such a way that in GF(2) the binary polynomial:

$$d(0)D^{34} + \dots + d(24)D^{10} + p(0)D^9 + \dots + p(9), \text{ when divided by:}$$

$$D^{10} + D^8 + D^6 + D^5 + D^4 + D^2 + 1, \text{ yields a remainder equal to:}$$

$$D^9 + D^8 + D^7 + D^6 + D^5 + D^4 + D^3 + D^2 + D + 1.$$

Thus the encoded bits  $\{u(0),u(1),\dots,u(38)\}$  are:

$$u(k) = d(k) \quad \text{for } k = 0,1,\dots,24$$

$$u(k) = p(k-25) \quad \text{for } k = 25,26,\dots,34$$

$$u(k) = 0 \quad \text{for } k = 35,36,37,38 \text{ (tail bits)}$$

The bits  $\{e(0),e(1),\dots,e(77)\}$  are obtained by the convolutional code of rate 1/2, defined by the polynomials:

$$G_0 = 1 + D^3 + D^4$$

$$G_1 = 1 + D + D^3 + D^4$$

and with:

$$e(2k) = u(k) + u(k-3) + u(k-4)$$

$$e(2k+1) = u(k) + u(k-1) + u(k-3) + u(k-4) \quad \text{for } k = 0,1,\dots,77; u(k) = 0 \text{ for } k < 0$$

### 5.1.2.3 Convolutional encoder

This block of 294 bits  $\{u(0),u(1),\dots,u(293)\}$  is encoded with the 1/2 rate convolutional code defined by the polynomials:

$$G_0 = 1 + D^3 + D^4$$

$$G_1 = 1 + D + D^3 + D^4$$

This results in a block of 588 coded bits:  $\{C(0),C(1),\dots,C(587)\}$  defined by:

$$C(2k) = u(k) + u(k-3) + u(k-4)$$

$$C(2k+1) = u(k) + u(k-1) + u(k-3) + u(k-4) \quad \text{for } k = 0,1,\dots,293; u(k) = 0 \text{ for } k < 0$$

The code is punctured in such a way that the following coded bits:

$$\{C(3+4j) \text{ for } j = 3,4,\dots,146 \text{ except for } j = 9,21,33,45,57,69,81,93,105,117,129,141\} \text{ are not transmitted}$$

The result is a block of 456 coded bits,  $\{c(0),c(1),\dots,c(455)\}$ .

### 5.1.3.3 Convolutional encoder

This block of 338 bits  $\{u(0),u(1),\dots,u(337)\}$  is encoded with the 1/2 rate convolutional code defined by the polynomials:

$$G_0 = 1 + D^3 + D^4$$

$$G_1 = 1 + D + D^3 + D^4$$

This results in a block of 676 coded bits:  $\{C(0),C(1),\dots,C(675)\}$  defined by:

$$C(2k) = u(k) + u(k-3) + u(k-4)$$

$$C(2k+1) = u(k) + u(k-1) + u(k-3) + u(k-4) \text{ for } k = 0,1,\dots,337; u(k) = 0 \text{ for } k < 0$$

The code is punctured in such a way that the following coded bits:

$$\{C(3+6j) \text{ and } C(5+6j) \text{ for } j = 2,3,\dots,111\} \text{ are not transmitted}$$

The result is a block of 456 coded bits,  $\{c(0),c(1),\dots,c(455)\}$ .

### 5.3.2 Extended Packet Access Burst

The burst carrying the extended packet random access uplink message contains 11 information bits  $d(0), d(1), \dots, d(10)$ .

Six parity bits  $p(0), p(1), \dots, p(5)$  are defined in such a way that in GF(2) the binary polynomial:

$$d(0)D^{16} + \dots + d(10)D^6 + p(0)D^5 + \dots + p(5), \text{ when divided by } D^6 + D^5 + D^3 + D^2 + D + 1 \text{ yields a remainder equal to } D^5 + D^4 + D^3 + D^2 + D + 1.$$

The six bits of the BSIC,  $\{B(0), B(1), \dots, B(5)\}$ , of the BTS to which the Random Access is intended, are added bitwise modulo 2 to the six parity bits,  $\{p(0), p(1), \dots, p(5)\}$ . This results in six colour bits,  $C(0)$  to  $C(5)$  defined as  $C(k) = b(k) + p(k)$  ( $k = 0$  to  $5$ ) where:

$$b(0) = \text{MSB of PLMN colour code}$$

$$b(5) = \text{LSB of BS colour code.}$$

This defines  $\{u(0), u(1), \dots, u(20)\}$  by:

$$u(k) = d(k) \quad \text{for } k = 0, 1, \dots, 10$$

$$u(k) = C(k-11) \quad \text{for } k = 11, 12, \dots, 16$$

$$u(k) = 0 \quad \text{for } k = 17, 18, 19, 20 \text{ (tail bits)}$$

The coded bits  $\{c(0), c(1), \dots, c(41)\}$  are obtained by the convolutional code of rate 1/2, defined by the polynomials:

$$G_0 = 1 + D^3 + D^4$$

$$G_1 = 1 + D + D^3 + D^4$$

and with:

$$c(2k) = u(k) + u(k-3) + u(k-4)$$

$$c(2k+1) = u(k) + u(k-1) + u(k-3) + u(k-4) \quad \text{for } k = 0, 1, \dots, 20; u(k) = 0 \text{ for } k < 0$$

The code is punctured in such a way that the following coded bits:

$$c(0), c(2), c(5), c(37), c(39), c(41) \text{ are not transmitted.}$$

This results in a block of 36 coded bits,  $\{e(0), e(1), \dots, e(35)\}$ .

## 5.4 Access Burst on packet switched channels other than PRACH and CPRACH

The encoding of this burst is as defined in clause 5.3 for the packet random access channel (PRACH). The BSIC used shall be the BSIC of the BTS to which the burst is intended.

**Table 1: Reordering and partitioning of a coded block of 456 bits into 8 sub-blocks**

$k \bmod 8 =$	0	1	2	3	$k \bmod 8 =$	4	5	6	7
$j=0$	$k=0$	57	114	171	$j=1$	228	285	342	399
2	64	121	178	235	3	292	349	406	7
4	128	185	242	299	5	356	413	14	71
6	192	249	306	363	7	420	21	78	135
8	256	313	370	427	9	28	85	142	199
10	320	377	434	35	11	92	149	206	263
	384	441	42	99		156	213	270	327
	448	49	106	163		220	277	334	391
	56	113	170	227		284	341	398	455
	120	177	234	291		348	405	6	63
20	184	241	298	355	21	412	13	70	127
	248	305	362	419		20	77	134	191
	312	369	426	27		84	141	198	255

k mod 8=	0	1	2	3	k mod 8=	4	5	6	7	
30	376	433	34	91	31	148	205	262	319	
	440	41	98	155		212	269	326	383	
	48	105	162	219		276	333	390	447	
	112	169	226	283		340	397	454	55	
	176	233	290	347		404	5	62	119	
40	240	297	354	411	41	12	69	126	183	
	304	361	418	19		76	133	190	247	
	368	425	26	83		140	197	254	311	
	432	33	90	147		204	261	318	375	
	40	97	154	211		268	325	382	439	
50	104	161	218	275	51	332	389	446	47	
	168	225	282	339		396	453	54	111	
	232	289	346	403		4	61	118	175	
	296	353	410	11		68	125	182	239	
	360	417	18	75		132	189	246	303	
60	424	25	82	139	61	196	253	310	367	
	32	89	146	203		260	317	374	431	
	96	153	210	267		324	381	438	39	
	160	217	274	331		388	445	46	103	
	224	281	338	395		452	53	110	167	
70	288	345	402	3	71	60	117	174	231	
	352	409	10	67		124	181	238	295	
	416	17	74	131		188	245	302	359	
	24	81	138	195		252	309	366	423	
	88	145	202	259		316	373	430	31	
80	152	209	266	323	81	380	437	38	95	
	216	273	330	387		444	45	102	159	
	280	337	394	451		52	109	166	223	
	344	401	2	59		116	173	230	287	
	408	9	66	123		180	237	294	351	
90	16	73	130	187	91	244	301	358	415	
	80	137	194	251		308	365	422	23	
	144	201	258	315		372	429	30	87	
	208	265	322	379		436	37	94	151	
	272	329	386	443		44	101	158	215	
100	336	393	450	51	101	108	165	222	279	
	400	1	58	115		172	229	286	343	
	8	65	122	179		236	293	350	407	
	72	129	186	243		300	357	414	15	
	136	193	250	307		364	421	22	79	
110	200	257	314	371	111	428	29	86	143	
	264	321	378	435		36	93	150	207	
	328	385	442	43		100	157	214	271	
	112	392	449	50		113	164	221	278	335

Table 15: Interleaving table for MCS5 and MCS6

m\l	0	1	2	3	4	5	6	7	8	9	10	11	12	13	14	15
0	0	463	890	1038	220	371	795	946	582	733	1160	63	490	641	277	428
1	852	1003	185	333	1223	120	547	698	1122	28	915	1066	242	390	817	968
2	610	761	1185	85	512	660	305	453	880	1031	204	355	782	1242	148	575
3	723	1150	50	474	625	1088	267	418	845	993	169	320	1207	113	537	688
4	1115	12	902	1050	232	383	807	958	594	745	1172	75	502	653	289	440
5	864	1015	197	345	1235	132	559	710	1134	40	927	1078	254	402	829	980
6	159	622	773	1197	97	524	672	1099	5	465	892	1043	216	367	794	942
7	587	735	1162	62	486	637	279	430	857	1005	181	332	1219	125	549	700
8	1127	24	914	1062	244	395	819	970	606	757	1184	87	514	665	301	452
9	876	1027	209	357	784	1247	144	571	722	1146	52	479	627	1090	266	414
10	841	992	171	322	1209	109	536	684	1111	17	904	1055	228	379	806	954
11	599	747	1174	74	498	649	291	442	869	1017	193	344	1231	137	561	712
12	1139	36	926	1074	256	407	831	982	158	618	769	1196	99	526	677	1101
13	7	458	894	1033	227	363	802	941	577	740	1152	70	485	645	284	420
14	859	998	189	328	1215	127	542	702	1117	35	922	1061	246	385	824	960
15	605	765	1180	92	504	667	309	448	887	1023	211	350	786	1237	155	567
16	730	1145	54	469	632	1080	274	413	849	988	176	312	1202	117	532	695
17	1107	19	906	1045	239	375	814	953	589	752	1164	82	497	657	296	432
18	871	1010	201	340	1227	139	554	714	1129	47	934	1073	258	397	836	972

m\n	0	1	2	3	4	5	6	7	8	9	10	11	12	13	14	15
19	166	617	777	1192	104	516	679	1094	9	460	899	1035	223	362	798	937
20	579	742	1157	66	481	644	286	425	861	1000	188	324	1214	129	544	707
21	1119	31	918	1057	251	387	826	965	601	764	1176	94	509	669	308	444
22	883	1022	213	352	791	1239	151	566	726	1141	59	471	634	1085	270	409
23	848	984	178	317	1204	116	528	691	1106	21	911	1047	235	374	810	949
24	591	754	1169	78	493	656	298	437	873	1012	200	336	1226	141	556	719
25	1131	43	930	1069	263	399	838	977	162	613	776	1188	106	521	681	1096
26	2	462	889	1040	219	370	797	945	584	732	1159	65	489	640	276	427
27	854	1002	184	335	1222	122	546	697	1124	27	917	1065	241	392	816	967
28	609	760	1187	84	511	662	304	455	879	1030	206	354	781	1244	147	574
29	725	1149	49	476	624	1087	269	417	844	995	168	319	1206	112	539	687
30	1114	14	901	1052	231	382	809	957	596	744	1171	77	501	652	288	439
31	866	1014	196	347	1234	134	558	709	1136	39	929	1077	253	404	828	979
32	161	621	772	1199	96	523	674	1098	4	467	891	1042	218	366	793	944
33	586	737	1161	61	488	636	281	429	856	1007	180	331	1218	124	551	699
34	1126	26	913	1064	243	394	821	969	608	756	1183	89	513	664	300	451
35	878	1026	208	359	783	1246	146	570	721	1148	51	478	629	1089	265	416
36	840	991	173	321	1211	108	535	686	1110	16	903	1054	230	378	805	956
37	598	749	1173	73	500	648	293	441	868	1019	192	343	1230	136	563	711
38	1138	38	925	1076	255	406	833	981	157	620	768	1195	101	525	676	1103
39	6	457	896	1032	226	365	801	940	576	739	1154	69	484	647	283	422
40	858	997	191	327	1217	126	541	704	1116	34	921	1060	248	384	823	962
41	604	767	1179	91	506	666	311	447	886	1025	210	349	788	1236	154	569
42	729	1144	56	468	631	1082	273	412	851	987	175	314	1201	119	531	694
43	1109	18	908	1044	238	377	813	952	588	751	1166	81	496	659	295	434
44	870	1009	203	339	1229	138	553	716	1128	46	933	1072	260	396	835	974
45	165	616	779	1191	103	518	678	1093	11	459	898	1037	222	361	800	936
46	581	741	1156	68	480	643	285	424	863	999	187	326	1213	131	543	706
47	1121	30	920	1056	250	389	825	964	600	763	1178	93	508	671	307	446
48	882	1021	215	351	790	1241	150	565	728	1140	58	473	633	1084	272	408
49	847	986	177	316	1203	115	530	690	1105	23	910	1049	234	373	812	948
50	593	753	1168	80	492	655	297	436	875	1011	199	338	1225	143	555	718
51	1133	42	932	1068	262	401	837	976	164	612	775	1190	105	520	683	1095
52	1	464	888	1039	221	369	796	947	583	734	1158	64	491	639	278	426
53	853	1004	183	334	1221	121	548	696	1123	29	916	1067	240	391	818	966
54	611	759	1186	86	510	661	303	454	881	1029	205	356	780	1243	149	573
55	724	1151	48	475	626	1086	268	419	843	994	170	318	1208	111	538	689
56	1113	13	900	1051	233	381	808	959	595	746	1170	76	503	651	290	438
57	865	1016	195	346	1233	133	560	708	1135	41	928	1079	252	403	830	978
58	160	623	771	1198	98	522	673	1100	3	466	893	1041	217	368	792	943
59	585	736	1163	60	487	638	280	431	855	1006	182	330	1220	123	550	701
60	1125	25	912	1063	245	393	820	971	607	758	1182	88	515	663	302	450
61	877	1028	207	358	785	1245	145	572	720	1147	53	477	628	1091	264	415
62	842	990	172	323	1210	110	534	685	1112	15	905	1053	229	380	804	955
63	597	748	1175	72	499	650	292	443	867	1018	194	342	1232	135	562	713
64	1137	37	924	1075	257	405	832	983	156	619	770	1194	100	527	675	1102
65	8	456	895	1034	225	364	803	939	578	738	1153	71	483	646	282	421
66	860	996	190	329	1216	128	540	703	1118	33	923	1059	247	386	822	961
67	603	766	1181	90	505	668	310	449	885	1024	212	348	787	1238	153	568
68	731	1143	55	470	630	1081	275	411	850	989	174	313	1200	118	533	693
69	1108	20	907	1046	237	376	815	951	590	750	1165	83	495	658	294	433
70	872	1008	202	341	1228	140	552	715	1130	45	935	1071	259	398	834	973
71	167	615	778	1193	102	517	680	1092	10	461	897	1036	224	360	799	938
72	580	743	1155	67	482	642	287	423	862	1001	186	325	1212	130	545	705
73	1120	32	919	1058	249	388	827	963	602	762	1177	95	507	670	306	445
74	884	1020	214	353	789	1240	152	564	727	1142	57	472	635	1083	271	410
75	846	985	179	315	1205	114	529	692	1104	22	909	1048	236	372	811	950
76	592	755	1167	79	494	654	299	435	874	1013	198	337	1224	142	557	717
77	1132	44	931	1070	261	400	839	975	163	614	774	1189	107	519	682	1097

This table describes the interleaving applied to MCS-5 and MCS-6

$$di(j') = dc(k') \text{ for } k' = 0,1,\dots,1\ 223$$

$$k' = 16*m + n$$

The value of j' for a given k is in the cell located in the row m and in the column n.

---

## Annex A to GSM 05.03 (informative): Summary of Channel Types

SACCH	slow associated control channel
FACCH/F	fast associated control channel at full rate
FACCH/H	fast associated control channel at half rate
SDCCH	stand-alone dedicated control channel
BCCH	broadcast control channel
PCH	paging channel
AGCH	access grant channel
RACH	random access channel
SCH	synchronization channel
CBCH	cell broadcast channel
PDTCH	packet data traffic channel
PACCH	packet associated control channel
PBCCH	packet broadcast control channel
PAGCH	packet access grant channel
PPCH	packet paging channel
PNCH	packet notification channel
PTCCH	packet timing advance control channel
PRACH	packet random access channel
CFCH	Compact Frequency Correction Channel
CPAGCH	Compact Packet Access Grant Channel
CPBCCH	Compact Packet Broadcast Control Channel
CPCCCH	Compact Packet Common Control Channel
CPNCH	Compact Packet Notification Channel (for PTM-M on CPCCCH)
CPPCH	Compact Packet Paging Channel
CPRACH	Compact Packet Random Access Channel
CSCH	Compact Synchronization Channel



---

## Annex B to GSM 05.03 (informative): Summary of Polynomials Used for Convolutional Codes

$G_0 = 1 + D^3 + D^4$	SDCCH, BCCH, PCH, SACCH, FACCH, E-FACCH, AGCH, RACH, SCH, CSCH, PDTCH (CS-1, CS-2, CS-3, CS-4), PACCH, PBCCH, PAGCH, PPCH, PNCH, PTCCH, PRACH, CPBCCH, CPAGCH, CPPCH, CPNCH
$G_1 = 1 + D + D^3 + D^4$	SACCH, FACCH, E-FACCH, SDCCH, BCCH, PCH, AGCH, RACH, SCH, PDTCH (CS-1, CS-2, CS-3, CS-4), PACCH, PBCCH, PAGCH, PPCH, PNCH, PTCCH, PRACH, CPBCCH, CPAGCH, CPPCH, CPNCH, CPNCH
$G_4 = 1 + D^2 + D^3 + D^5 + D^6$	PDTCH (MCS-1, MCS-2, MCS-3, MCS-4, MCS-5, MCS-6, MCS-7, MCS-8, MCS-9)
$G_5 = 1 + D + D^4 + D^6$	PDTCH (MCS-1, MCS-2, MCS-3, MCS-4, MCS-5, MCS-6, MCS-7, MCS-8, MCS-9)
$G_7 = 1 + D + D^2 + D^3 + D^6$	PDTCH (MCS-1, MCS-2, MCS-3, MCS-4, MCS-5, MCS-6, MCS-7, MCS-8, MCS-9)

---

## Annex F (normative): Modification to GSM 05.05

This annex details the modified clauses of GSM 05.05 which are applicable to TAPS.

All references to other GSM standards and specifications are to the standards as modified by the present document.

Where the following channel names appear in diagrams, they should be treated as if they had been deleted.

- CTSARCH
- CTSAGCH
- CTSBCH
- CTSPCH
- TCH/EF
- TCH/AFS
- TCH/AHS
- TCH/HS
- TCH/EFS
- TCH/AF
- TCH/AH
- TCH/FS
- E-TCH/F followed by a data rate
- TCH/F followed by a data rate
- TCH/H followed by a data rate
- HSCSD
- ECSD
- NCH

The following clauses have the same numbering as in GSM 05.05.

---

## 2 Frequency bands and channel arrangement

- i) GSM 450 Band:
  - for GSM 450, the system is required to operate in the following band:
    - 450,4 MHz to 457,6 MHz: mobile transmit, base receive;
    - 460,4 MHz to 467,6 MHz base transmit, mobile receive.
- ii) GSM 480 Band;
  - for GSM 480, the system is required to operate in the following band:
    - 478,8 MHz to 486 MHz: mobile transmit, base receive;

- 488,8 MHz to 496 MHz base transmit, mobile receive.

iii) GSM 850 Band:

- for GSM 850, the system is required to operate in the following band:
  - 824 MHz to 849 MHz: mobile transmit, base receive;
  - 869 MHz to 894 MHz: base transmit, mobile receive.

iv) Standard or primary GSM 900 Band, P-GSM:

- for Standard GSM 900 band, the system is required to operate in the following frequency band:
  - 890 MHz to 915 MHz: mobile transmit, base receive;
  - 935 MHz to 960 MHz: base transmit, mobile receive.

v) Extended GSM 900 Band, E-GSM (includes Standard GSM 900 band):

- for Extended GSM 900 band, the system is required to operate in the following frequency band:
  - 880 MHz to 915 MHz: mobile transmit, base receive;
  - 925 MHz to 960 MHz: base transmit, mobile receive.

vi) Railways GSM 900 Band, R-GSM (includes Standard and Extended GSM 900 Band);

- for Railways GSM 900 band, the system is required to operate in the following frequency band:
  - 876 MHz to 915 MHz: mobile transmit, base receive;
  - 921 MHz to 960 MHz: base transmit, mobile receive.

vii) DCS 1800 Band:

- for DCS 1800, the system is required to operate in the following band:
  - 1 710 MHz to 1 785 MHz: mobile transmit, base receive;
  - 1 805 MHz to 1 880 MHz: base transmit, mobile receive.

viii) PCS 1900 Band:

- for PCS 1900, the system is required to operate in the following band:
  - 1 850 MHz to 1 910 MHz: mobile transmit, base receive;
  - 1 930 MHz to 1 990 MHz base transmit, mobile receive.

ix) TETRA 380 Band:

- for TETRA 380, the system is required to operate in the following band:
  - 380 MHz to 390 MHz: mobile transmit, base receive;
  - 390 MHz to 400 MHz base transmit, mobile receive.

x) TETRA 410 Band:

- for TETRA 410, the system is required to operate in the following band:
  - 410 MHz to 420 MHz: mobile transmit, base receive;
  - 420 MHz to 430 MHz base transmit, mobile receive.

xi) TETRA 450 Band:

- for TETRA 450, the system is required to operate in the following band:
- 450 MHz to 460 MHz: mobile transmit, base receive;
- 460 MHz to 470 MHz base transmit, mobile receive.

xii) TETRA 870 Band:

- for TETRA 870, the system is required to operate in the following band:
- 870 MHz to 876 MHz: mobile transmit, base receive;
- 915 MHz to 921 MHz base transmit, mobile receive.

NOTE 1: The term GSM 400 is used for any GSM system, which operates in any 400 MHz band. The TETRA system in the 400 MHz range (380-400 MHz, 410-430 MHz and 450-470 MHz) is covered by the term GSM 400 unless explicitly mentioned in the appropriate clause(s).

NOTE 2: The term GSM 850 is used for any GSM system which operates in the GSM 850 MHz.

NOTE 3: The term GSM 900 is used for any GSM or TETRA system, which operates in any 900 MHz band. The TETRA system in the 870-876 MHz/915-921 MHz band is covered by the term GSM 900 unless explicitly mentioned in the appropriate clause(s).

NOTE 4: The BTS may cover a complete band, or the BTS capabilities may be restricted to a subset only, depending on the operator needs.

Operators may implement networks which operates on a combination of the frequency bands above to support multi band mobile terminals which are defined in 3GPP TS 02.06.

The carrier spacing is 200 kHz.

The carrier frequency is designated by the absolute radio frequency channel number (ARFCN). If we call  $F_l(n)$  the frequency value of the carrier ARFCN  $n$  in the lower band, and  $F_u(n)$  the corresponding frequency value in the upper band, we have:

P-GSM 900	$F_l(n) = 890 + 0,2*n$	$1 \leq n \leq 124$	$F_u(n) = F_l(n) + 45$
E-GSM 900	$F_l(n) = 890 + 0,2*n$ $F_l(n) = 890 + 0,2*(n-1 024)$	$0 \leq n \leq 124$ $975 \leq n \leq 1 023$	$F_u(n) = F_l(n) + 45$
R-GSM 900	$F_l(n) = 890 + 0,2*n$ $F_l(n) = 890 + 0,2*(n-1 024)$	$0 \leq n \leq 124$ $955 \leq n \leq 1 023$	$F_u(n) = F_l(n) + 45$
DCS 1800	$F_l(n) = 1 710,2 + 0,2*(n-512)$	$512 \leq n \leq 885$	$F_u(n) = F_l(n) + 95$
PCS 1900	$F_l(n) = 1 850,2 + 0,2*(n-512)$	$512 \leq n \leq 810$	$F_u(n) = F_l(n) + 80$
GSM 450	$F_l(n) = 450,6 + 0,2*(n-259)$	$259 \leq n \leq 293$	$F_u(n) = F_l(n) + 10$
GSM 480	$F_l(n) = 479 + 0,2*(n-306)$	$306 \leq n \leq 340$	$F_u(n) = F_l(n) + 10$
GSM 850	$F_l(n) = 824,2 + 0,2*(n-128)$	$128 \leq n \leq 251$	$F_u(n) = F_l(n) + 45$
TETRA 380	$F_l(n) = 380,2 + 0,2*(n-356)$	$356 \leq n \leq 404$	$F_u(n) = F_l(n) + 10$
TETRA 410	$F_l(n) = 410,2 + 0,2*(n-406)$	$406 \leq n \leq 464$	$F_u(n) = F_l(n) + 10$
TETRA 450	$F_l(n) = 450,6 + 0,2*(n-259)$	$257 \leq n \leq 305$	$F_u(n) = F_l(n) + 10$
TETRA 870	$F_l(n) = 890 + 0,2*(n-1 024)$	$925 \leq n \leq 954$	$F_u(n) = F_l(n) + 45$

Frequencies are in MHz.

### 4.1.1 Mobile Station

The MS maximum output power and lowest power control level shall be, according to its class, as defined in the following tables (see also 3GPP TS 02.06).

For GMSK modulation

Power class	GSM 400 and GSM 900 and GSM 850 Nominal Maximum output Power	DCS 1800 Nominal Maximum output power	PCS 1900 Nominal Maximum output power	Tolerance (dB) for conditions	
				normal	extreme
1	-----	1 W (30 dBm)	1 W (30 dBm)	±2	±2,5
2	8 W (39 dBm)	0,25 W (24 dBm)	0,25 W (24 dBm)	±2	±2,5
3	5 W (37 dBm)	4 W (36 dBm)	2 W (33 dBm)	±2	±2,5
4	2 W (33 dBm)			±2	±2,5
5	0,8 W (29 dBm)			±2	±2,5

For 8-PSK modulation

Power class	GSM 400 and GSM 900 and GSM 850 Nominal Maximum output Power	GSM 400 and GSM 900 and GSM 850 Tolerance (dB) for conditions		DCS 1800 Nominal Maximum output power	PCS 1900 Nominal Maximum output power	DCS 1800 and PCS 1900 Tolerance (dB) for conditions	
		normal	extreme			normal	extreme
E1	33 dBm	±2	±2,5	30 dBm	30 dBm	±2	±2,5
E2	27 dBm	±3	±4	26 dBm	26 dBm	-4/+3	-4,5/+4
E3	23 dBm	±3	±4	22 dBm	22 dBm	±3	±4

Maximum output power for 8-PSK in any one band is always equal to or less than GMSK maximum output power for the same equipment in the same band.

A multi band MS has a combination of the power class in each band of operation from the table above. Any combination may be used.

The PCS 1900, including its actual antenna gain, shall not exceed a maximum of 2 Watts (+33 dBm) EIRP per the applicable FCC rules for wideband PCS services [FCC Part 24, Subpart E, Section 24.232]. Power Class 3 is restricted to transportable or vehicular mounted units.

For GSM 850 MS, including its actual antenna gain, shall not exceed a maximum of 7 Watts (+38,5 dBm) ERP per the applicable FCC rules for public mobile services. [FCC Part 22, Subpart H, Section 22.913]

The different power control levels needed for adaptive power control (see 3GPP TS 05.08) shall have the nominal output power as defined in the table below, starting from the power control level for the lowest nominal output power up to the power control level for the maximum nominal output power corresponding to the class of the particular MS as defined in the table above. Whenever a power control level commands the MS to use a nominal output power equal to or greater than the maximum nominal output power for the power class of the MS, the nominal output power transmitted shall be the maximum nominal output power for the MS class, and the tolerance specified for that class (see table above) shall apply.

## GSM 400 and GSM 900 and GSM 850

Power control level	Nominal Output power (dBm)	Tolerance (dB) for conditions	
		normal	extreme
0-2	39	±2	±2,5
3	37	±3	±4
4	35	±3	±4
5	33	±3	±4
6	31	±3	±4
7	29	±3	±4
8	27	±3	±4
9	25	±3	±4
10	23	±3	±4
11	21	±3	±4
12	19	±3	±4
13	17	±3	±4
14	15	±3	±4
15	13	±3	±4
16	11	±5	±6
17	9	±5	±6
18	7	±5	±6
19-31	5	±5	±6

## DCS 1800

Power control level	Nominal Output power (dBm)	Tolerance (dB) for conditions	
		normal	extreme
29	36	±2	±2,5
30	34	±3	±4
31	32	±3	±4
0	30	±3	±4
1	28	±3	±4
2	26	±3	±4
3	24	±3	±4
4	22	±3	±4
5	20	±3	±4
6	18	±3	±4
7	16	±3	±4
8	14	±3	±4
9	12	±4	±5
10	10	±4	±5
11	8	±4	±5
12	6	±4	±5
13	4	±4	±5
14	2	±5	±6
15-28	0	±5	±6

NOTE 1: For DCS 1800, the power control levels 29, 30 and 31 are not used when transmitting the parameter `MS_TXPWR_MAX_CCH` on BCCH, for cross phase compatibility reasons. If levels greater than 30 dBm are required from the MS during a random access attempt, then these shall be decoded from parameters broadcast on the BCCH as described in 3GPP TS 05.08.

Furthermore, the difference in output power actually transmitted by the MS between two power control levels where the difference in nominal output power indicates an increase of 2 dB (taking into account the restrictions due to power class), shall be  $+2 \pm 1,5$  dB. Similarly, if the difference in output power actually transmitted by the MS between two power control levels where the difference in nominal output power indicates a decrease of 2 dB (taking into account the restrictions due to power class), shall be  $-2 \pm 1,5$  dB.

NOTE 2: A 2 dB nominal difference in output power can exist for non-adjacent power control levels e.g. power control levels 18 and 22 for GSM 400 and GSM 900; power control levels 31 and 0 for class 3 DCS 1800 and power control levels 3 and 6 for class 4 GSM 400 and GSM 900.

A change from any power control level to any power control level may be required by the base transmitter. The maximum time to execute this change is specified in 3GPP TS 05.08.

### PCS 1900

Power Control Level	Output Power (dBm)	Tolerance (dB) for conditions	
		Normal	Extreme
22-29	Reserved	Reserved	Reserved
30	33	±2 dB	±2,5 dB
31	32	±2 dB	±2,5 dB
0	30	±3 dB <sup>1</sup>	±4 dB <sup>1</sup>
1	28	±3 dB	±4 dB
2	26	±3 dB	±4 dB
3	24	±3 dB <sup>1</sup>	±4 dB <sup>1</sup>
4	22	±3 dB	±4 dB
5	20	±3 dB	±4 dB
6	18	±3 dB	±4 dB
7	16	±3 dB	±4 dB
8	14	±3 dB	±4 dB
9	12	±4 dB	±5 dB
10	10	±4 dB	±5 dB
11	8	±4 dB	±5 dB
12	6	±4 dB	±5 dB
13	4	±4 dB	±5 dB
14	2	±5 dB	±6 dB
15	0	±5 dB	±6 dB
16-21	Reserved	Reserved	Reserved

NOTE: Tolerance for MS Power Classes 1 and 2 is ±2 dB normal and ±2,5 dB extreme at Power Control Levels 0 and 3 respectively.

The output power actually transmitted by the MS at each of the power control levels shall form a monotonic sequence, and the interval between power steps shall be 2 dB ± 1,5 dB except for the step between power control levels 30 and 31 where the interval is 1 dB ± 1 dB.

The MS transmitter may be commanded by the BTS to change from any power control level to any other power control level. The maximum time to execute this change is specified in 3GPP TS 05.08.

#### 4.3.2.1 General requirements

The power measured in the conditions specified in clause 4.3.1a shall be no more than -36 dBm.

The power measured in the conditions specified in clause 4.3.1b be no more than:

- 250 nW (-36 dBm) in the frequency band 9 kHz to 1 GHz;
- 1 µW (-30 dBm) in the frequency band 1 GHz to 12,75 GHz.

NOTE 1: For radiated spurious emissions for BTS, the specifications currently only apply to the frequency band 30 MHz to 4 GHz. The specification and method of measurement outside this band are under consideration.

In the BTS receive band, the power measured using the conditions specified in clause 4.2.1, with a filter and video bandwidth of 100 kHz shall be no more than.

	<b>GSM 900 and GSM 850 and MXM 850 (dBm)</b>	<b>DCS 1800 and PCS 1900 and MXM 1900 (dBm)</b>
Normal BTS	-98	-98
Micro BTS M1	-91	-96
Micro BTS M2	-86	-91
Micro BTS M3	-81	-86
Pico BTS P1	-70	-80
R-GSM 900 BTS	-89	

These values assume a 30 dB coupling loss between transmitter and receiver. If BTSs of different classes are co-sited, the coupling loss must be increased by the difference between the corresponding values from the table above.

Measures must be taken for mutual protection of receivers when BTS of different bands are co-sited.

NOTE 2: Thus, for this case, assuming the coupling losses are as above, then the power measured in the conditions specified in clause 4.2.1, with a filter and video bandwidth of 100 kHz should be no more than the values in the table above for the GSM 400 and GSM 900 transmitter in the band 1 710 MHz to 1 785 MHz, for GSM 400 and DCS 1800 transmitter in the band 870 MHz to 915 MHz and for GSM 900 and DCS 1800 transmitter in the bands 380 to 390 MHz, 410 to 420 MHz, 450 to 460 MHz and 478,8 MHz to 486,0 MHz.

In any case, the powers measured in the conditions specified in clause 4.2.1, with a filter and video bandwidth of 100 kHz shall be no more than -47 dBm for the GSM 400 and GSM 900 BTS in the band 1 805 MHz to 1 880 MHz and -57 dBm for a GSM 400 and DCS 1800 BTS in the band 915 MHz to 960 MHz.

Measures must be taken for mutual protection of receivers when MXM 850 and MXM 1900 BTS, or GSM 850 and PCS 1900 BTS are co-sited.

NOTE 3: Thus, for this case, assuming the coupling losses are as above, then the power measured in the conditions specified in clause 4.2.1, with a filter and video bandwidth of 100 kHz should be no more than the values in the table above for the MXM 850 (or GSM 850 BTS) transmitter in the band 1 850 MHz to 1 910 MHz and for MXM 1900 (or PCS 1900 BTS) transmitter in the band 824 MHz to 849 MHz.

In any case, the powers measured in the conditions specified in clause 4.2.1, with a filter and video bandwidth of 100 kHz shall be no more than -47 dBm for an MXM 850 BTS (or GSM 850 BTS) in the band 1 930 MHz to 1 990 MHz and -57 dBm for an MXM 1900 BTS (or PCS 1900 BTS) in the band 869 MHz to 894 MHz.

NOTE 4: In addition, to protect co-coverage systems, the powers measured in the conditions specified in clause 4.2.1, with a filter and video bandwidth of 100 kHz should be no more than -57 dBm for the GSM 900 and DCS 1800 BTS in the bands 390 to 400 MHz, 420 to 430 MHz, and 460 MHz to 470 MHz and 488,8 MHz to 496,0 MHz.

#### 4.3.3.1 Mobile Station GSM 400, GSM 900 and DCS 1800

The power measured in the conditions specified in clause 4.3.1a, for a MS when allocated a channel, shall be no more than -36 dBm.

The power measured in the conditions specified in clause 4.3.1b for a MS, when allocated a channel, shall be no more than (see also note in clause 4.3.1b above):

- 250 nW (-36 dBm) in the frequency band 9 kHz to 1 GHz;
- 1  $\mu$ W (-30 dBm) in the frequency band 1 GHz to 12,75 GHz.

The power measured in a 100 kHz bandwidth for a MS, when not allocated a channel (idle mode), shall be no more than (see also note in clause 4.3.1 above):

- 2 nW (-57 dBm) in the frequency bands 9 kHz to 1 000 MHz;
- 20 nW (-47 dBm) in the frequency bands 1 GHz to 12,75 GHz,

with the following exceptions:

- 1,25 nW (-59 dBm) in the frequency band 870 MHz to 915 MHz;



- 5 nW (-53 dBm) in the frequency band 1,71 GHz to 1,785 GHz;
- -76 dBm in the frequency bands 1 900 MHz to 1 920 MHz, 1 920 MHz to 1 980 MHz, 2 010 MHz to 2 025 MHz, and 2 210 MHz to 2 170 MHz.

NOTE: The idle mode spurious emissions in the receive band are covered by the case for MS allocated a channel (see below).

When allocated a channel, the power emitted by the MS, when measured using the measurement conditions specified in clause 4.2.1, but with averaging over at least 50 burst measurements, with a filter and video bandwidth of 100 kHz, for measurements centred on 200 kHz multiples shall be no more than:

- -62 dBm in the bands 390 MHz to 400 MHz and 420 MHz to 430 MHz and 460 MHz to 470 MHz  
for TETRA 380, TETRA 410 and TETRA 450 MS only;
- -67 dBm in the bands 460,4 MHz to 467,6 MHz and 488,8 MHz to 496 MHz for GSM 400 (excluding TETRA) MS only;
- -67 dBm in the band 915 MHz to 921 MHz for TETRA 870 MS only;
- -60 dBm in the band 921 MHz to 925 MHz for R-GSM MS only;
- -67 dBm in the band 925 MHz to 935 MHz;
- -79 dBm in the band 935 MHz to 960 MHz;
- -71 dBm in the band 1 805 MHz to 1 880 MHz;
- -66 dBm in the bands 1 900 MHz to 1 920 MHz, 1 920 MHz to 1 980 MHz, 2 010 MHz to 2 025 MHz, and 2 110 MHz to 2 170 MHz.

As exceptions up to five measurements with a level up to -36 dBm are permitted in each of the bands 925 MHz to 960 MHz, 1 805 MHz to 1 880 MHz, 1 900 MHz to 1 920 MHz, 1 920 MHz to 1 980 MHz, 2 010 MHz to 2 025 MHz, and 2 110 MHz to 2 170 MHz for each ARFCN used in the measurements. For GSM 400 MS, in addition, exceptions up to three measurements with a level up to -36 dBm are permitted in each of the bands 460,4 MHz to 467,6 MHz and 488,8 MHz to 496 MHz for each ARFCN used in the measurements.

When hopping, this applies to each set of measurements, grouped by the hopping frequencies as described in clause 4.2.1.

#### 4.5.1 Base Transceiver Station

The BTS shall be capable of not transmitting a burst in a time slot not used by a logical channel. The output power relative to time when sending a burst is shown in annex B. The reference level 0 dB corresponds to the output power level according to clause 4. In the case where the bursts in two (or several) consecutive time slots are actually transmitted, at the same frequency, the template of annex B shall be respected during the useful part of each burst and at the beginning and the end of the series of consecutive bursts. The output power during the guard period between every two consecutive active timeslots shall not exceed the level allowed for the useful part of the first timeslot, or the level allowed for the useful part of the second timeslot plus 3 dB, whichever is the highest. The residual output power, if a timeslot is not activated, shall be maintained at, or below, a level of -30 dBc on the frequency channel in use. All emissions related to other frequency channels shall be in accordance with the wide band noise and spurious emissions requirements.

A measurement bandwidth of at least 300 kHz is assumed.

## 5 Receiver characteristics

In this clause, the requirements are given in terms of power levels at the antenna connector of the receiver. Equipment with integral antenna may be taken into account by converting these power level requirements into field strength requirements, assuming a 0 dBi gain antenna. This means that the tests on equipment on integral antenna will consider fields strengths (E) related to the power levels (P) specified, by the following formula (derived from the formula  $E = P + 20\log F_{(\text{MHz})} + 77,2$ ):

assuming  $F = 405 \text{ MHz}$  :  $E \text{ (dB}\mu\text{V/m)} = P \text{ (dBm)} + 129,3$  for TETRA 380, TETRA 410, TETRA 450;

assuming  $F = 460 \text{ MHz}$  :  $E \text{ (dB}\mu\text{V/m)} = P \text{ (dBm)} + 130,5$  for GSM 450 and GSM 480;

assuming  $F = 859 \text{ MHz}$  :  $E \text{ (dB}\mu\text{V/m)} = P \text{ (dBm)} + 135,9$  for GSM 850;

assuming  $F = 925 \text{ MHz}$  :  $E \text{ (dB}\mu\text{V/m)} = P \text{ (dBm)} + 136,5$  for GSM 900;

assuming  $F = 1\,795 \text{ MHz}$  :  $E \text{ (dB}\mu\text{V/m)} = P \text{ (dBm)} + 142,3$  for DCS 1800;

assuming  $F = 1\,920 \text{ MHz}$  :  $E \text{ (dB}\mu\text{V/m)} = P \text{ (dBm)} + 142,9$  for PCS 1900.

Static propagation conditions are assumed in all cases, for both wanted and unwanted signals. For clauses 5.1 and 5.2, values given in dBm are indicative, and calculated assuming a  $50 \Omega$  impedance.

### 5.1 Blocking characteristics

The blocking characteristics of the receiver are specified separately for in-band and out-of-band performance as identified in the following tables.

Frequency Band	Frequency range (MHz)			
	GSM 900 (excl TETRA 870) MS	TETRA 870 BTS	E-GSM 900 BTS	R-GSM 900 BTS
in-band	915 to 980	870 to 925	860 to 925	856 to 921
out-of-band (a)	0,1 to < 912	0,1 to < 850	0,1 to < 860	0,1 to < 856
out-of-band (b)	N/A	N/A	N/A	N/A
out-of band (c)	N/A	N/A	N/A	N/A
out-of band (d)	> 980 to 12,750	> 915 to 12,750	> 925 to 12,750	> 921 to 12,750

Frequency band	Frequency range (MHz) TETRA 870	
	MS	BTS
in-band	912 to 980	850 to 915
out-of-band (a)	0,1 to < 912	0,1 to < 850
out-of-band (b)	N/A	N/A
out-of band (c)	N/A	N/A
out-of band (d)	> 980 to 12,750	> 915 to 12,750

Frequency band	Frequency range (MHz) DCS 1800	
	MS	BTS
in-band	1 785 to 1 920	1 690 to 1 805
out-of-band (a)	0,1 to 1705	0,1 to < 1 690
out-of-band (b)	> 1 705 to < 1 785	N/A
out-of band (c)	> 1 920 to 1 980	N/A
out-of band (d)	> 1 980 to 12,750	> 1 805 to 12,750

Frequency band	Frequency range (MHz)	
	PCS 1900 MS	PCS 1900 and MXM 1900 BTS
in-band	1 910 to 2 010	1 830 to 1 930
out-of-band (a)	0,1 to < 1 830	0,1 to < 1 830
out-of-band (b)	1 830 to < 1 910	N/A
out-of band (c)	> 2 010 to 2 070	N/A
out-of band (d)	> 2 070 to 12,750	> 1 930 to 12,750

Frequency band	Frequency range (MHz)	
	GSM 850 MS	GSM 850 and MXM 850 BTS
in-band	849 to 914	804 to 859
out-of-band (a)	0,1 to < 849	0,1 to < 804
out-of-band (b)	N/A	N/A
out-of band (c)	N/A	N/A
out-of band (d)	> 914 to 12,750	> 859 to 12,750

For the following table:

- ML= Lowest Mobile Tx frequency
- MU=Highest Mobile Tx frequency
- BL= Lowest Base Tx frequency
- BU=Highest Base Tx frequency

authorized in the area of intended operation and BL is at least 2MHz higher than MU giving at least a 2 MHz duplex separation.

Frequency band	Frequency range (MHz)	
	TETRA 380, TETRA 410, TETRA 450 MS	TETRA 380, TETRA 410, TETRA 450 BTS
in-band	(BL-2) - (BU+6)	(ML-6) - (MU+2)
out-of-band (a)	0,1 - < (BL-2)	0,1 - < (ML-6)
out-of-band (b)	N/A	N/A
out-of band (c)	N/A	N/A
out-of band (d)	> (BU+6) to 12,750	> (MU+2) to 12,750

NOTE: Although the TETRA 380, TETRA 410 and TETRA 450 bands are 10 MHz wide, because a duplex separation of at least 2 MHz is needed, administrations are expected to allocate up to only 8 MHz within the 10 MHz band. The allocated frequencies may be selected from any part of the band consistent with this duplex separation, and administrations may choose to allocate frequencies right up to one edge of the band leaving the guard band outside the TETRA band.

Frequency band	Frequency range (MHz)			
	GSM 450		GSM 480	
	MS	BTS	MS	BTS
in-band	457,6 to 473,6	444,4 to 460,4	486,0 to 502,0	472,8 to 488,8
out-of-band (a)	0,1 to < 457,6	0,1 to < 444,4	0,1 to < 486,0	0,1 to- < 472,8
out-of-band (b)	N/A	N/A	N/A	N/A
out-of band (c)	N/A	N/A	N/A	N/A
out-of band (d)	> 473,6 to 12,750	> 460,4 to 12,750	> 502,0 to 12,750	> 488,8 to 12,750

The reference sensitivity performance as specified in tables 1, 1a, 1b, 1c, 1d and 1e shall be met when the following signals are simultaneously input to the receiver:

- for all cases except GSM 850 normal BTS, MXM 850 normal BTS and MXM 1900 normal BTS, a useful signal, modulated with the relevant supported modulation (GMSK or 8-PSK), at frequency  $f_o$ , 3 dB above the reference sensitivity level or input level for reference performance, whichever applicable, as specified in clause 6.2;

- for GSM 850 normal BTS, MXM 850 normal BTS and MXM 1900 normal BTS a useful signal, modulated with the relevant supported modulation (GMSK or 8-PSK), at frequency  $f_0$ , 1 dB above the reference sensitivity level or input level for reference performance, whichever applicable, as specified in clause 6.2;
- a continuous, static sine wave signal at a level as in the table below and at a frequency (f) which is an integer multiple of 200 kHz. For GSM 850 normal BTS, MXM 850 normal BTS and MXM 1900 normal BTS at frequency offsets  $\geq 3\ 000$  kHz this signal is GMSK modulated by any 148-bit sequence of the 511-bit pseudo random bit sequence, defined in ITU-T Recommendation O.153 fascicle IV.4,

with the following exceptions, called spurious response frequencies:

- a) GSM 900 MS and BTS, GSM 850 MS and BTS, and MXM 850 BTS: in band, for a maximum of six occurrences (which if grouped shall not exceed three contiguous occurrences per group);  
  
DCS 1800, PCS 1900 MS and BTS and MXM 1900 BTS: in band, for a maximum of twelve occurrences (which if grouped shall not exceed three contiguous occurrences per group);  
  
GSM 400 MS and BTS: in band, for a maximum of three occurrences;
- b) out of band, for a maximum of 24 occurrences (which if below  $f_0$  and grouped shall not exceed three contiguous occurrences per group).

where the above performance shall be met when the continuous sine wave signal (f) is set to a level of 70 dB $\mu$ V (emf) (i.e. -43 dBm).

NOTE: For testing reasons, a MXM 1900 normal BTS fulfilling the PCS 1900 normal BTS requirements in this paragraph may be considered fulfilling the requirements for MXM 1900 normal BTS.

Frequency band	GSM 400, P-, E- and R-GSM 900						DCS 1800 and PCS 1900			
	other MS		small MS (see note 2)		BTS		MS		BTS	
	dB $\mu$ V (emf)	dBm	dB $\mu$ V (emf)	dBm	dB $\mu$ V (emf)	dBm	dB $\mu$ V (emf)	dBm	dB $\mu$ V (emf)	dBm
in-band										
600 kHz $\leq  f-f_0  < 800$ kHz	75	-38	70	-43	87	-26	70	-43	78	-35
800 kHz $\leq  f-f_0  < 1,6$ MHz	80	-33	70	-43	97	-16	70	-43	88	-25
1,6 MHz $\leq  f-f_0  < 3$ MHz	90	-23	80	-33	97	-16	80	-33	88	-25
3 MHz $\leq  f-f_0 $	90	-23	90	-23	100	-13	87	-26	88	-25
out-of-band										
(a)	113	0	113	0	121	8	113	0	113	0
(b)	-	-	-	-	-	-	101	-12	-	-
(c)	-	-	-	-	-	-	101	-12	-	-
(d)	113	0	113	0	121	8	113	0	113	0

NOTE 1: For definition of small MS, see clause 1.1.  
NOTE 2: These figures do not apply to TETRA 380, TETRA 410 and TETRA 450 for which figures are given in the following table.

The following table gives the figures for the small MS for the TETRA 380 TETRA 410 and TETRA 450 bands:

Frequency band	TETRA 380, TETRA 410 and TETRA 450 small MS	
	dB $\mu$ V (emf)	dBm
in-band		
600 kHz $\leq  f-f_0  < 800$ kHz	70	-43
800 kHz $\leq  f-f_0  < 1,6$ MHz	70	-43
1,6 MHz $\leq  f-f_0  < 3$ MHz	80	-33
3 MHz $\leq  f-f_0 $	90	-23
out-of-band		
(a)	90	-23
(b)	-	-
(c)	-	-
(d)	90	-23

The following exceptions to the level of the sine wave signal (f) in the above table shall apply:

for E-GSM MS, in the band 905 MHz to 915 MHz	-5 dBm
for R-GSM 900 MS, in the band 880 MHz to 915 MHz	-5 dBm
for R-GSM 900 small MS, in the band 876 MHz to 915 MHz	-7 dBm
for GSM 450 small MS, in the band 450,4 MHz to 457,6 MHz	-5 dBm
for GSM 480 small MS, in the band 478,8 MHz to 486 MHz	-5 dBm
for GSM 900 and E-GSM 900 BTS, in the band 915 MHz to 935 MHz	0 dBm
for R-GSM 900 BTS at offsets 600 kHz $\leq \text{abs}(f-f_0) < 3$ MHz, in the band 876 MHz to 880 MHz	Level reduced by 5 dB

Frequency band	GSM 850 MS		GSM 850 and MXM 850 BTS		MXM 1900 BTS	
	dB $\mu$ V (emf)	dBm	dB $\mu$ V (emf)	dBm	dB $\mu$ V (emf)	dBm
in-band						
600 kHz $\leq  f-f_0  < 800$ kHz	70	-43	76	-37	70	-43
800 kHz $\leq  f-f_0  < 1,6$ MHz	70	-43	78	-35	75	-38
1,6 MHz $\leq  f-f_0  < 3$ MHz	80	-33	80	-33	80	-33
3 MHz $\leq  f-f_0 $	90	-23	80	-33	80	-33
out-of-band						
(a)	113	0	121	8	113	0
(b)	-	-	-	-	-	-
(c)	-	-	-	-	-	-
(d)	113	0	121	8	113	0

The blocking characteristics of the micro-BTS receiver are specified for in-band and out-of-band performance. The out-of-band blocking remains the same as a normal BTS and the in-band blocking performance shall be no worse than in the table below.

Frequency band	GSM 900, GSM 850 and MXM 850 micro and pico-BTS				DCS 1800, PCS 1900 and MXM 1900 micro and pico-BTS			
	M1 (dBm)	M2 (dBm)	M3 (dBm)	P1 (dBm)	M1 (dBm)	M2 (dBm)	M3 (dBm)	P1 (dBm)
in-band								
600 kHz $\leq  f-f_0  < 800$ kHz	-31	-26	-21	-34	-40	-35	-30	-41
800 kHz $\leq  f-f_0  < 1,6$ MHz	-21	-16	-11	-34	-30	-25	-20	-41
1,6 MHz $\leq  f-f_0  < 3$ MHz	-21	-16	-11	-26	-30	-25	-20	-31
3 MHz $\leq  f-f_0 $	-21	-16	-11	-18	-30	-25	-20	-23

The blocking performance for the pico-BTS attempts, for the scenario of a close proximity uncoordinated MS, to balance the impact due to blocking by the MS with that due to wideband noise overlapping the wanted signal.

### 6.1.1 GMSK modulation

Under the following propagation conditions and with an input level of 20 dB above the reference sensitivity level, the chip error rate, equivalent to the bit error rate of the non protected bits (e.g. CS-4) shall have the following limits:

- static channel: BER  $\leq 10^{-4}$ ;
- EQ50 channel: BER  $\leq 3\%$ ;

except for 3GPP TS 400, where the following limits applies:

- static channel: BER  $\leq 10^{-4}$ ;
- EQ100 channel: BER  $\leq 3\%$ .

For the pico-BTS the nominal error rates need only be met in the static channel.

This performance shall be maintained up to -40 dBm input level for static and multipath conditions.

This performance shall also be maintained by the MS under frequency hopping conditions, for input levels up to -40 dBm in timeslots on the C0 carrier, with equal input levels in timeslots on non C0 carriers up to 30 dB less than on the C0 carrier.

NOTE: This scenario may exist when BTS downlink power control and frequency hopping are used.

Furthermore, for static conditions, a bit error rate of  $10^{-3}$  shall be maintained up to -15 dBm for GSM 400, GSM 900, GSM 850 MS and GSM 400, GSM 900, GSM 850, MXM 850 BTS, -23 dBm for DCS 1800, PCS 1900 MS and DCS 1800, PCS 1900, MXM 1900 BTS.

For static conditions, a bit error rate of  $10^{-3}$  shall also be maintained by the MS under frequency hopping conditions, for input levels on the C0 carrier of up to -15 dBm for GSM 400, GSM 900, and GSM 850, -23 dBm for DCS 1800 and PCS 1900, with equal input levels on non C0 carriers, up to 30 dB less than on the C0 carrier.

For pico-BTS, for static conditions, a bit error rate of  $10^{-3}$  shall be maintained with input levels up to -5 dBm for GSM 900, GSM 850 and MXM 850, and -14 dBm for DCS 1800, PCS 1900 and MXM 1900.

## 6.2 Reference sensitivity level

The reference sensitivity performance in terms of frame erasure, bit error, or residual bit error rates (whichever appropriate) is specified in table 1, according to the type of channel and the propagation condition. The performance requirements for GSM 400 systems are as for GSM 900 in table 1, except that the GSM 400 MS speed is doubled from that of GSM 900, e.g. TU50 becomes TU100.

NOTE: For conformance testing purposes using requirements at double speed is considered sufficient to verify MS behaviour at realistic speeds. This applies for packet channels and reference interference performance as well.

The actual sensitivity level is defined as the input level for which this performance is met. The actual sensitivity level shall be less than a specified limit, called the reference sensitivity level. The reference sensitivity level shall be:

GSM 400 MS	-	for GSM 400 small MS	-102 dBm
	-	for other GSM 400 MS	-104 dBm
GSM 400 BTS	-	for normal BTS	-104 dBm
GSM 900 MS	-	for GSM 900 small MS	-102 dBm
	-	for other GSM 900 MS	-104 dBm

GSM 850 MS	-	for GSM 850 small MS	-102 dBm
	-	for other GSM 850 MS	-104 dBm
DCS 1800 MS	-	for DCS 1800 class 1 or class 2 MS	-100 / -102 dBm *
	-	for DCS 1800 class 3 MS	-102 dBm
PCS 1900 MS	-	for PCS 1900 class 1 or class 2 MS	-102 dBm
	-	for other PCS 1900 MS	-104 dBm
GSM 900 BTS, GSM 850 BTS and MXM 850	-	for normal BTS	-104 dBm
	-	for micro BTS M1	-97 dBm
	-	for micro BTS M2	-92 dBm
	-	for micro BTS M3	-87 dBm
	-	for pico BTS P1	-88 dBm
DCS 1800 BTS	-	for normal BTS	-104 dBm
	-	for micro BTS M1	-102 dBm
	-	for micro BTS M2	-97 dBm
	-	for micro BTS M3	-92 dBm
	-	for pico BTS P1	-95 dBm
PCS 1900 BTS and MXM 1900	-	for normal BTS	-104 dBm
	-	for micro BTS M1	-102 dBm
	-	for micro BTS M2	-97 dBm
	-	for micro BTS M3	-92 dBm
	-	for pico BTS P1	-95 dBm

\* For all DCS 1800 class 1 and class 2 MS to be type approved after 1st December 1999, the -102 dBm level shall apply for the reference sensitivity performance as specified in table 1 for the normal conditions defined in annex D and -100 dBm level shall be used to determine all other MS performances.

For packet switched channels, the minimum input signal level for which the reference performance shall be met is specified in table 1a for GMSK modulated input signals, and tables 1b and 1c for 8-PSK modulated input signals respectively, according to the type of channel and the propagation condition. The performance requirements for GSM 400 systems are as for GSM 900 in tables 1a, 1b and 1c, except that the GSM 400 MS speed is doubled from that of GSM 900, e.g. TU50 becomes TU100. The levels are given for normal BTS for GMSK modulated signals. For 8-PSK modulated signals, the required levels are given for normal BTS and MS separately. The levels shall be corrected by the following values:

	<b>MS, GMSK modulated signals</b>	
-	for DCS 1800 class 1 or class 2 MS	+2/+4 dB
		**
-	for DCS 1800 class 3 MS	+2 dB
-	for GSM 400 small MS, GSM 900 small MS and GSM 850 small MS	+2 dB
-	for other GSM 400, GSM 900 MS and GSM 850 MS	0 dB
	for PCS 1900 class 1 or class 2 MS	+2 dB
	for other PCS 1900 MS	0 dB
	<b>MS, 8-PSK modulated signals</b>	
-	for GSM 400, GSM 900 and GSM 850 small MS	0 dB
-	for other GSM 400, GSM 900 and GSM 850 MS	-2 dB
-	for DCS 1800 and PCS 1900 class 1 or class 2 MS	0 dB
-	for other DCS 1800 and PCS 1900 MS	-2 dB

<b>BTS</b>		
-	for normal BTS	0 dB
-	for GSM 900, GSM 850 and MXM 850 micro BTS M1	+7 dB
-	for GSM 900, GSM 850 and MXM 850 micro BTS M2	+12 dB
-	for GSM 900, GSM 850 and MXM 850 micro BTS M3	+17 dB
-	for GSM 900, GSM 850 and MXM 850 pico BTS P1	+16 dB
-	for DCS 1800, PCS 1900 and MXM 1900 micro BTS M1	+2 dB
<b>BTS</b>		
-	for DCS 1800, PCS 1900 and MXM 1900 micro BTS M2	+7 dB
-	for DCS 1800, PCS 1900 and MXM 1900 micro BTS M3	+12 dB
-	for DCS 1800, PCS 1900 and MXM 1900 pico BTS P1	+9 dB

\*\* For all DCS 1800 class 1 and class 2 MS, a correction offset of +2dB shall apply for the reference sensitivity performance as specified in table 1a for the normal conditions defined in annex D and an offset of +4 dB shall be used to determine all other MS performances.

The reference performance shall be:

-	for packet data channels (PDCH)	BLER ≤ 10 %
-	for uplink state flags (USF)	BLER ≤ 1 %
-	for packet random access channels (PRACH),	BLER ≤ 15 %

where BLER is the Block Error Rate, referring to all erroneously decoded data blocks including any headers, stealing flags, parity bits as well as any implicit information in the training sequence. For PDCH the BLER refers to RLC blocks, and hence there can be up to two block errors per 20 ms radio block for EGPRS MCS7, MCS8 and MCS9. For USF, the BLER only refers to the USF value.

For 8-PSK modulated PDCH channels, the performance requirements for some coding schemes and propagation conditions are specified at higher BLER. Where applicable, the BLER value noted in table 1b and 1c applies.

The reference sensitivity performance specified above need not be met in the following cases:

- for BTS if the received level on either of the two adjacent timeslots to the wanted exceed the wanted timeslot reference sensitivity level by more than 50 dB;
- for MS at the static channel, if the received level on either of the two adjacent timeslots to the wanted exceed the wanted timeslot reference sensitivity level by more than 20 dB;
- for MS on a multislot configuration, if the received level on any of the timeslots belonging to the same multislot configuration as the wanted time slot, exceed the wanted time slot by more than 6 dB.

The interfering adjacent time slots shall be static with valid GSM GMSK signals in all cases. The reference sensitivity levels, specified above for circuit-switched, GMSK-modulated channels, apply to 8-PSK as well.

The requirements for micro-BTS for 8-PSK modulated input signals in the tables above, assume the same maximum output power in GMSK and 8-PSK. For other maximum output power levels, the sensitivity is adjusted accordingly.

The pico-BTS 900 MHz, 1800 MHz, 1900 MHz and 850 MHz shall meet the reference sensitivity performance specified for the static channel. The only other channel that is specified is the TI5 propagation condition and this need only be tested for the no FH case. The performance requirement for GSM 900, GSM 850, DCS 1800, PCS 1900, MXM 850 and MXM 1900 pico-BTS with the TI5 propagation condition is the same as the TU50 performance requirement for GSM 900. The level of input signal at which this requirement shall be met is 3dB above the level specified above in this clause (in combination with tables 1a and 1b for packet service), for GMSK modulated signals, and 3 dB for 8-PSK modulated signals.



## 6.3 Reference interference level

The reference interference performance (for cochannel, C/Ic, or adjacent channel, C/Ia) in terms of frame erasure, bit error or residual bit error rates (whichever appropriate) is specified in table 2, according to the type of channel and the propagation condition. The performance requirements for GSM 400 systems are as for GSM 900 in table 2, except that the GSM 400 MS speed is doubled from that of GSM 900, e.g. TU50 becomes TU100. The actual interference ratio is defined as the interference ratio for which this performance is met. The actual interference ratio shall be less than a specified limit, called the reference interference ratio. The reference interference ratio shall be, for BTS and all types of MS:

-	for cochannel interference	C/Ic	=	9 dB
-	for adjacent (200 kHz) interference	C/Ia1	=	-9 dB
-	for adjacent (400 kHz) interference	C/Ia2	=	-41 dB
-	for adjacent (600 kHz) interference	C/Ia3	=	-49 dB

For GMSK modulated channels, packet switched and ECSD, and for 8-PSK modulated channels, packet switched and ECSD, the minimum interference ratio for which the reference performance for cochannel interference (C/Ic) shall be met is specified in table 2a, 2d and 2e (GMSK), 2b and 2c, 2d and 2e (8-PSK) respectively, according to the type of channel, the propagation condition and type of equipment. The performance requirements for GSM 400 systems are as for GSM 900 in table 2a, 2b, 2c, 2d and 2e except that the GSM 400 MS speed is doubled from that of GSM 900, e.g. U50 becomes TU100. The reference performance is the same as defined in clause 6.2. For equipment supporting 8-PSK, the requirements apply for both GMSK and 8-PSK modulated interfering signals. The corresponding interference ratio for adjacent channel interference shall be:

Modulation of wanted signal		GMSK	8-PSK
- for adjacent (200 kHz) interference	C/Ia1 =	C/Ic - 18 dB	see tables 2f, 2g, 2h and 2i
- for adjacent (400 kHz) interference	C/Ia2 =	C/Ic - 50 dB	C/Ic - 50 dB
- for adjacent (600 kHz) interference	C/Ia3 =	C/Ic - 58 dB	C/Ic - 58 dB

NOTE: The C/Ia3 figure is given for information purposes and will not require testing. It was calculated for the case of an equipment with an antenna connector, operating at output power levels of +33 dBm and below. Rejection of signals at 600 kHz is specified in clause 5.1.

The values in tables 2f, 2g, 2h and 2i are also valid for GSM 400 with the exception that MS speed is doubled, e.g. TU50 becomes TU100.

These specifications apply for a wanted signal input level of 20 dB above the reference sensitivity level, and for a random, continuous, GSM-modulated interfering signal. For packet switched, GMSK modulated channels the wanted input signal level shall be:  $-93 \text{ dBm} + I_r + \text{Corr}$ , where:

$I_r$  = the interference ratio according to table 2a

Corr = the correction factor for reference performance according to clause 6.2.

For ECSD channels and 8-PSK modulated packet-switched channels, the wanted input signal level shall be:  $-93 \text{ dBm} + I_r + \text{Corr}$ , where:

$I_r$  = the interference ratio according to table 2b and 2c for packets switched channels and table 2d and 2e for ECSD

Corr = the correction factor for reference performance according to clause 6.2

In case of frequency hopping, the interference and the wanted signals shall have the same frequency hopping sequence. In any case the wanted and interfering signals shall be subject to the same propagation profiles (see annex C), independent on the two channels.

For a GSM 400 MS, a GSM 900 MS, a GSM 850, a DCS 1800 MS and a PCS 1900 MS the reference interference performance according to table 2 for co-channel interference (C/Ic) shall be maintained for RA500/250/130 propagation conditions if the time of arrival of the wanted signal is periodically alternated by steps of  $8 \mu\text{s}$  in either direction. The period shall be 32 seconds (16 seconds with the early and 16 seconds with the late time of arrival alternately).

For pico-BTS, propagation conditions other than static and T15 are not specified and only the no FH case need be tested. The performance requirement for GSM 900, GSM 850, DCS 1800, PCS 1900, MXM 850 and MXM 1900 pico-BTS with T15 propagation condition is the same as the TU50 no FH (900 MHz) performance requirement. The interference ratio at which this requirement shall be met is, for GMSK modulated wanted signals, 4 dB above the interference ratio specified above in this clause (in combination with table 2a for packet service). For 8-PSK modulated wanted signals, the interference ratio for this requirement is 4 dB above the interference ratio specified above in this clause (in combination with table 2b, 2c, 2d and 2e for packet service). For adjacent channel interference propagation conditions other than TU50 need not be tested. There is an exception in the case of the pico-BTS in that the specified propagation condition is T15 instead of TU50; the respective test for pico-BTS is described in the paragraph following the table below. If, in order to ease measurement, a TU50 (no FH) faded wanted signal, and a static adjacent channel interferer are used, the reference interference performance shall be:

	GSM 850 and GSM 900	DCS 1800 and PCS 1900
FACCH (FER):	17,1 %	6,1 %

For pico-BTS, adjacent channel and cochannel interference propagation conditions other than T15 need not be tested. If, in order to ease adjacent channel measurements, a T15 (no FH) faded wanted signal, and a static adjacent channel interferer are used, the interference performance shall be the same as that specified above for a TU50 no FH channel (900 MHz). The interference ratio at which this performance shall be met is 4 dB above the reference interference ratio specified above in this clause.

## 6.4 Erroneous frame indication performance

- e) For a BTS on a RACH or PRACH with a random RF input, the overall reception performance shall be such that less than 0,02 % of frames are assessed to be error free.
- f) For a BTS on a PRACH with a random RF input, the overall reception performance shall be such that less than 0,02 % of frames are assessed to be error free.
- g) For an MS allocated a USF on a PDCH with a random RF input or a valid PDCH signal with a random USF not equal to the allocated USF, the overall reception shall be such that the MS shall detect the allocated USF in less than 1 % of the radio blocks, for GMSK modulated signals and 1 % for 8-PSK modulated signals. This requirement shall be met for all input levels up to -40 dBm for GMSK modulated signal, and up to -40 dBm for 8-PSK modulated signals.

## 6.7 Incremental Redundancy Performance for EGPRS MS

Support for Incremental Redundancy reception is mandatory for all EGPRS capable MSs. In Incremental Redundancy RLC mode soft information from multiple, differently punctured, versions of an RLC data block may be used when decoding the RLC data block. This significantly increases the link performance.

An EGPRS capable MS shall under the conditions stated in the below table achieve a long-term throughput of 20 kbit/s per time slot (see note), measured between LLC and RLC/MAC layer.

Required throughput	20,0 kbit/s per timeslot
Propagation conditions	Static, input level -97,0 dBm
Modulation and Coding Scheme	MCS-9
Acknowledgements polling period	32 RLC data blocks
Roundtrip time	120 ms
Number of timeslots	Maximum capability of the MS
Transmit window size	Maximum for the MS timeslot capability

NOTE: This corresponds to an equivalent block error rate of approximately 0,66 using the prescribed MCS-9.

Table 1: Reference sensitivity performance

GSM 850 and GSM 900						
Type of Channel		Propagation conditions				
		static	TU50 (no FH)	TU50 (ideal FH)	RA250 (no FH)	HT100 (no FH)
FACCH/H	(FER)	0,1 %	6,9 %	6,9 %	5,7 %	10,0 %
FACCH/F	(FER)	0,1 %	8,0 %	3,8 %	3,4 %	6,3 %
SDCCH	(FER)	0,1 %	13 %	8 %	8 %	12 %
RACH	(FER)	0,5 %	13 %	13 %	12 %	13 %
SCH	(FER)	1 %	16 %	16 %	15 %	16 %
FACCH/H	(FER)	0,1 %	7,2 %	7,2 %	5,7 %	10,4 %
FACCH/F	(FER)	0,1 %	3,9 %	3,9 %	3,4 %	7,4 %
SDCCH	(FER)	0,1 %	9 %	9 %	8 %	13 %
RACH	(FER)	0,5 %	13 %	13 %	12 %	13 %
SCH	(FER)	1 %	19 %	19 %	15 %	25 %

NOTE 1: The specification for SDCCH applies also for BCCH, AGCH, PCH, SACCH. The actual performance of SACCH, should be better.

NOTE 2: Definitions:  
 FER: Frame erasure rate (frames marked with BFI=1)  
 UFR: Unreliable frame rate (frames marked with (BFI or UFI)=1)  
 EVSIDR: Erased Valid SID frame rate (frames marked with (SID=0) or (SID=1) or ((BFI or UFI)=1) if a valid SID frame was transmitted)  
 ESIDR: Erased SID frame rate (frames marked with SID=0 if a valid SID frame was transmitted)  
 BER: Bit error rate  
 RBER, BFI=0: Residual bit error rate (defined as the ratio of the number of errors detected over the frames defined as "good" to the number of transmitted bits in the "good" frames).  
 RBER, (BFI or UFI)=0: Residual bit error rate (defined as the ratio of the number of errors detected over the frames defined as "reliable" to the number of transmitted bits in the "reliable" frames).  
 RBER, SID=2 and (BFI or UFI)=0: Residual bit error rate of those bits in class I which do not belong to the SID codeword (defined as the ratio of the number of errors detected over the frames that are defined as "valid SID frames" to the number of transmitted bits in these frames, under the condition that a valid SID frame was sent).  
 RBER, SID=1 or SID=2: Residual bit error rate of those bits in class I which do not belong to the SID codeword (defined as the ratio of the number of errors detected over the frames that are defined as "valid SID frames" or as "invalid SID frames" to the number of transmitted bits in these frames, under the condition that a valid SID frame was sent).

NOTE 3:  $1 \leq \alpha \leq 1,6$ . The value of  $\alpha$  can be different for each channel condition but must remain the same for FER and class Ib RBER measurements for the same channel condition.

NOTE 4: FER for CCHs takes into account frames which are signalled as being erroneous (by the FIRE code, parity bits, or other means) or where the stealing flags are wrongly interpreted.

NOTE 5: Ideal FH case assumes perfect decorrelation between bursts. This case may only be tested if such a decorrelation is ensured in the test. For TU50 (ideal FH), sufficient decorrelation may be achieved with 4 frequencies spaced over 5 MHz.

NOTE 6: For AMR, the complete conformance should not be restricted to the channels identified with (\*).

Table 2: Reference interference performance

GSM 850 and GSM 900						
Type of channel		Propagation conditions				
		TU3 (no FH)	TU3 (ideal FH)	TU50 (no FH)	TU50 (ideal FH)	RA250 (no FH)
FACCH/H	(FER)	22 %	6,7 %	6,7 %	6,7 %	5,7 %
FACCH/F	(FER)	22 %	3,4 %	9,5 %	3,4 %	3,5 %
SDCCH	(FER)	22 %	9 %	13 %	9 %	8 %
RACH	(FER)	15 %	15 %	16 %	16 %	13 %
SCH	(FER)	17 %	17 %	17 %	17 %	18 %
FACCH/H	(FER)	22 %	6,7 %	6,9 %	6,9 %	5,7 %
FACCH/F	(FER)	22 %	3,4 %	3,4 %	3,4 %	3,5 %
SDCCH	(FER)	22 %	9 %	9 %	9 %	8 %
RACH	(FER)	15 %	15 %	16 %	16 %	13 %
SCH	(FER)	17 %	17 %	19 %	19 %	18 %

NOTE 1: The specification for SDCCH applies also for BCCH, AGCH, PCH, SACCH. The actual performance of SACCH, particularly for the C/I TU3 (no FH) and TU1,5 (no FH) cases should be better.

NOTE 2: Definitions:  
 FER: Frame erasure rate (frames marked with BFI=1)  
 FER at -3 dB: Frame erasure rate for an input signal level 3 dB below the reference interference level  
 FER at +3 dB: Frame erasure rate for an input signal level 3 dB above the reference interference level  
 UFR: Unreliable frame rate (frames marked with (BFI or UFI)=1)  
 EVSIDR: Erased Valid SID frame rate (frames marked with (SID=0) or (SID=1) or ((BFI or UFI)=1) if a valid SID frame was transmitted)  
 ESIDR: Erased SID frame rate (frames marked with SID=0 if a valid SID frame was transmitted)  
 BER: Bit error rate  
 RBER, BFI=0: Residual bit error rate (defined as the ratio of the number of errors detected over the frames defined as "good" to the number of transmitted bits in the "good" frames).  
 RBER at -3 dB: Residual bit error rate for an input signal level 3 dB below the reference interference level  
 RBER at +3 dB: Residual bit error rate for an input signal level 3 dB above the reference interference level  
 RBER, (BFI or UFI)=0: Residual bit error rate (defined as the ratio of the number of errors detected over the frames defined as "reliable" to the number of transmitted bits in the "reliable" frames).  
 RBER, SID=2 and (BFI or UFI)=0: Residual bit error rate of those bits in class I which do not belong to the SID codeword (defined as the ratio of the number of errors detected over the frames that are defined as "valid SID frames" to the number of transmitted bits in these frames, under the condition that a valid SID frame was sent).  
 RBER, SID=1 or SID=2: Residual bit error rate of those bits in class I which do not belong to the SID codeword (defined as the ratio of the number of errors detected over the frames that are defined as "valid SID frames" or as "invalid SID frames" to the number of transmitted bits in these frames, under the condition that a valid SID frame was sent).

NOTE 3:  $1 \leq \alpha \leq 1,6$ . The value of  $\alpha$  can be different for each channel condition but must remain the same for FER and class Ib RBER measurements for the same channel condition.

NOTE 4: FER for CCHs takes into account frames which are signalled as being erroneous (by the FIRE code, parity bits, or other means) or where the stealing flags are wrongly interpreted.

NOTE 5: Ideal FH case assumes perfect decorrelation between bursts. This case may only be tested if such a decorrelation is ensured in the test. For TU50 (ideal FH), sufficient decorrelation may be achieved with 4 frequencies spaced over 5 MHz. The TU3 (ideal FH) and TU1,5 (ideal FH), sufficient decorrelation cannot easily be achieved. These performance requirements are given for information purposes and need not be tested.

NOTE 6: For AMR, the complete conformance should not be restricted to the channels identified with (\*).

---

## Annex G (normative): Modification to GSM 05.08

This annex details the modified clauses of GSM 05.08 which are applicable to TAPS.

All references to other GSM standards and specifications are to the standards as modified by the present document.

Where the following channel names appear in diagrams, they should be treated as if they had been deleted.

- CTSARCH
- CTSAGCH
- CTSBCH
- CTSPCH
- TCH/EF
- TCH/AFS
- TCH/AHS
- TCH/HS
- TCH/EFS
- TCH/AF
- TCH/AH
- TCH/FS
- E-TCH/F followed by a data rate
- TCH/F followed by a data rate
- TCH/H followed by a data rate
- HSCSD
- ECSD
- NCH

The following clauses have the same numbering as in GSM 05.08.

---

## 2 General

The radio sub-system link control aspects that are addressed are as follows:

- Handover;
- Radio link Failure;
- Cell selection and re-selection in Idle mode, in Group Receive mode and in GPRS mode (see 3GPP TS 03.22).

Handover is required to maintain a call in progress as a MS engaged in a point-to-point call passes from one cell coverage area to another and may also be employed to meet network management requirements, e.g. relief of congestion.

Handover may occur during a call from one TCH to another TCH. It may also occur from DCCH to DCCH or from DCCH to one or multiple TCH(s), e.g. during the initial signalling period at call set-up.

The handover may be either from channel(s) on one cell to other channel(s) on a surrounding cell, or between channels on the same cell which are carried on the same frequency band. Examples are given of handover strategies, however, these will be determined in detail by the network operator.

For a multiband MS, specified in 3GPP TS 02.06, the handover described is also allowed between any channels on different cells which are carried on different frequency bands, e.g. between a GSM 400/TCH, a GSM 900/TCH and a DCS 1800/TCH. Handover between two co-located cells, carried on different frequency bands, is considered as inter-cell handover irrespective of the handover procedures used.

For a multi-RAT MS, i.e. an MS supporting multiple radio access technologies, handover is allowed between GSM and other radio access technologies.

Adaptive control of the RF transmit power from an MS and optionally from the BSS is implemented in order to optimize the uplink and downlink performance and minimize the effects of co-channel interference in the system.

The criteria for determining radio link failure are specified in order to ensure that calls which fail either from loss of radio coverage or unacceptable interference are satisfactorily handled by the network. Radio link failure may result in either re-establishment or release of the call in progress.

Procedures for cell selection and re-selection whilst in Idle mode (i.e. not actively processing a call), are specified in order to ensure that a mobile is camped on a cell with which it can reliably communicate on both the radio uplink and downlink. The operations of an MS in Idle Mode are specified in 3GPP TS 03.22.

Cell re-selection is also performed by the MS when attached to GPRS. Optional procedures are also specified for network controlled cell re-selection for GPRS. Cell re-selection for GPRS is defined in clause 10.1.

For a multi-RAT MS, cell selection and re-selection is allowed between GSM and other radio access technologies.

Information signalled between the MS and BSS is summarized in tables 1, 2 and 3. A full specification of the Layer 1 header is given in 3GPP TS 04.04, and of the Layer 3 fields in 3GPP TS 04.18 and 3GPP TS 04.60.

For COMPACT, specific procedures are defined in clause 12.

### 3.3 BSS measurement procedure

A procedure shall be implemented in the BSS by which it monitors the uplink RX signal level and quality from each MS being served by the cell. A procedure shall be implemented by which the BSS monitors the levels of interference on its idle traffic channels.

### 3.4 Strategy

The handover strategy employed by the network for radio link control determines the handover decision that will be made based on the measurement results reported by the MS/BSS and various parameters set for each cell. Network directed handover may also occur for reasons other than radio link control, e.g. to control traffic distribution between cells. The exact handover strategies will be determined by the network operator, a detailed example of a basic overall algorithm appears in annex A. Possible types of handover are as follows:

- Inter-cell handover:

Intercell handover from the serving cell to a surrounding cell will normally occur either when the handover measurements show low RXLEV and/or RXQUAL on the current serving cell and a better RXLEV available from a surrounding cell, or when a surrounding cell allows communication with a lower TX power level. This typically indicates that an MS is on the border of the cell area.

Intercell handover may also occur from the DCCH on the serving cell to a TCH on another cell during call establishment. This may be used as a means of providing successful call establishment when no suitable TCH resource is available on the current serving cell.

Inter-cell handover between cells using different frequency bands is allowed for a multi band MS.

Inter-cell handover between cells using different radio access technologies is allowed for a multi-RAT MS.

- Intra-cell handover:

Intra-cell handover from one channel/timeslot configuration in the serving cell to another channel/timeslot configuration in the same cell will normally be performed if the handover measurements show a low RXQUAL, but a high RXLEV on the serving cell. This indicates a degradation of quality caused by interference even though the MS is situated within the serving cell. The intra-cell handover should provide a channel with a lower level of interference. Intra-cell handover can occur either to a timeslot on a new carrier or to a different timeslot on the same carrier.

Intra-cell handover from one of the bands of operation to another one is allowed for a multiband MS.

3GPP TS 08.08 defines the causes for handover that may be signalled from BSS to MSC.

## 4.2 MS implementation

RF power control shall be implemented in the MS.

The power control level to be employed by the MS on each uplink channel, except PDCH, is indicated by means of the power control information sent either in the layer 1 header of each SACCH message block (see 3GPP TS 04.04) on the corresponding downlink channel, or in a dedicated signalling block (see 3GPP TS 04.18). Power control for PDCH is defined in clause 10.2.

The MS shall employ the most recently commanded power control level appropriate to each channel for all transmitted bursts on either a TCH (including handover access burst), FACCH, SACCH or SDCCH.

The MS shall confirm the power control level that it is currently employing in the SACCH L1 header on each uplink channel. The indicated value shall be the power control level actually used by the mobile for the last burst of the previous SACCH period.

When on an E-TCH, the MS shall, if so indicated by the BSS in the SACCH L1 header (see 3GPP TS 04.04) or Assignment command (see 3GPP TS 04.18), use FPC (fast power control). The MS shall employ the most recently commanded fast power control level on each uplink E-TCH channel. The power control level to be employed by the MS is indicated by means of the power control information sent via E-IACCH once every FPC reporting period (see clause 4.7). If FPC is in use, the MS shall report, in the SACCH L1 header, the power control level used at the end of the normal power control reporting period.

When on an E-TCH using 8 PSK for the uplink, the MS shall use the E-IACCH in the uplink for fast measurement reporting.

NOTE: The term "normal power control" is used in this specification only for clarification and is otherwise only referred to as "power control".

When accessing a cell on the RACH (random access) and before receiving the first power command during a communication on a DCCH or TCH (after an IMMEDIATE ASSIGNMENT), all GSM and class 1 and class 2 DCS 1800 MS shall use the power level defined by the MS\_TXPWR\_MAX\_CCH parameter broadcast on the BCCH of the cell. The class 3 DCS 1800 MS shall use the power level defined by MS\_TXPWR\_MAX\_CCH plus the value POWER\_OFFSET also broadcast on the BCCH of the cell.

If a power control level defined in 3GPP TS 05.05 is received but the level is not supported by the MS, the MS shall use the supported output power which is closest to the output power indicated by the received power control level.

## 4.3 MS power control range

The range over which an MS shall be capable of varying its RF output power shall be from its maximum output down to its minimum, in steps of nominally 2 dB.

3GPP TS 05.05 gives a detailed definition of the RF power level step size and tolerances.

The possible DL power control commands are listed in the following table.

Codeword	Power control command
0	Not used
1	Increase output power by four power control levels
2	Increase output power by three power control levels
3	Increase output power by two power control levels
4	Increase output power by one power control level
5	No output power level change
6	Decrease output power by one power control level
7	Decrease output power by two power control levels

If a power control command is received but the requested output power is not supported by the MS, the MS shall use the supported output power which is closest to the requested output power.

## 4.4 BSS implementation

RF power control may optionally be implemented in the BSS.

## 4.7 Timing

Upon receipt of a command from an SACCH to change its power level on the corresponding uplink channel, the MS shall change to the new level at a rate of one nominal 2 dB power control step every 60 ms (13 TDMA frames), i.e. a range change of 15 steps should take about 900 ms. The change shall commence at the first TDMA frame belonging to the next reporting period (as specified in clause 8.4). The MS shall change the power one nominal 2 dB step at a time, at a rate of one step every 60 ms following the initial change, irrespective of whether actual transmission takes place or not.

In case of channel change, the commanded power control level shall be applied on each new channel immediately.

Switching between the normal power control mechanism and FPC shall be done if FPC is enabled or disabled via signalling in the SACCH L1 header. The respective power control mechanism to be used shall then be active as from the first TDMA frame belonging to the next reporting period (see clause 8.4). The initial power control level to be used by the MS immediately after switching shall, in both cases, be the level last commanded by the normal power control mechanism.

The basic timing cycle for the fast power control mechanism is the FPC reporting period of length 4 TDMA frames, which is mapped into the 26-multiframe according to the following figure.

<b>FN:</b>	0	1	2	3	4	5	6	7	8	9	10	11	12	13	14	15	16	17	18	19	20	21	22	23	24	25
<b>RP:</b>	0	0	0	0	1	1	1	1	2	2	2	2	S	3	3	3	3	4	4	4	4	5	5	5	5	I

FN = TDMA Frame no modulo 26  
RP = FPC reporting period number

DL measurements made during RP(n) shall be reported to the network during the next occurrence of RP((n+2) mod 6). Power control commands received from the network during RP(n) are effectuated on the corresponding UL channel during the next occurrence of RP((n+1) mod 6).

## 5.1 Criterion

The criterion for determining Radio Link Failure in the MS shall be based on the success rate of decoding messages on the downlink SACCH.

For GPRS, Radio Link Failure is determined by the RLC/MAC protocol (see 3GPP TS 04.60).



## 5.2 MS procedure

The aim of determining radio link failure in the MS is to ensure that calls with unacceptable quality, which cannot be improved either by RF power control or handover, are either re-established or released in a defined manner. In general the parameters that control the forced release should be set such that the forced release will not normally occur until the call has degraded to a quality below that at which the majority of subscribers would have manually released. This ensures that, for example, a call on the edge of a radio coverage area, although of bad quality, can usually be completed if the subscriber wishes.

The radio link failure criterion is based on the radio link counter S. If the MS is unable to decode a SACCH message (BFI = 1), S is decreased by 1. In the case of a successful reception of a SACCH message (BFI = 0) S is increased by 2. In any case S shall not exceed the value of RADIO\_LINK\_TIMEOUT. If S reaches 0 a radio link failure shall be declared. The action to be taken is specified in 3GPP TS 04.18. The RADIO\_LINK\_TIMEOUT parameter is transmitted by each BSS in the BCCH data (see table 1).

The MS shall continue transmitting as normal on the uplink until S reaches 0.

The algorithm shall start after the assignment of a dedicated channel and S shall be initialized to RADIO\_LINK\_TIMEOUT.

The detailed operation shall be as follows:

- the radio link time-out algorithm shall be stopped at the reception of a channel change command;
- (re-)initialization and start of the algorithm shall be done whenever the MS switches to a new channel (this includes the old channel in assignment and handover failure cases), at the latest when the main signalling link (see 3GPP TS 04.18) has been established;
- the RADIO\_LINK\_TIMEOUT value used at (re-)initialization shall be that used on the previous channel (in the Immediate Assignment case the value received on the BCCH), or the value received on SACCH if the MS has received a RADIO\_LINK\_TIMEOUT value on the new channel before the initialization;
- if the first RADIO\_LINK\_TIMEOUT value on the SACCH is received on the new channel after the initialization, the counter shall be re-initialized with the new value.

## 5.3 BSS procedure

The criteria for determining radio link failure in the BSS should be based upon either the error rate on the uplink SACCH(s) or on RXLEV/RXQUAL measurements of the MS. The exact criteria to be employed shall be determined by the network operator.

Whenever the uplink is not used, the BSS radio link failure procedures shall not apply on that channel.

### 6.6.1 Monitoring of received signal level and BCCH data

Whilst in idle mode an MS shall continue to monitor all BCCH carriers as indicated by the BCCH allocation (BA - see table 1). A running average of received signal level (RLA\_C) in the preceding 5 to:

$$\text{Max } \{5, ((5 * N + 6) \text{ DIV } 7) * \text{BS\_PA\_MFRMS} / 4\}$$

seconds shall be maintained for each carrier in the BCCH allocation. N is the number of non-serving cell BCCH carriers in BA and the parameter BS\_PA\_MFRMS is defined in 3GPP TS 05.02.

The same number of measurement samples shall be taken for all non-serving cell BCCH carriers of the BA list, and the samples allocated to each carrier shall as far as possible be uniformly distributed over each evaluation period. At least 5 received signal level measurement samples are required per RLA\_C value. New sets of RLA\_C values shall be calculated as often as possible.

For the serving cell, received signal level measurement samples shall be taken at least for each paging block of the MS. The RLA\_C shall be a running average determined using samples collected over a period of 5 s to Max {5s, five consecutive paging blocks of that MS}. The samples shall as far as possible be uniformly distributed over each evaluation period. At least 5 received signal level measurement samples are required per RLA\_C value. New RLA\_C values shall be calculated as often as possible.

The list of the 6 strongest non-serving carriers shall be updated at least as often as the duration of the running average defined for measurements on the BCCH allocation and may be updated more frequently.

In order to minimize power consumption, MS that employ DRX (i.e. power down when paging blocks are not due) should monitor the received signal levels of non-serving cell BCCH carriers during the frames of the paging block that they are required to listen to. The MS shall include the BCCH carrier of the current serving cell (i.e. the cell the MS is camped on) in this measurement routine. Received signal level measurement samples can thus be taken on several non-serving cell BCCH carriers and on the serving carrier during each paging block.

The MS shall attempt to decode the full BCCH data of the serving cell at least every 30 seconds.

If SI13 is broadcast, the MS supporting change mark in SI13 (see 3GPP TS 04.18) is only required to confirm system information on the BCCH of the serving cell if indicated by change mark in SI13.

The MS shall attempt to decode the BCCH data block that contains the parameters affecting cell reselection for each of the 6 strongest non-serving cell BCCH carriers at least every 5 minutes. When the MS recognizes that a new BCCH carrier has become one of the 6 strongest, the BCCH data shall be decoded for the new carrier within 30 seconds.

The MS shall attempt to check the BSIC for each of the 6 strongest non-serving cell BCCH carriers at least every 30 seconds, to confirm that it is monitoring the same cell. If a change of BSIC is detected then the carrier shall be treated as a new carrier and the BCCH data re-determined.

In addition, an MS supporting SoLSA with SoLSA subscription shall attempt to decode BSIC and the BCCH data blocks that contain the parameters affecting SoLSA cell reselection for the 6 strongest carriers, which are included both in the BCCH allocation and in the BA\_PREF as received in the latest CHANNEL RELEASE message (see GSM GSM 04.18). At least one carrier shall be searched every 5 minutes, one after another. In the case the MS has been able to decode the BCCH data blocks, the rules described in clause 6.6.3 shall be followed.

When requested by the user, the MS shall determine which PLMNs are available (Manual Mode) or available and allowable (Automatic Mode) (see 3GPP TS 03.22) within 10 seconds (for GSM 450 and TETRA 450), 15 seconds (for GSM 850 and GSM 900) or 20 seconds (for DCS 1800 and PCS 1900). A multi band MS shall perform the same procedures in all bands of operation within the sum of time constraints in the respective band of operation.

In both cases, this monitoring shall be done so as to minimize interruptions to the monitoring of the PCH.

The maximum time allowed for synchronization to a BCCH carrier is 0,5 s, and the maximum time allowed to read the BCCH data, when being synchronized to a BCCH carrier, is 1,9 s. An exception is allowed for system information messages that are broadcast only once every  $n^{\text{th}}$  ( $n > 1$ ) occurrence of the 8 multiframes (see 3GPP TS 05.02). For these system information messages the allowed decoding time is extended according to the applied scheduling of the system information broadcast, i.e.  $n \cdot 1,9$  s.

## 6.7.2 Call re-establishment

In the event of a radio link failure, call re-establishment may be attempted (according to the procedure in 3GPP TS 04.18). The MS shall perform the following algorithm to determine which cell to use for the call re-establishment attempt.

- i) The received signal level measurement samples taken on the carriers indicated in the BA (SACCH) received on the serving cell and on the serving cell BCCH carrier in the last 5 seconds shall be averaged, and the carrier with the highest average received signal level with a permitted NCC as indicated on the SACCH of the serving cell (see clause 7.2) shall be taken.
- ii) On this carrier the MS shall attempt to decode the BCCH data block containing the parameters affecting cell selection.
- iii) If the parameter C1 is greater than zero, it is part of the selected PLMN, the cell is not barred, and call re-establishment is allowed, call re-establishment shall be attempted on this cell.

- iv) If the MS is unable to decode the BCCH data block or if the conditions in iii) are not met, the carrier with the next highest average received signal level with a permitted NCC shall be taken, and the MS shall repeat steps ii) and iii) above.
- v) If the cells with the 6 strongest average received signal level values with a permitted NCC have been tried but cannot be used, the call re-establishment attempt shall be abandoned, and the algorithm of clause 6.7.1 shall be performed.

The MS is under no circumstances allowed to access a cell to attempt call re-establishment later than 20 seconds after the detection within the MS of the radio link failure causing the call re-establishment attempt. In the case where the 20 seconds elapses without a successful call re-establishment the call re-establishment attempt shall be abandoned, and the algorithm of clause 6.7.1 shall be performed.

### 8.2.3 Statistical parameters

For each channel, the measured parameters (RXQUAL) shall be the received signal quality, averaged on that channel over the reporting period of length one SACCH multiframe defined in clause 8.4. In averaging, measurements made during previous reporting periods shall always be discarded.

Contrary to RXLEV measurements, in calculating RXQUAL values, measurements on bursts on the BCCH carrier shall always be included in the averaging process.

For E-TCH the average BER shall for every FPC reporting period be mapped to the RXQUAL scale according to chapter 8.2.4, producing the parameter RXQUAL\_FAST which is reported to the network via E-IACCH.

For TCH, E-TCH, SDCCH, SACCH and FACCH, the MS shall calculate the following values for the last 4 consecutive slots of each fully received and correctly decoded data block (see clause 8.4.8.2):

$MEAN\_BEP_{block} = \text{mean}(BEP)$       Mean Bit Error Probability (BEP) of the block

$CV\_BEP_{block} = \text{std}(BEP)/\text{mean}(BEP)$       Coefficient of Variation of the Bit Error Probability of the block

Here mean(BEP) and std(BEP) are the mean and the standard deviation respectively of the measured BEP values of the 4 consecutive slots, calculated in a linear scale.

The calculated values shall be averaged (on a linear scale) over the reporting period as follows:

$MEAN\_BEP = \text{average of } MEAN\_BEP_{block}$

$CV\_BEP = \text{average of } CV\_BEP_{block}$

In averaging, measurements made during previous reporting periods shall always be discarded.

For EGPRS, the MS shall calculate the following values for each radio block (4 bursts) addressed to it:

$MEAN\_BEP_{block} = \text{mean}(BEP)$       Mean Bit Error Probability (BEP) of a radio block

$CV\_BEP_{block} = \text{std}(BEP)/\text{mean}(BEP)$       Coefficient of variation of the Bit Error Probability of a radio block

Here, mean(BEP) and std(BEP) are the mean and the standard deviation respectively of the measured BEP values of the four bursts in the radio block, calculated in a linear scale.

Filtering and reporting are described in clause 10.2.3.2.

### 8.2.4 Range of parameter RXQUAL

When the quality is assessed over the full-set and sub-set of frames defined in clause 8.4, eight levels of RXQUAL are defined and shall be mapped to the equivalent BER before channel decoding as follows:

RXQUAL_0		BER < 0,2 %	Assumed value =0,14 %
RXQUAL_1	0,2 %	< BER < 0,4 %	Assumed value =0,28 %
RXQUAL_2	0,4 %	< BER < 0,8 %	Assumed value =0,57 %
RXQUAL_3	0,8 %	< BER < 1,6 %	Assumed value =1,13 %
RXQUAL_4	1,6 %	< BER < 3,2 %	Assumed value =2,26 %
RXQUAL_5	3,2 %	< BER < 6,4 %	Assumed value =4,53 %

RXQUAL_6	6,4 %	< BER	< 12,8 %	Assumed value =9,05 %
RXQUAL_7	12,8 %	< BER		Assumed value =18,10 %

The assumed values may be employed in any averaging process applied to RXQUAL.

The same mapping table applies also for RXQUAL\_FAST.

The BER values used to define a quality band are the estimated error probabilities before channel decoding, averaged over the full set or sub set of TDMA frames as defined in clause 8.4. The accuracy to which an MS shall be capable of estimating the error probabilities when on a TCH under static channel conditions is given in the following table.

Quality Band	Range of actual BER	Probability that the correct RXQUAL band is reported by MS shall exceed			
		Full rate Channel	Half rate Channel		
RXQUAL_0	Less than 0,1 %	90 %	90 %		
RXQUAL_1	0,26 % to 0,30 %	75 %	60 %		
RXQUAL_2	0,51 % to 0,64 %	85 %	70 %		
RXQUAL_3	1,0 % to 1,3 %	90 %	85 %		
RXQUAL_4	1,9 % to 2,7 %	90 %	85 %		
RXQUAL_5	3,8 % to 5,4 %	95 %	95 %		
RXQUAL_6	7,6 % to 11,0 %	95 %	95 %		
RXQUAL_7	Greater than 15,0 %	95 %	95 %		

NOTE 1: For the full rate channel RXQUAL\_FULL is based on 104 TDMA frames.  
NOTE 2: For the half rate channel RXQUAL\_FULL is based on 52 TDMA frames.

The accuracy to which an MS shall be capable of estimating the error probabilities when on a TCH under TU50 channel conditions is given in the following table.

Range of actual BER	Expected RXQUAL_FULL	Probability that expected RXQUAL_FULL is reported shall exceed
Less than 0,1 %	RXQUAL_0/1	85 %
0,26 % to 0,30 %	RXQUAL_1/0/2	85 %
0,51 % to 0,64 %	RXQUAL_2/1/3	85 %
1,0 % to 1,3 %	RXQUAL_3/2/4	75 %
1,9 % to 2,7 %	RXQUAL_4/3/5	75 %
3,8 % to 5,4 %	RXQUAL_5/4/6	90 %
7,6 % to 11,0 %	RXQUAL_6/5/7	90 %
Greater than 15,0 %	RXQUAL_7/6	90 %

It should be noted that in the testing, the System Simulator (SS) or (BSSTE) Base Station System Test Equipment will have to measure the average error rate over a large number of TDMA frames.

### 8.4.1 Measurement reporting for the MS on a TCH

For a TCH, the reporting period of length 104 TDMA frames (480 ms) is defined in terms of TDMA frame numbers (FN) as follows:

Timeslot number (TN)			TDMA frame number (FN) modulo 104	
TCH/F	TCH/H,subch.0	TCH/H,subch.1	Reporting period	SACCH Message block
0	0 and 1		0 to 103	12, 38, 64, 90
1		0 and 1	13 to 12	25, 51, 77, 103
2	2 and 3		26 to 25	38, 64, 90, 12
3		2 and 3	39 to 38	51, 77, 103, 25
4	4 and 5		52 to 51	64, 90, 12, 38
5		4 and 5	65 to 64	77, 103, 25, 51
6	6 and 7		78 to 77	90, 12, 38, 64
7		6 and 7	91 to 90	103, 25, 51, 77

When on a TCH, the MS shall assess during the reporting period and transmit to the BSS in the next SACCH message block the following:

- RXLEV for the BCCH carrier of the 6 cells with the highest RXLEV among those with known and allowed NCC part of BSIC. For a multi band MS the number of cells, for each frequency band supported, which shall be included is specified in clause 8.4.3. For a cell of other radio access technology, see clauses 8.1.5 and 8.4.7.

NOTE 1: Since there are 104 TDMA frames in each SACCH multiframe (and measurement in 4 frames is optional), the number of samples on each BCCH carrier will depend on the number of carriers defined in the BCCH Allocation (BA) and may be different. The following table gives examples of this.

Number of BCCH carriers in BCCH Allocation	Number of samples per carrier in SACCH multiframe
32	3-4
16	6-7
10	10-11
8	12-13
⋮	⋮
⋮	⋮

These figures are increased if the MS is able to make measurements on more than one BCCH carrier during each TDMA frame.

- RXLEV\_FULL and RXQUAL\_FULL:  
RXLEV and RXQUAL for the full set of TCH and SACCH TDMA frames. The full set of TDMA frames is either 100 (i.e. 104 - 4 idle) frames for a full rate TCH or 52 frames for a half-rate TCH.
- RXLEV\_SUB and RXQUAL\_SUB:  
RXLEV and RXQUAL for the subset of 4 SACCH frames and the SID TDMA frames/L2 fill frames defined in clause 8.3. If no FACCH frames have been received at the corresponding frame positions, the RXQUAL\_SUB report shall include measurements on the 4 SACCH frames only. The performance requirements of clause 8.2.4 do not apply in this case for RXQUAL\_SUB. In case of half rate traffic channel TCH/H in signalling only mode, -SUB values are set equal to the -FULL values in the SACCH message

NOTE 2: If measurement on the BCCH carrier is not used, the number of TDMA frames used in the RXLEV averaging process may be lower than the number of TDMA frames in the set see clause 8.1.3.

## 8.4.2 Measurement reporting for the MS on a SDCCH

For a SDCCH, the reporting period of length 102 TDMA frames (470,8 ms) is defined in terms of TDMA frame numbers (FN) as follows:

	TDMA frame number (FN) modulo 102
SDCCH/8	12 to 11
SDCCH/4	37 to 36

NOTE 1: Some SDCCH data, data or SID message blocks are spread over two reporting periods. In these cases, the RXLEV and/or RXQUAL information from the SDCCH or TCH message blocks may either be sent as part of the measurement report of the second period, or shared between the reports of the two periods.

When on a SDCCH, the MS shall assess during the reporting period and transmit to the BSS in the next SACCH message block the following:

- RXLEV for the BCCH carrier of the 6 cells with the highest RXLEV among those with known and allowed NCC part of BSIC. For a multi band MS the number of cells, for each frequency band supported, which shall be included is specified in clause 8.4.3. For a cell of other radio access technology, see clauses 8.1.5 and 8.4.7.

NOTE 2: With only 102 TDMA frames in each SACCH multiframe, the number of samples used to calculate RXLEV per BCCH carrier may be slightly different from the case of TCH described above.

- RXLEV and RXQUAL for the full set of 12 (8 SDCCH and 4 SACCH) frames within the reporting period. -SUB values are set equal to the -FULL values in the SACCH message.

NOTE 3: If measurement on the BCCH carrier is not used, the number of TDMA frames used in the RXLEV averaging process may be lower than the number of TDMA frames in the full set see clause 8.1.3.

#### 8.4.4 Common aspects for the MS on a TCH or a SDCCH

Whether the MS is on a TCH or a SDCCH, if an SACCH message block is used for a different Layer 3 message, the measurement report that would otherwise be sent in that block is discarded and a new measurement report provided for the next SACCH message.

The measurements in the MS shall be based on the current BA list and the current NCC\_PERMITTED (see table 1), available at the beginning of the reporting period. At the transition from idle mode to a TCH or a SDCCH the current BA list is the BA(BCCH), later the latest received complete BA(SACCH). A complete BA(SACCH) for a MS shall be that contained in SI 5 and additionally SI 5bis if the EXT-IND bit in the Neighbour Cell Description information element in both the SI 5 and SI 5bis messages indicates that each information element only carries part of the BA. If a SI 5ter message is subsequently received and not ignored (see 3GPP TS 04.18) the BA(SACCH) shall be modified accordingly.

At the transition from idle mode to a TCH or a SDCCH the current NCC is the NCC\_PERMITTED received on the BCCH, later the latest NCC\_PERMITTED received on the SACCH. The measurement process on carriers contained in both lists is, therefore, continuous.

If the current BA list does not refer to the serving cell, e.g. after a handover, this shall be indicated and no measurement values for cells in the BA list shall be reported.

If the MS returns to the previous cell after a failure of the handover procedure the description above applies. As a consequence, a BA list (and/or NCC\_PERMITTED) received on the SACCH in the cell to which the handover failed shall be regarded as the current ones, which may lead to interruptions in the measurement reporting as the BA list does not refer to the serving cell. As an option, the MS may in this case remember the last received BA list and NCC\_PERMITTED in the old cell and regard those as the current ones when returning.

What is said in this clause about the BA list also applies to the GSM neighbour cell list when using enhanced measurement reporting and to the 3G neighbour cell list for a multi-RAT MS. The rules for building of and changing between neighbour cell lists are defined in 3GPP TS 04.18.

#### 8.4.6 Extended measurement reporting

When on a TCH or SDCCH, the mobile station may receive an Extended Measurement Order (EMO) message. The mobile station shall then, during one reporting period, perform received signal level measurements according to the frequency list contained in the EMO message. BSIC decoding is not required for these frequencies. The mobile station shall then transmit the measurement results in one single Extended Measurement Report message, containing the following:

- RXLEV (as defined in clause 8.1.4) for the carriers specified by the last received EMO message. If the EMO contains more than 21 carriers, only the 21 first carriers in the sorted EXTENDED MEASUREMENT FREQUENCY LIST (in the EMO) are measured and reported.

NOTE: the position of the signal strength measurement samples performed by the mobile station, and the duration of these samples are not known in a TDMA frame. Consequently, in case the signal level on the carrier the MS has to monitor is not constant, the MS will report as the RXLEV value, the signal strength measurements performed during its sampling period. This value can be different from the mean value of the signal level on the whole frame.

If reporting is not possible due to requirements to send other Layer 3 messages, the measurements shall either be discarded and new measurements scheduled at the next possible opportunity or saved and transmitted at the next possible opportunity. If extended measurements cannot be reported within 10 seconds after the triggering EMO was received, they shall be discarded (and not reported).

If the EMO message contains frequencies outside the MS' frequency band, the MS shall set the corresponding RXLEV value(s) to zero.

After a successful channel change, no Extended Measurement Report shall be sent if the EMO was received before that channel change.

After having performed Extended Measurements during one reporting period, the mobile station shall resume the measurements according to the current BA list. This applies for each rescheduling of the Extended measurements.

### 8.4.8.2 Measurement Reporting

The reporting period shall be as specified in 8.4.1 for the MS on a TCH and as specified in 8.4.2 for the MS on a SDCCH.

When on a TCH, the MS shall assess during the reporting period and transmit to the BSS in the next SACCH message block the following:

- RXLEV for neighbour cells in the order defined in 8.4.8.1. For a cell of other radio access technology, see clause 8.1.5.
- RXQUAL\_FULL:  
RXQUAL for the full set of TCH and SACCH TDMA frames. The full set of TDMA frames is either 100 (i.e. 104 - 4 idle) frames for a full rate TCH or 52 frames for a half-rate TCH.
- RXLEV\_VAL:  
RXLEV measured on SACCH frames and on the 4 last time slots of each fully received and correctly decoded data block.
- MEAN\_BEP and CV\_BEP:  
The average over the reporting period of the Mean and Coefficient of Variation of the Bit Error Probability measures excluding CV\_BEP<sub>block</sub> measurements from SACCH blocks (see clause 8.2.3).
- NBR\_RCVD\_BLOCKS:  
The number of correctly decoded data blocks, as defined for RXLEV\_VAL, (excluding SACCH) that started during the measurement report period.
- BSIC\_SEEN:  
Indicates if a GSM cell with invalid BSIC but with allowed NCC part of the BSIC is one of the six strongest cells.

When on a SDCCH, the MS shall assess during the reporting period and transmit to the BSS in the next SACCH message block the following:

- RXLEV for neighbour cells as defined in 8.4.8.1. For a cell of other radio access technology, see clause 8.1.5.
- RXLEV\_VAL, NBR\_RCVD\_BLOCKS, RXQUAL\_FULL, MEAN\_BEP and CV\_BEP for the full set of 12 (8 SDCCH and 4 SACCH) TDMA frames within the reporting period. Measurements on all 12 TDMA frames shall be included for RXLEV\_VAL.
- BSIC\_SEEN:  
Indicates if a GSM cell with invalid BSIC but with allowed NCC part of the BSIC is one of the six strongest cells.

The common aspects for the MS on a TCH or a SDCCH as defined in 8.4.4 shall apply.

---

## 9 Control parameters

The parameters employed to control the radio links are shown in tables 1 and 2.

**Table 1: Radio sub-system link control parameters**

Parameter name	Description	Range	Bits	Channel
BSIC	Base station Identification Code	0-63	6	SCH D/L
BA	BCCH Allocation	-	-	BCCH D/L
BA_IND	Sequence number of BA	0/1	1	BCCH D/L
MS_TXPWR_MAX_CCH	The maximum TX power level an MS may use when accessing the system until otherwise commanded.	0/31	5	BCCH D/L

Parameter name	Description	Range	Bits	Channel
POWER OFFSET	The power offset will be used in conjunction with the MS TXPWR MAX CCH parameter by the class 3 DCS 1800 MS: 0 = 0 dB 1 = 2 dB 2 = 4 dB 3 = 6 dB.	0-3	2	BCCH D/L
RXLEV_ACCESS_MIN	Minimum received signal level at the MS required for access to the system.	0-63	6	BCCH D/L
RADIO_LINK_TIMEOUT	The maximum value of the radio link counter 4-64 SACCH blocks, 15 steps of 4 SACCH blocks.	-	4	BCCH D/L SACCH D/L
CELL_RESELECT_HYSTERESIS	RXLEV hysteresis for required cell re-selection. 0-14 dB, 2 dB steps, i.e. 0 = 0 dB, 1 = 2 dB, etc.	0-7	3	BCCH D/L
NCC_PERMITTED	Bit map of NCCs for which the MS is permitted to report measurement results. Bit map relates to NCC part of BSIC.	-	8	BCCH D/L SACCH D/L
CELL_BAR_ACCESS	See table 1a.	0/1	1	BCCH D/L
CELL_BAR_QUALIFY	See table 1a.	0/1	1	BCCH D/L
CELL_BAR_QUALIFY_2	See table 1a.	0-3	2	BCCH D/L
CELL_RESELECT_OFFSET	Applies an offset to the C2 reselection criterion. 0 - 126 dB, 2 dB steps, i.e. 0 = 0 dB, 1 = 2 dB, etc.	0-63	6	BCCH D/L
TEMPORARY_OFFSET	Applies a negative offset to C2 for the duration of PEN/ALTY_TIME. 0 - 60 dB, 10 dB steps i.e. 0 = 0 dB, 1 = 10 dB, etc. and 7 = infinity.	0-7	3	BCCH D/L
PEN/ALTY_TIME	Gives the duration for which the temporary offset is applied. 20 to 620 s, 20 s steps, i.e. 0 = 20 s, 1 = 40 s, etc. 31 is reserved to indicate that CELL_RESELECT_OFFSET is subtracted from C2 and TEMPORARY_OFFSET is ignored.	0-31	5	BCCH D/L
LSA_OFFSET	Applies an offset to be used for LSA cell re-selection between cells with the same LSA priorities. 0 = 0 dB, 1 = 4 dB, 2 = 8 dB, 3 = 16 dB, 4 = 24 dB, 5 = 32 dB, 6 = 48 dB, 7 = 64 dB.	0-7	3	BCCH D/L
PRIO_THR	The PRIO signal strength threshold is related to RXLEV_ACCESS_MIN. 0 = 0 dB, 1 = 6 dB, 2 = 12 dB, 3 = 18 dB 4 = 24 dB, 5 = 30 dB, 6 = 36 dB, 7 = ∞ dB.	0-7	3	BCCH D/L
LSA ID	The LSA identities for the cell			BCCH D/L
Qsearch_I	Search for 3G cells if signal level is below (0-7) or above (8-15) threshold 0 = - 98 dBm, 1 = - 94 dBm, ..., 6 = - 74 dBm, 7 = ∞ (always) 8 = - 78 dBm, 9 = - 74 dBm, ..., 14 = - 54 dBm, 15 = ∞ (never). Default value = ∞ (never).	0-15	4	BCCH D/L
Qsearch_C_Initial	Indicates the Qsearch value to be used in connected mode before Qsearch_C is received, 0 = use Qsearch_I, 1 = ∞ (always). Default value = use Qsearch_I.	0/1	1	BCCH D/L
XXX_Qoffset	Applies an offset to RLA_C for cell re-selection to access technology/mode XXX (one or more) 0 = - ∞ (always select a cell if acceptable), 1 = -28 dB, 2 = -24 dB, ..., 15 = 28 dB. Default value = 0 dB.	0-15	4	BCCH D/L



Parameter name	Description	Range	Bits	Channel
FDD_Qmin	A minimum threshold for Ec/No for UTRAN FDD cell re-selection, 0 = -20 dB, 1 = -19 dB, ..., 7 = -13 dB. Default value = -20 dB.	0-7	3	BCCH D/L

**Table 1a: Parameters affecting cell priority for cell selection**

CELL_BAR_QUALIFY_2	CELL_BAR_QUALIFY	CELL_BAR_ACCESS	Cell selection priority	Status for cell reselection
00	0	0	normal	normal
00	0	1	barred	barred
00	1	0	low	normal (see note 2)
00	1	1	low	normal (see note 2)
10	X	X	normal	normal (see note 3)
11	X	X	low	normal (see note 3)

If all the following conditions are met, then the "Cell selection priority" and the "Status for cell reselection" shall be set to normal:

- the cell belongs to the MS HPLMN;
- the MS is in cell test operation mode;
- the CELL\_BAR\_ACCESS is set to "1";
- the CELL\_BAR\_QUALIFY is set to "0";
- the CELL\_BAR\_QUALIFY\_2 is set to 00;
- the Access Control class 15 is barred.

If the CELL\_BAR\_QUALIFY\_2 parameter has the value 10 or 11, the MS shall ignore the value of CELL\_BAR\_ACCESS and the value of CELL\_BAR\_QUALIFY.

NOTE 1: A low priority cell is only selected if there are no suitable cells of normal priority (see 3GPP TS 03.22).

NOTE 2: Two identical semantics are used for cross phase compatibility reasons. This allows an operator to declare a cell always as a low priority one for a phase 2 MS, but keeps the opportunity for an operator to decide whether a phase 1 MS is permitted to camp on such a cell or not.

NOTE 3: The CELL\_BAR\_QUALIFY\_2 parameter is used for indicating cells without voice support. These cells may be barred for MS prior to release 99, by setting the value of CELL\_BAR\_ACCESS to "1" and the value of CELL\_BAR\_QUALIFY to "0".

**Table 2: Handover and power control parameters - slow ACCH**

Parameter name	Description	Range	Bits	Message
MS_TXPWR_REQUEST (ordered MS power level)	The power level to be used by an MS.	0-31	5	L1 header downlink
MS_TXPWR_CONF. (actual MS power level)	Indication of the power level in use by the MS.	0-31	5	L1 header uplink
POWER_LEVEL	The power level to be used by an MS on the indicated channel.	0-31	5	HO/assignment command
RXLEV_FULL_SERVING_CELL	The RXLEV in the current serving cell accessed over all TDMA frames.	0-63	6	Measurement results
RXLEV_SUB_SERVING_CELL	The RXLEV in the current serving cell accessed over a subset of TDMA frames.	0-63	6	Measurement results
RXQUAL_FULL_SERVING_CELL	The RXQUAL in the current serving cell, assessed over all TDMA frames.	0-7	3	Measurement results
RXQUAL_SUB_SERVING_CELL	The RXQUAL in the current serving a cell, assessed over subset of TDMA frames.	0-7	3	Measurement results
BA_USED	Value of BA_IND for BCCH allocation used.	0/1	1	Measurement results

Parameter name	Description	Range	Bits	Message
RXLEV_NCELL_(1-6)	The RXLEV assessed on BCCH carrier as indicated in the BCCH Allocation.	0-63	6	Measurement results
BCCH_FREQ_NCELL_(1-6)	The BCCH carrier RF channel number in NCELL.	0-31	5	Measurement results
BSIC_NCELL_(1-6)	Base station identification code for NCELL.	0-63	6	Measurement results
MULTIBAND_REPORTING	Indication of the number of cells to be reported for each band in multiband operation.	0-3	2	BCCH D/L SACCH D/L
SCALE	Indication of the offset, which applies for the reported RXLEV values. 0 = 0 dB, 1 = +10 dB.	0-1	1	Enhanced Measurement Report
SCALE_ORD	Indication of the offset, which shall be used for the reported RXLEV values. 0 = +0 dB, 1 = + 10 dB, 2 = automatic Default = 0 dB.	0-2	2	SACCH D/L
Qsearch_C	Search for 3G cells if signal level below threshold (0-7): - 98, - 94, ..., - 74 dBm, ∞ (always) or above threshold (8-15): - 78, - 74, ..., - 54 dBm, ∞ (never).	0-15	4	SACCH D/L
REPORT_TYPE	Indicates which report type the MS shall use, 0 = normal, 1 = enhanced.	0/1	1	SACCH D/L
XXX_MULTIRAT_REPORTING	The number of cells from the access technology/mode XXX (one or more) that shall be included in the list of strongest cells or in the measurement report.	0-3	2	BCCH D/L SACCH D/L
SERVING_BAND_REPORTING	The number of cells from the GSM serving frequency band that shall be included in the list of strongest cells or in the measurement report.	0-3	2	BCCH D/L SACCH D/L
REP_PRIORITY	Indicates the reporting priority per cell, 0 = normal, 1 = high.	0/1	1	SACCH D/L
REPORTING_RATE	Indicates the allowed reporting rate, 0 = normal, 1 = reduced.	0/1	1	SACCH D/L
UNKNOWN_BSIC_REPORTING	Indicates if GSM cells with invalid BSIC but with allowed NCC part may be reported, 0 = no, 1 = yes.	0/1	1	SACCH D/L
XXX_REPORTING_THRESHOLD	Apply priority reporting if the reported value is above threshold for GSM frequency band or access technology/mode XXX (one or more), 0, 6, ..., 36, ∞ (never). Default value = always.	0-7	3	SACCH D/L
XXX_REPORTING_OFFSET	Apply an offset to the reported value when prioritizing the cells for reporting for GSM frequency band or access technology/mode XXX (one or more), 0, 6, ..., 42 dB. Default value = 0 dB.	0-7	3	SACCH D/L
FDD_REP_QUANT	Indicates the reporting quantity for UTRAN FDD cells, 0 = RSCP, 1 = Ec/No	0/1	1	BCCH D/L SACCH D/L
3G_SEARCH_PRIO	Indicates if 3G cells may be searched when BSIC decoding is required, 0 = no, 1 = yes.	0/1	1	SACCH D/L
RTD	The real time difference to other GSM cells, modulo 51 TDMA frames, step: 1 or 1/64 TDMA frame.	0-50 or 0-3 263	6 or 12	SACCH D/L

Parameter name	Description	Range	Bits	Message
NOTE 1: RXLEV and RXQUAL fields are coded as described in clause 8.				
NOTE 2: BCCH_FREQ_NCELL_(1-6) is coded in accordance with 3GPP TS 04.18 as the position in the list of BA carriers.				
NOTE 3: For the details of the Measurement Result message see 3GPP TS 04.18.				

## 10.1 Cell Re-selection

In GPRS Standby and Ready states, cell re-selection is performed by the MS.

The cell re-selection procedures defined in clauses 10.1.1 to 10.1.3 apply to the MSs attached to GPRS if a PBCCH exists in the serving cell.

If PBCCH does not exist, the criteria and algorithms defined in clauses 10.1.2 and 10.1.3 shall also apply if GPRS cell re-selection parameters for one or more cells are provided to the MS in a Packet Cell Change Order or Packet Measurement Order message (see 04.60). In this case, the MS shall convert the idle mode cell re-selection parameters, received for the other cells according to clause 6, to GPRS cell re-selection parameters according to table 3a and use the same procedures, except that the MS may measure received signal strength in packet idle mode according to either clause 6.6.1 or clause 10.1.1.

Otherwise the MS shall perform cell re-selection according to the idle mode procedures defined in clause 6, except that the MS is only required to monitor full system information on BCCH of the serving cell if indicated by change mark on BCCH or PACCH. If PBCCH exists, the MS is not required to monitor system information on BCCH of the serving cell or any system information of the non-serving cells and only required to monitor system information on PBCCH of the serving cell if indicated by change mark on PBCCH, PCCCH or PACCH.

For both cases (with or without PBCCH), the details of system information monitoring are specified in 3GPP TS 04.60.

In packet transfer mode, the MS shall always measure received signal strength according to clause 10.1.1.

In addition, the network may control the cell selection as defined in clause 10.1.4.

The cells to be monitored for cell re-selection are defined in the BA(GPRS) list, which is broadcast on PBCCH. If PBCCH does not exist, BA(GPRS) is equal to BA(BCCH).

For a multi-RAT MS, cell re-selection to other radio access technologies shall also be possible. If PBCCH exists, the procedures in clause 10.1.1.3 and 10.1.3.2 shall apply. Otherwise the idle mode procedures in clause 6 shall apply.

### 10.1.4.3 Exceptional cases

An MS in network control mode NC1 or NC2 may enter any of the following exceptional cases:

- an anonymous access is performed.

In such a case the MS is not required to send measurement reports according to clause 10.1.4.1, and shall not obey any cell re-selection command.

In the anonymous access case the MS shall continue to make measurements and, in mode NC1, perform autonomous cell re-selection, using the current frequency list (NC\_FREQUENCY\_LIST or BA(GPRS)). In mode NC2, the MS shall stay in the current cell until the anonymous access ends. Whenever the exceptional case ends and provided that the MS is still in Ready state, the MS shall resume the latest received network control mode and obey cell re-selection commands. In the anonymous access case, the MS shall continue the ongoing measurements.

### 10.2.3.2.1 Packet transfer mode

In packet transfer mode, the MS shall measure the interference signal level on the same carrier as the assigned PDCHs. The MS shall make these measurements during the search frames and PTCCH frames, which are not required for BSIC decoding or the timing advance procedure. For COMPACT, the MS shall estimate the interference level during PDTCH/PACCH bursts (see annex C).

The MS shall perform interference signal measurements on as many of the channels (timeslots) as possible and as a minimum.

For multislot class type 1 MS (see 3GPP TS 05.02), on the PDCH timeslot numbers TSmin to TSmax, where:

- TSmin = the lowest numbered timeslot allocated for uplink or downlink transfer including downlink PACCH associated with an uplink transfer.
- TSmax = MIN(TSmin + Rx - 1, 7).
- Rx = the maximum number of receive timeslots that the MS can use per TDMA frame according to its multislot class (see 3GPP TS 05.02).

For multislot class type 2 MS (see 3GPP TS 05.02), on the maximum number of receive timeslots (Rx) that the MS can use per TDMA frame according to its multislot class (see 3GPP TS 05.02), in the following priority order, except that no measurements are required on any timeslot number below those with priority 1:

- 1) the PDCH timeslot numbers assigned for downlink transfer including the downlink PACCH associated with an uplink transfer;
- 2) the PDCH timeslot numbers assigned for uplink transfer;
- 3) other timeslots that would be possible to add for downlink transfer to the current allocation according to the MSs multislot class. If more than one combination of timeslots is possible according to this rule, it is implementation dependent which combination to choose.

Interference measurement timeslots have lower priority than real receiver or transmit timeslot and are not compulsory in case of conflict.

For each channel, every measurement  $SS_{CH,n}$  shall consist of the minimum of the two signal level samples from one search frame and one PTCCCH frame. These two measurements should be spaced as closely as possible, but there is no requirement that they shall be contiguous. Thus the SACCH frames are avoided and only the interference is measured. For COMPACT, for each channel, at least two interference measurement samples,  $SS_{CH,n}$ , shall be taken every multiframe

The measured interference shall be averaged in a running average filter:

$$\gamma_{CH,n} = (1-d) * \gamma_{CH,n-1} + d * SS_{CH,n}, \gamma_{CH,0} = 0$$

where d is the forgetting factor:

$$d = 1/\text{MIN}(n, N/A_{VG\_I}).$$

n is the iteration index.

The filter shall be restarted with n=1 for the first sample every time a new cell is selected. If the measurements on a channel is interrupted due to a change of packet mode (transfer or idle), the last obtained n and  $\gamma_{CH,n}$  values shall be saved. When entering packet transfer mode, the filter shall continue from the values obtained during packet idle mode for those channels that are measured in both modes. If frequency hopping is used, channels that only differ in MAIO shall be considered the same. For the other channels, if the measurements are resumed for the same channel within  $N/A_{VG\_I}/2$  multiframes, the filter shall continue from the saved values. Otherwise the filter shall be restarted. Channel reassignment during packet transfer mode shall be considered as start of a new packet transfer mode preceded by a zero length packet idle mode.

For each channel, the MS shall perform at least  $N/A_{VG\_I}$  (rounded to the nearest integer) measurements of  $SS_{CH,n}$  before valid  $\gamma_{CH}$  values can be determined

During GPRS downlink TBF transfer, the MS shall measure the received signal quality as defined in clause 8.2. The reported value, RXQUAL, shall be the average within the reporting period. Only successfully decoded blocks intended for that MS shall be included in the average. Alternatively, if CS4 is used, the MS is allowed to report RXQUAL = 7. The first reporting period starts with and includes the first assignment message for the downlink transfer. The reporting period ends, and the subsequent reporting starts, no earlier than two blocks before the transmission of a quality report and no later than one block before the transmission of a quality report. In averaging, measurements made during previous reporting periods shall always be discarded.

During EGPRS downlink TBF transfer, the MS shall measure the received signal quality as defined in clause 8.2. The quality parameters shall be, for the radio blocks intended for this MS only (of which the right TFI could be decoded: see 3GPP TS 04.60), individually averaged per channel (timeslot) and per modulation type as follows:

$$R_n = (1 - e) \cdot R_{n-1} + e \cdot x_n, \quad R_{-1} = 0$$

$$\text{MEAN\_BEP\_TN}_n = (1 - e \cdot \frac{x_n}{R_n}) \cdot \text{MEAN\_BEP\_TN}_{n-1} + e \cdot \frac{x_n}{R_n} \cdot \text{MEAN\_BEP}_{\text{block},n}$$

$$\text{CV\_BEP\_TN}_n = (1 - e \cdot \frac{x_n}{R_n}) \cdot \text{CV\_BEP\_TN}_{n-1} + e \cdot \frac{x_n}{R_n} \cdot \text{CV\_BEP}_{\text{block},n}$$

Where:  $n$  is the iteration index, incremented per each downlink radio block.

$R_n$  denotes the reliability of the filtered quality parameters.

$e$  is the forgetting factor defined below.

$x_n$  denotes the existence of quality parameters for the  $n^{\text{th}}$  block, i.e. if the radio block is intended for this MS.  $x_n$  values 1 and 0 denote the existence and absence of quality parameters, respectively.

In case BEP\_PERIOD2 is received and with a field value different than 15,  $e$  shall be defined as  $e_2$  according to BEP\_PERIOD2 as shown in the table below. This allows for individual filtering per MS.

In case BEP\_PERIOD2 is received and with the field value 15 (norm),  $e$  shall be defined as  $e_1$  according to BEP\_PERIOD as shown in the table below. This allows for normal filtering (non-individual). This BEP\_PERIOD2 shall be used by the considered MS in the serving cell, until a new BEP\_PERIOD2 is received by this MS in the same cell, or the MS leaves the cell or the MS enters packet idle mode.

Field value	15	14	13	12	11	10	9	8	7	6	5	4	3	2	1	0
BEP_PERIOD	Reserved					25	20	15	12	10	7	5	4	3	2	1
$e_1$	-					0,08	0,1	0,15	0,2	0,25	0,3	0,4	0,5	0,65	0,8	1
BEP_PERIOD 2	Norm	90	70	55	40	25	20	15	12	10	7	5	4	3	2	1
$e_2$	$e_1$	0,03	0,04	0,05	0,065	0,08	0,1	0,15	0,2	0,25	0,3	0,4	0,5	0,65	0,8	1

BEP\_PERIOD2 is sent to individual MS on PACCH D/L. See 3GPP TS 04.60.

BEP\_PERIOD is broadcast on PBCCH or, if PBCCH does not exist, on BCCH.

An MS shall report the overall MEAN\_BEP, and CV\_BEP per modulation type averaged over all allocated channels (timeslots) as follows:

$$\text{MEAN\_BEP}_n = \frac{\sum_j R_n^{(j)} \cdot \text{MEAN\_BEP\_TN}_n^{(j)}}{\sum_j R_n^{(j)}}$$

$$\text{CV\_BEP}_n = \frac{\sum_j R_n^{(j)} \cdot \text{CV\_BEP\_TN}_n^{(j)}}{\sum_j R_n^{(j)}}$$

where  $n$  = the iteration index at reporting time

$j$  = the channel number.

When entering packet transfer mode and/or when selecting a new cell, the filters shall reset the values of  $n$  to 0. When a new timeslot is allocated for a downlink TBF, the filters shall reset the values of  $\text{MEAN\_BEP}_{n-1}$ ,  $\text{CV\_BEP}_{n-1}$  and  $R_{n-1}$  to 0 for this timeslot.

The MS shall transfer the 8  $\gamma_{CH}$  values and the RXQUAL, C and SIGN\_VAR values (see clause 10.2.3.1.2) to the network in the Channel Quality Report sent on PACCH. An MS using EGPRS shall instead of RXQUAL and SIGN\_VAR send MEAN\_BEP and CV\_BEP. The MS shall report MEAN\_BEP and CV\_BEP for the modulations, GMSK and/or 8-PSK (i.e. GMSK\_MEAN\_BEP, GMSK\_CV\_BEP; and/or 8PSK\_MEAN\_BEP, 8PSK\_CV\_BEP respectively), for which it has received blocks since it last sent a measurement report to the network. Additionally, the MS shall report per slot measurements (MEAN\_BEP\_TN<sub>x</sub>) according to what the network has ordered (see 3GPP TS 04.60). The reporting period ends no earlier than two blocks for a GPRS TBF mode and three blocks for an EGPRS TBF mode before the transmission of a quality report and no later than one block before the transmission of a quality report.

$N/A_{VG,I}$  is broadcast on PBCCH or, if PBCCH does not exist, on BCCH or CPBCCH.

---

## A.2 Functional requirement

The present algorithm is based on the following assumptions:

- single cell BSS;
- the necessity to make a handover according to radio criteria is recognized in the BSS. It can lead to either an (internal) intracell handover or an intercell handover;
- evaluation of a preferred list of target cells is performed in the BSS;
- cell allocation is done in the MSC;
- intracell handover for radio criteria (interference problems) may be performed directly by the BSS;
- the necessity to make a handover because of traffic reason (network directed handover) is recognized by the MSC and it is performed by sending a "handover candidate enquiry message" to BSS;
- the RF power control algorithm shall be implemented in order to optimize the RF power output from the MS (and BSS if power control is implemented) ensuring at the same time that the signal level received at the BSS (MS) is sufficient to keep adequate quality;
- all parameters controlling the handover and power control processes shall be administered on a cell-by-cell basis by means of O&M. The overall handover and power control process is split into the following stages:
  - i) BSS pre-processing and threshold comparisons;
  - ii) BSS decision algorithm;
  - iii) MSC cell allocation algorithm.

A BSS decision algorithm is specified such that the BSS can fulfil the mandatory requirement of being able to produce a preferred list of target cells for handover.

It should be noted that since measurement results can also be sent to the MSC in the "handover required" message, the handover decision algorithm may be implemented in either the MSC or the BSS.

---

## Annex H (normative): Modification to GSM 05.10

This annex details the modified clauses of GSM 05.10 which are applicable to TAPS.

All references to other GSM standards and specifications are to the standards as modified by the present document.

Where the following channel names appear in diagrams, they should be treated as if they had been deleted.

- CTSARCH
- CTSAGCH
- CTSBCH
- CTSPCH
- TCH/EF
- TCH/AFS
- TCH/AHS
- TCH/HS
- TCH/EFS
- TCH/AF
- TCH/AH
- TCH/FS
- E-TCH/F followed by a data rate
- TCH/F followed by a data rate
- TCH/H followed by a data rate
- HSCSD
- ECSD
- NCH

The following clauses have the same numbering as in GSM 05.10.

### 1.2 Definitions and abbreviations

In addition to those below, abbreviations used in the present document are listed in 3GPP TS 01.04.

For the purposes of the present document, the following terms and definitions apply:

**BTS:** Base Transceiver Station

**Timing Advance:** signal sent by the BTS to the MS which the MS uses to advance its timings of transmissions to the BTS so as to compensate for propagation delay

**Quarter symbol number:** timing of quarter symbol periods (12/13  $\mu$ s) within a timeslot. Symbol period can be 1 or 3 bit periods depending upon modulation

**Timeslot number:** timing of timeslots within a TDMA frame

**TDMA frame number:** count of TDMA frames relative to an arbitrary start point

**Current Serving BTS:** BTS on one of whose channels (TCH, DCCH, CCCH or PDCH) the MS is currently operating

**Timebase counters:** set of counters which determine the timing state of signals transmitted by a BTS or MS

**MS timing offset:** delay of the received signal relative to the expected signal from an MS at zero distance under static channel conditions with zero timing advance. This is accurate to  $\pm 1$  symbol, and reported once per SACCH or after a RACH as required (i.e. at the same rate as timing advance). For example, for an MS with a round trip propagation delay of P symbols, but with a timing advance of T symbols, the reported timing offset will be P-T quantized to the nearest symbol. For GPRS the MS timing offset is not reported

**Timing Advance Index:** Timing Advance Index TAI used for GPRS, which determines the position of the subchannel on PTCCCH (see 3GPP TS 05.02) used by the MS to send an access burst, from which the network can derive the timing advance

**Time group (TG):** used for compact, time groups shall be numbered from 0 to 3 and a particular time group shall be referred to by its time group number (TG) (see 3GPP TS 05.02)

## 2 General description of synchronization system

This clause gives a general description of the synchronization system. Detailed requirements are given in clauses 3 to 7.

The BTS sends signals on the BCCH or, for COMPACT on the CPBCCH, to enable the MS to synchronize itself to the BTS and if necessary correct its frequency standard to be in line with that of the BTS. The signals sent by the BTS for these purposes are:

- a) frequency correction bursts;
- b) synchronization bursts.

The timings of timeslots, TDMA frames, TCH frames, control channel frames, and (for COMPACT) the rotation of time groups are all related to a common set of counters which run continuously whether the MS and BTS are transmitting or not. Thus, once the MS has determined the correct setting of these counters, all its processes are synchronized to the current serving BTS.

The MS times its transmissions to the BTS in line with those received from the BTS. The BTS sends to each MS a "timing advance" parameter (TA) according to the perceived round trip propagation delay BTS-MS-BTS. The MS advances its timing by this amount, with the result that signals from different MS's arriving at the BTS and compensated for propagation delay. This process is called "adaptive frame alignment".

Additionally, synchronization functions may be implemented in both the MS and the BTS to support the so-called pseudo synchronization scheme. The support of this scheme is optional except that MS shall measure and report the Observed Timing Difference (OTD), which is a mandatory requirement. The detailed specifications of the pseudo-synchronization scheme are included in annex A.

### 3.1 Timing state of the signals

The timing state of the signals transmitted by a BTS, a MS, or an Compact BTS and MS is defined by the following counters:

- Quarter symbol number QN (0 - 624)- Symbol number BN (0 - 156);
- Timeslot number TN (0 - 7);
- TDMA frame number FN (0 to  $(26 \times 51 \times 2\ 048) - 1 = 2\ 715\ 647$ ); or
- for Compact, TDMA frame number FN (0 to  $(52 \times 51 \times 1\ 024) - 1 = 2\ 715\ 647$ ).



## 3.2 Relationship between counters

The relationship between these counters is as follows:

- QN increments every 12/13  $\mu$ s;
- BN = Integer part of QN/4;
- TN increments whenever QN changes from count 624 to 0;
- FN increments whenever TN changes from count 7 to 0.

## 4 Timing of transmitted signals

The timing of signals transmitted by the MS, and BTS are defined in 3GPP TS 05.02.

The MS can use the timing of receipt of the synchronization burst to set up its timebase counters as follows:

QN is set by the timing of the training sequence;

TN = 0 when the synch burst is received;

FN =  $51 \cdot ((T3 - T2) \bmod (26)) + T3 + 51 \times 26 \times T1$  when the synch burst is received (where  $T3 = (10 \times T3') + 1$ ,  $T1$ ,  $T2$  and  $T3'$  being contained in information fields in synchronization burst).

For Compact, the MS can use the timing of receipt of the synchronization burst to set up its timebase counters as follows:

QN is set by the timing of the training sequence;

FN =  $(R1 \times 51 + R2) \times 52 + 51$  when the synch burst is received (where R1 and R2 are contained in information fields in synchronization burst);

TN is determined from TG as described in 3GPP TS 05.02, where TG is contained in information fields in synchronization burst.

Thereafter, the timebase counters are incremented as in clause 3.2.

(When adjacent BTSs are being monitored for handover purposes, or for cell reselection purposes in group receive mode, the MS may choose to store the values of QN, TN and FN for all the BTSs whose synchronization bursts have been detected relative to QN, TN and FN for its current serving BTS.)

## 6 MS Requirements for Synchronization

The MS shall only start to transmit to the BTS if the requirements of clauses 6.1 to 6.4 are met.

The conditions under which the requirements of clauses 6.1 to 6.4 must be met shall be 3 dB below the reference sensitivity level or input level for reference performance, whichever applicable, in 3GPP TS 05.05 and 3 dB less carrier to interference ratio than the reference interference ratios in 3GPP TS 05.05.

In discontinuous reception (DRX), the MS should meet the requirements of clauses 6.1 to 6.3 during the times when the receiver is required to be active.

### 6.4 Timing of transmission

The MS shall time its transmissions to the BTS according to signals received from the BTS. The MS transmissions to the BTS, measured at the MS antenna, shall be 468,75-TA symbol periods (i.e. 3 timeslots-TA) behind the transmissions received from the BTS, where TA is the last timing advance received from the current serving BTS. The tolerance on these timings shall be  $\pm 1$  symbol period.

In case of a multislot configuration, the MS shall use a common timebase for transmission of all channels. In this case, the MS may optionally use a timeslot length of 157 symbol periods on timeslots  $TN = 0$  and 4, and 156 symbol periods on timeslots with  $TN = 1, 2, 3, 5, 6$  and 7, rather than 156,25 symbol periods on all timeslots. In case of a packet switched multislot configuration the common timebase shall be derived from all timeslots monitored by the MS. In this case, the MS may assume that the BTS uses a timeslot length of 156,25 symbol periods on all timeslots.

## Annex I (normative): Modification to 3GPP TS 24.008

This annex details the modified clauses of 3GPP TS 24.008 which are applicable to TAPS.

All references to other GSM standards and specifications are to the standards as modified by the present document.

The following clauses have the same numbering as in 3GPP TS 24.008.

### 1.2 Application to the interface structures

The procedures defined in the present document apply to the interface structures defined in GSM 04.03. They use the functions and services provided by lower layer defined in EN 300 937 and EN 300 938. 3GPP TS 24.007 gives the general description of layer 3 (A/Gb mode) including procedures, messages format and error handling.

### 1.5 Use of logical channels in A/Gb mode

The logical control channels are defined in GSM 05.02. In the following those control channels are considered which carry signalling information or specific types of user packet information:

- i) Broadcast Control CHannel (BCCH): downlink only, used to broadcast Cell specific information;
- ii) Synchronization CHannel (SCH): downlink only, used to broadcast synchronization and BSS identification information;
- iii) Paging CHannel (PCH): downlink only, used to send page requests to Mobile Stations (MSs);
- iv) Random Access CHannel (RACH): uplink only, used to request a Dedicated Control CHannel;
- v) Access Grant CHannel (AGCH): downlink only, used to allocate a Dedicated Control CHannel;
- vi) Standalone Dedicated Control CHannel (SDCCH): bi-directional;
- vii) Fast Associated Control CHannel (FACCH): bi-directional, associated with a Traffic CHannel;
- viii) Slow Associated Control CHannel (SACCH): bi-directional, associated with a SDCCH or a Traffic CHannel;
- ix) Cell Broadcast CHannel (CBCH): downlink only used for general (not point to point) short message information.

Two service access points are defined on signalling layer 2 which are discriminated by their Service Access Point Identifiers (SAPI) (see EN 300 938):

- i) SAPI 0: supports the transfer of signalling information including user-user information;
- ii) SAPI 3: supports the transfer of user short messages.

Layer 3 selects the service access point, the logical control channel and the mode of operation of layer 2 (acknowledged, unacknowledged or random access, see EN 300 937 and EN 300 938) as required for each individual message.

#### 1.6.1 List of procedures

The following procedures are specified in the present document:

- a) Clause 4 specifies elementary procedures for Mobility Management
  - mobility management common procedures (clause 4.3)
    - TMSI reallocation procedure (clause 4.3.1)
    - authentication procedure (clause 4.3.2)

- identification procedure (clause 4.3.3)
  - IMSI detach procedure (clause 4.3.4)
  - abort procedure (clause 4.3.5)
  - MM information procedure (clause 4.3.6)
  - mobility management specific procedures (clause 4.4)
    - location updating procedure (clause 4.4.1)
    - periodic updating (clause 4.4.2)
    - IMSI attach procedure (clause 4.4.3)
    - generic location updating procedure (clause 4.4)
  - connection management sublayer service provision
    - mobility management connection establishment (clause 4.5.1)
    - mobility management connection information transfer phase (clause 4.5.2)
    - mobility management connection release (clause 4.5.3)
  - GPRS specific mobility management procedures (clause 4.7)
    - GPRS attach procedure (clause 4.7.3)
    - GPRS detach procedure (clause 4.7.4)
    - GPRS routing area updating procedure (clause 4.7.5)
  - GPRS common mobility management procedures (clause 4.7)
    - GPRS P-TMSI reallocation procedure (clause 4.7.6)
    - GPRS authentication and ciphering procedure (clause 4.7.7)
    - GPRS identification procedure (clause 4.7.8)
    - GPRS information procedure (clause 4.7.12)
- d) Clause 6 specifies elementary procedures for session management
- GPRS session management procedures (clause 6.1)
    - PDP context activation (clause 6.1.1)
    - PDP context modification (clause 6.1.2)
    - PDP context deactivation (clause 6.1.3)

The elementary procedures can be combined to form structured procedures. Examples of such structured procedures are given in clause 7. This part of the Technical Specification is only provided for guidance to assist implementations.

Clause 8 specifies actions to be taken on various error conditions and also provides rules to ensure compatibility with future enhancements of the protocol.

### 1.7.2.1 Packet services in GSM (GSM only)

The MS operation mode C applies for the present document.

## 2.2.2 Vocabulary

The following terms are used in the present document:

- A **GSM security context** is established and stored in the MS and the network as a result of a successful execution of a GSM authentication challenge. The GSM security context consists of the GSM ciphering key and the ciphering key sequence number.
- **idle mode**: In this mode, the mobile station is not allocated any dedicated channel; it listens to the CCCH and the BCCH.
- **dedicated mode**: In this mode, the mobile station is allocated at least two dedicated channels, only one of them being a SACCH.
- **packet idle mode**: (only applicable for mobile stations supporting GPRS) In this mode, mobile station is not allocated any radio resource on a packet data physical channel; it listens to the PBCCH and PCCCH or, if those are not provided by the network, to the BCCH and the CCCH, see GSM 04.60.
- **packet transfer mode**: (only applicable for mobile stations supporting GPRS) In this mode, the mobile station is allocated radio resource on one or more packet data physical channels for the transfer of LLC PDUs.
- **main DCCH**: In Dedicated mode, only two channels are used as DCCH, one being a SACCH, the other being a SDCCH or a FACCH; the SDCCH or FACCH is called here "the main DCCH".
- A channel is **activated** if it can be used for transmission, in particular for signalling, at least with UI frames. On the SACCH, whenever activated, it must be ensured that a contiguous stream of layer 2 frames is sent.
- A TCH is **connected** if circuit mode user data can be transferred. A TCH cannot be connected if it is not activated. A TCH which is activated but not connected is used only for signalling, i.e. as a DCCH.
- The data link of SAPI 0 on the main DCCH is called the **main signalling link**. Any message specified to be sent on the main signalling link is sent in acknowledged mode except when otherwise specified.
- The term "**to establish**" a link is a short form for "**to establish the multiframe mode**" on that data link. It is possible to send UI frames on a data link even if it is not established as soon as the corresponding channel is activated. Except when otherwise indicated, a data link layer establishment is done without an information field.
- A **temporary block flow** (TBF) is a physical connection used by the two RR peer entities to support the uni-directional transfer of LLC PDUs on packet data physical channels, see GSM 04.60.
- **RLC/MAC block**: A RLC/MAC block is the protocol data unit exchanged between RLC/MAC entities, see GSM 04.60.
- A **GMM context** is established when a GPRS attach procedure is successfully completed.
- **Network operation mode**: The three different network operation modes I, II, and III are defined in 3GPP TS 23.060.

The network operation mode shall be indicated as system information. For proper operation, the network operation mode should be the same in each cell of one routing area.

- **GPRS MS operation mode**: The three different GPRS MS operation modes A, B, and C are defined in 3GPP TS 23.060.
- **RR connection**: A RR connection is a dedicated physical circuit switched domain connection used by the two RR or RRC peer entities to support the upper layers' exchange of information flows.
- **GPRS**: Packet Services for GSM and UMTS system.
- The label (**GSM only**) indicates this clause or paragraph applies only to GSM system. For multi system case this is determined by the current serving radio access network.
- **In GSM,...** Indicates this paragraph applies only to GSM System. For multi system case this is determined by the current serving radio access network.

- **SIM**, Subscriber Identity Module (see 3GPP TS 02.17). This specification makes no distinction between SIM and USIM.
- **MS**: Mobile Station. This specification makes no distinction between MS and UE.
- **Cell Notification** is an (optimized) variant of the Cell Update Procedure which uses the LLC NULL frame for cell change notification which does not trigger the restart of the READY timer.

## 4.1 General

This clause describes the procedures used for mobility management for non-GPRS services and for GPRS-services at the radio interface (Reference Point Um and Uu).

The main function of the Mobility Management sublayer is to support the mobility of user terminals, such as informing the network of its present location and providing user identity confidentiality.

A further function of the MM sublayer is to provide connection management services to the different entities of the upper Connection Management (CM) sublayer (see 3GPP TS 24.007).

There are two sets of procedures defined in this chapter:

- MM procedures for non-GPRS services (performed by the MM entity of the MM sublayer); and
- GMM procedures for GPRS services (performed by the GMM entity of the MM sublayer), see 3GPP TS 24.007.

All the MM procedures described in this clause can only be performed if a RR connection has been established between the MS and the network. Else, the MM sublayer has to initiate the establishment of a RR connection (see GSM 04.18 clause 3.3).

In A/Gb mode, the GMM procedures described in this clause, use services provided by the RR sublayer without prior RR connection establishment.

GMM procedures are mandatory and applicable only for GPRS MSs and networks supporting those MSs.

### 4.1.1.1 Types of MM and GMM procedures

Depending on how they can be initiated, three types of MM procedures can be distinguished:

#### 1) MM common procedures:

A MM common procedure can always be initiated whilst a RR connection exists. The procedures belonging to this type are:

Initiated by the network:

- TMSI reallocation procedure;
- authentication procedure;
- identification procedure;
- MM information procedure;
- abort procedure.

However, abort procedure is used only if an MM connection is being established or has already been established i.e. not during MM specific procedures or during IMSI detach procedure, see clause 4.3.5.

Initiated by the mobile station:

- IMSI detach procedure (with the exceptions specified in clause 4.3.4).

## ii) MM specific procedures:

A MM specific procedure can only be initiated if no other MM specific procedure is running or no MM connection exists. The procedures belonging to this type are:

- normal location updating procedure;
- periodic updating procedure;
- IMSI attach procedure.

## iii) MM connection management procedures:

These procedures are used to establish, maintain and release a MM connection between the mobile station and the network, over which an entity of the upper CM layer can exchange information with its peer. A MM connection establishment can only be performed if no MM specific procedure is running. More than one MM connection may be active at the same time.

Depending on how they can be initiated, two types of GMM procedures can be distinguished:

## i) GMM common procedures:

The procedures belonging to this type are:

Initiated by the network when a GMM context has been established:

- P-TMSI (re-) allocation;
- GPRS authentication and ciphering;
- GPRS identification;
- GPRS information.

## ii) GMM specific procedures:

Initiated by the network and used to detach the IMSI in the network for GPRS services and/or non-GPRS services and to release a GMM context:

- GPRS detach.

Initiated by the MS and used to attach or detach the IMSI in the network for GPRS services and/or non-GPRS services and to establish or release a GMM context:

- GPRS attach;
- GPRS detach.

Initiated by the MS when a GMM context has been established:

- normal routing area updating;
- periodic routing area updating.

#### 4.1.2.1 MM sublayer states in the mobile station

In this clause, the possible states for the MM sublayer in the mobile station is described. In figure 4.1/3GPP TS 24.008 an overview of the MM sublayer protocol is given. Where the following states appear in diagrams, they should be treated as if they had been deleted.

##### Main states

21. MM CONNECTION ACTIVE (GROUP TRANSMIT MODE)
22. WAIT FOR RR CONNECTION (GROUP TRANSMIT MODE)
23. LOCATION UPDATING PENDING

## 24. IMSI DETACH PENDING

Substates of the MM IDLE state

## 19.3 LIMITED SERVICE

## 19.9 RECEIVING GROUP CALL (NORMAL SERVICE)

## 19.10 RECEIVING GROUP CALL (LIMITED SERVICE)

MM sublayer states on the network side

## 10. WAIT OF A GROUP CALL

## 11. GROUP CALL ACTIVE

## 12. MM CONNECTION ACTIVE (GROUP CALL)

## 13. WAIT FOR BROADCAST CALL

## 14. BROADCAST CALL ACTIVE

## 4.1.2.1.1 Main states

## 0 NULL

The mobile station is inactive (e.g. power down). Important parameters are stored. Only manual action by the user may transfer the MM sublayer to another state.

## 3 LOCATION UPDATING INITIATED

A location updating procedure has been started and the MM awaits a response from the network. The timer T3210 is running.

## 5 WAIT FOR OUTGOING MM CONNECTION

The MM connection establishment has been started, and the MM awaits a response from the network. The timer T3230 is running.

## 6 MM CONNECTION ACTIVE

The MM sublayer has a RR connection to its peer entity on the network side. One or more MM connections are active.

## 7 IMSI DETACH INITIATED

The IMSI detach procedure has been started. The timer T3220 is running.

## 8 PROCESS CM SERVICE PROMPT

The MM sublayer has a RR connection to its peer entity on the network side. The Mobile Station has received a CM SERVICE PROMPT message but has not yet responded \$(CCBS)\$.

## 9 WAIT FOR NETWORK COMMAND

The MM sublayer has a RR connection to its peer entity in the network, but no MM connection is established. The mobile station is passive, awaiting further commands from the network. The timer T3240 may be running.

## 10 LOCATION UPDATE REJECTED

A location updating procedure has been rejected and RR connection release is awaited. The timer T3240 is running.



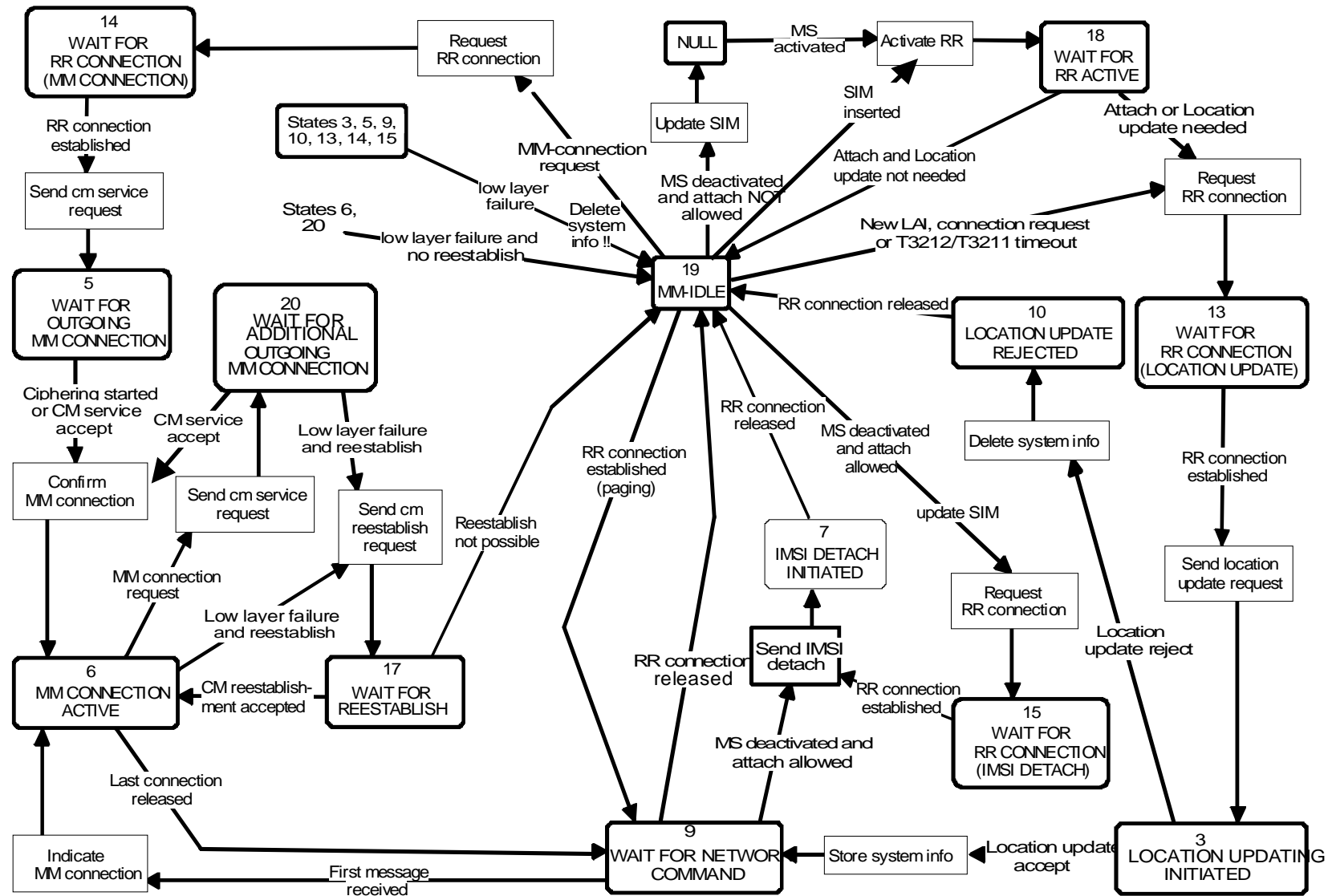
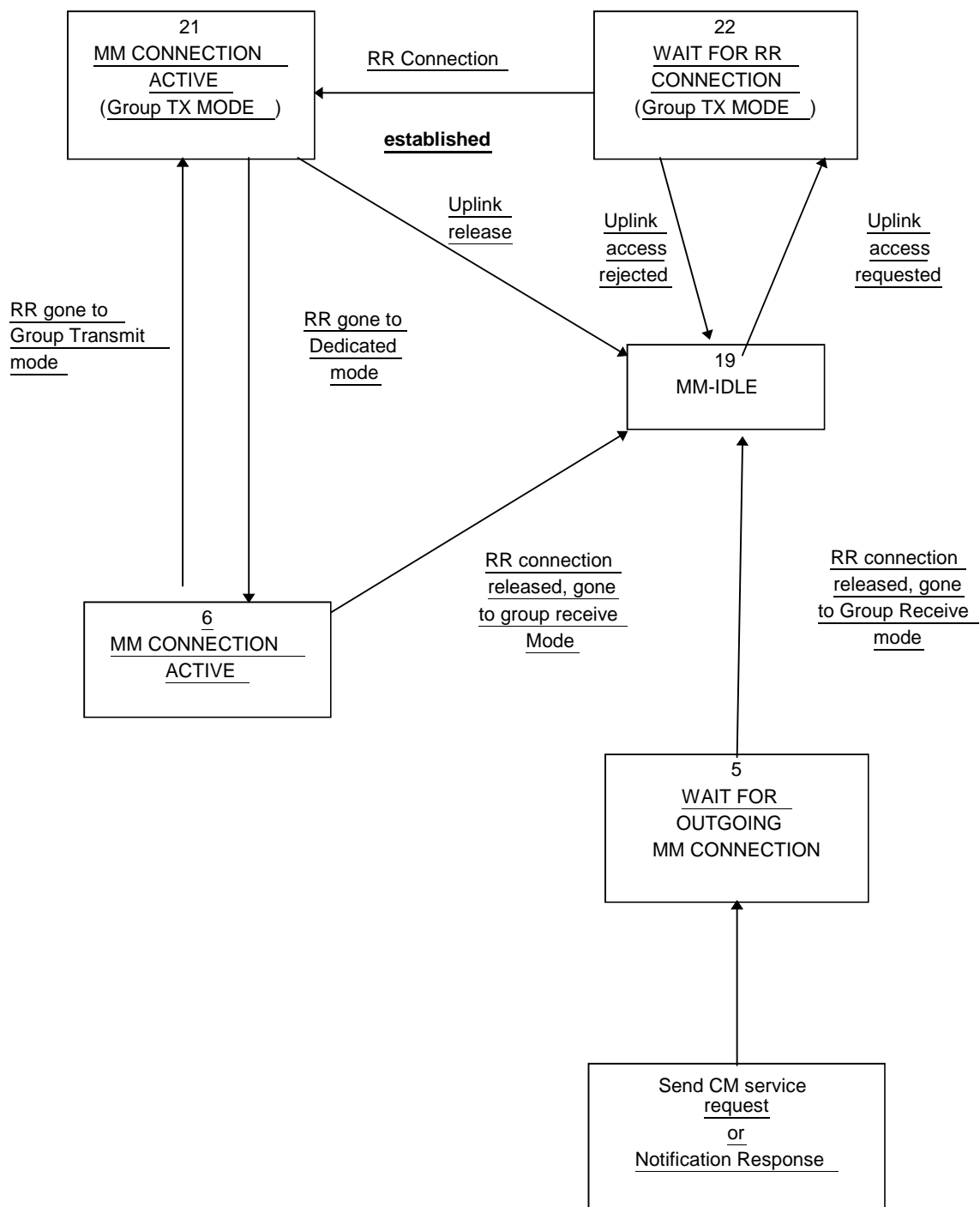

Figure 4.1a/3GPP TS 24.008: Overview mobility management protocol/MS Side



### Additions to figure 4.1.a/3GPP TS 24.008

#### 13 WAIT FOR RR CONNECTION (LOCATION UPDATING)

The MM sublayer has requested RR connection establishment for starting the location updating procedure.

#### 14 WAIT FOR RR CONNECTION (MM CONNECTION)

The MM sublayer has requested RR connection establishment for dedicated mode for starting the MM connection establishment.

#### 15 WAIT FOR RR CONNECTION (IMSI DETACH)

The MM sublayer has requested RR connection establishment for starting the IMSI detach procedure.

#### 17 WAIT FOR REESTABLISH

A lower layer failure has occurred and re-establishment may be performed from the disturbed CM layer entities.

#### 18 WAIT FOR RR ACTIVE

The MM sublayer has requested activation of the RR sublayer.

#### 19 MM IDLE

There is no MM procedure running and no RR connection exists. This is a compound state, and the actual behaviour of the mobile station to Connection Management requests is determined by the actual substate as described hereafter.

#### 20 WAIT FOR ADDITION/AL OUTGOING MM CONNECTION.

The MM connection establishment for an additional MM connection has been started, and the MM awaits response from the network.

### 4.1.2.1.2 Substates of the MM IDLE state

For the description of the behaviour of the MS the MM IDLE state is subdivided in several substates, also called the service states. The service state pertains to the whole MS (ME alone if no SIM is inserted, or ME plus SIM.). The service state depends on the update status (see 4.1.2.2) and on the selected cell.

#### 19.1 NORMAL SERVICE

Valid subscriber data are available, update status is U1, a cell is selected that belongs to the LA where the subscriber is registered.

In this state, all requests from the CM layers are treated normally.

#### 19.2 ATTEMPTING TO UPDATE

Valid subscriber data are available, update status is U2 and a cell is selected. Requests from upper layers are accepted. The request triggers first a location updating attempt in the selected cell, and then triggers the needed procedure only in case of successful location updating, otherwise the request is rejected.

#### 19.3 LIMITED SERVICE

Valid subscriber data are available, update status is U3, and a cell is selected, which is known not to be able to provide normal service. No services are offered.

#### 19.4 NO IMSI

No valid subscriber data (no SIM, or the SIM is not considered valid by the ME), and a cell is selected. No services are offered.

#### 19.5 NO CELL AVAILABLE

No cell can be selected. This state is entered after a first intensive search failed (state 19.7). Cells are searched at a low rhythm. No services are offered.

#### 19.6 LOCATION UPDATE NEEDED

Valid subscriber data are available, and for some reason a location updating must be done as soon as possible (for instance update status is U1 but the selected cell is not in the registered LA, or the timer has expired, ...). This state is usually of no duration, but can last, e.g. in the case of access class blocking.

#### 19.7 PLMN SEARCH

The mobile station is searching for PLMNs, and the conditions for state 19.8 are not met. This state is ended when either a cell is selected (the new state is 19.1, 19.3 or 19.6), or when it is concluded that no cell is available for the moment (the new state is 19.5).

## 19.8 PLMN SEARCH, NORMAL SERVICE

Valid subscriber data are available, update status is U1, a cell is selected which belongs to the LA where the subscriber is registered, and the mobile station is searching for PLMNs. This state is ended when either a cell is selected (the new state is 19.1, 19.3 or 19.6), or when it is concluded that no cell is available for the moment (the new state is 19.5).

### 4.1.2.2 The update Status

In parallel with the sublayer states described in clause 4.1.2.1 and which control the MM sublayer protocol, an update status exists.

The update status pertains to a specific subscriber embodied by a SIM. This status is defined even when the subscriber is not activated (SIM removed or connected to a switched-off ME). It is stored in a non-volatile memory in the SIM. The update status is changed only as a result of a location updating procedure attempt (with the exception of an authentication failure and of some cases of CM service rejection). In some cases, the update status is changed as a result of a GPRS attach, GPRS routing area update, service request or network initiated GPRS detach procedure.

#### U1 UPDATED

The last location updating attempt was successful (correct procedure outcome, and the answer was acceptance from the network). With this status, the SIM contains also the LAI of the LA where the subscriber is registered, and possibly valid TMSI, GSM ciphering key. The "Location update status" stored on the SIM shall be "updated".

#### U2 NOT UPDATED

The last location updating attempt made failed procedurally (no significant answer was received from the network, including the cases of failures or congestion inside the network).

For this status, the SIM does not contain any valid LAI, TMSI, GSM ciphering key. For compatibility reasons, all these fields must be set to the "deleted" value at the moment the status is set to NOT UPDATED. However the presence of other values shall not be considered an error by the mobile station. The "Location update status" stored on the SIM shall be "not updated".

#### U3 ROAMING NOT ALLOWED

The last location updating attempt run correctly, but the answer from the network was negative (because of roaming or subscription restrictions).

For this status, the SIM does not contain any valid LAI, TMSI, GSM ciphering key. For compatibility reasons, all these fields must be set to the "deleted" value at the moment the status is set to ROAMING NOT ALLOWED. However the presence of other values shall not be considered an error by the mobile station. The "Location update status" stored on the SIM shall be "Location Area not allowed".

### 4.1.2.3 MM sublayer states on the network side

#### 1 IDLE

The MM sublayer is not active.

#### 2 WAIT FOR RR CONNECTION

The MM sublayer has received a request for MM connection establishment from the CM layer. A RR connection to the mobile station is requested from the RR sublayer (i.e. paging is performed).

#### 3 MM CONNECTION ACTIVE

The MM sublayer has a RR connection to a mobile station. One or more MM connections are active.

#### 4 IDENTIFICATION INITIATED

The identification procedure has been started by the network. The timer T3270 is running.

#### 5 AUTHENTICATION INITIATED

The authentication procedure has been started by the network. The timer T3260 is running.

#### 6 TMSI REALLOCATION INITIATED

The TMSI reallocation procedure has been started by the network. The timer T3250 is running.

#### 7 SECURITY MODE INITIATED

In GSM, the cipher mode setting procedure has been requested to the RR sublayer.

#### 8a WAIT FOR MOBILE ORIGIN/ATED MM CONNECTION

A CM SERVICE REQUEST message is received and processed, and the MM sublayer awaits the "opening message" of the MM connection.

#### 8b WAIT FOR NETWORK ORIGIN/ATED MM CONNECTION

A CM SERVICE PROMPT message has been sent by the network and the MM sublayer awaits the "opening message" of the MM connection \$(CCBS)\$.

#### 9 WAIT FOR REESTABLISHMENT

The RR connection to a mobile station with one or more active MM connection has been lost. The network awaits a possible re-establishment request from the mobile station.

### 4.1.3.1 GMM states in the MS

In this clause, the possible GMM states are described of a GMM entity in the mobile station. Clause 4.1.3.1.1 summarizes the main states of a GMM entity, see figure 4.1b/3GPP TS 24.008. The substates that have been defined are described in clauses 4.1.3.1.2 and 4.1.3.1.3.

However, it should be noted that this clause does not include a description of the detailed behaviour of the MS in the single states and does not cover abnormal cases. Thus, figure 4.1b/3GPP TS 24.008 is rather intended to give an overview of the state transitions than to be a complete state transition diagram. A detailed description of the behaviour of the MS is given in clause 4.2. Especially, with respect to the behaviour of the MS in abnormal cases it is referred to clause 4.7. Where the following states appear in diagrams, they should be treated as if they had been deleted.

- GMM-SERVICE-REQUEST-INITIATED (UMTS only)
- GMM-REGISTERED.ATTEMPTING-TO-UPDATE-MM
- GMM-REGISTERED.IMSI-DETACH-INITIATED

#### 4.1.3.1.1.2 GMM-DEREGISTERED

The GPRS capability has been enabled in the MS, but no GMM context has been established. In this state, the MS may establish a GMM context by starting the GPRS attach procedure.

#### 4.1.3.1.1.3 GMM-REGISTERED-INITIATED

A GPRS attach procedure has been started and the MS is awaiting a response from the network.

#### 4.1.3.1.1.4 GMM-REGISTERED

A GMM context has been established, i.e. the GPRS attach procedure has been successfully performed. In this state, the MS may activate PDP contexts, may send and receive user data and signalling information and may reply to a page request. Furthermore, cell and routing area updating are performed.

#### 4.1.3.1.1.5 GMM-DEREGISTERED-INITIATED

The MS has requested release of the GMM context by starting the GPRS detach procedure. This state is only entered if the MS is not being switched off at detach request.

### 4.1.3.2 GPRS update status

In addition to the GMM sublayer states described so far, a GPRS update status exists.

The GPRS update status pertains to a specific subscriber embodied by a SIM. This status is defined even when the subscriber is not activated (SIM removed or connected to a switched off ME). It is stored in a non-volatile memory in the SIM. The GPRS update status is changed only after execution of a GPRS attach, network initiated GPRS detach, authentication procedure, or routing area updating procedure.

#### GU1: UPDATED

The last GPRS attach or routing area updating attempt was successful (correct procedure outcome, and the answer was accepted by the network). The SIM contains the RAI of the routing area (RA) to which the subscriber was attached, and possibly a valid P-TMSI, GPRS GSM ciphering key and GPRS ciphering key sequence number.

#### GU2: NOT UPDATED

The last GPRS attach or routing area updating attempt failed procedurally, i.e. no response was received from the network. This includes the cases of failures or congestion inside the network.

In this case, the SIM may contain the RAI of the routing area (RA) to which the subscriber was attached, and possibly also a valid P-TMSI, GPRS GSM ciphering key and GPRS ciphering key sequence number. For compatibility reasons, all these fields shall be set to the "deleted" value if the RAI is deleted. However, the presence of other values shall not be considered an error by the MS.

#### GU3: ROAMING NOT ALLOWED

The last GPRS attach or routing area updating attempt was correctly performed, but the answer from the network was negative (because of roaming or subscription restrictions).

For this status, the SIM does not contain any valid RAI, P-TMSI, GPRS GSM ciphering key or GPRS ciphering key sequence number. For compatibility reasons, all these fields must be set to the value "deleted" at the moment the status is set to ROAMING NOT ALLOWED. However, the presence of other values shall not be considered an error by the MS.

#### 4.1.3.3.1.1 GMM-DEREGISTERED

The network has no GMM context or the GMM context is marked as detached, the MS is detached. In this state, the network may answer to a GPRS attach procedure initiated by the MS.

### 4.2.1.2 Other Cases

The state PLMN SEARCH is also entered in the following cases:

- in state NO IMSI, a SIM is inserted;
- in any state except NO IMSI, NO CELL AVAILABLE, NORMAL SERVICE after the user has asked for a PLMN selection;
- in any state except NO IMSI and NO CELL AVAILABLE, coverage is lost;
- roaming is denied;
- optionally, when the mobile station is in the ATTEMPTING TO UPDATE state and is in Automatic Network Selection mode and location update attempt counter is greater than or equal to 4.

The service state when the PLMN SEARCH is left depends on the outcome of the search and on the presence of the SIM as specified in clause 4.2.1.1.

## 4.2.2 Detailed Description of the MS behaviour in MM IDLE State.

In the MM IDLE state the mobile station shall behave according to the service state. In the following clauses the behaviour is described for the non-transient service states. It should be noted that after procedures in RR connected mode, e.g. location updating procedures, clause 4.2.3 applies which specifies the selection of the MM idle state. Furthermore when in sub-state NORMAL SERVICE, if a PLMN selection is requested, the MS enters sub-state SEARCH FOR PLMN, NORMAL SERVICE. Where the following states appear in diagrams, they should be treated as if they had been deleted.

- Service State, RECEIVING GROUP CALL (NORMAL SERVICE)
- Service State, RECEIVING GROUP CALL (LIMITED SERVICE)

### 4.2.2.1 Service State, NORMAL SERVICE

When in state MM IDLE and service state NORMAL SERVICE, the mobile station shall:

- perform normal location updating when a new location area is entered;
- perform location updating procedure at expiry of timer T3211 or T3213;
- perform periodic updating at expiration of timer T3212;
- perform IMSI detach;
- support requests from the CM layer;
- respond to paging.

### 4.2.2.2 Service State, ATTEMPTING TO UPDATE

When in state MM IDLE and service state ATTEMPTING TO UPDATE the mobile station shall:

- perform location updating procedure at expiry of timer T3211 or T3213;
- perform normal location updating when the location area identification of the serving cell changes;
- if entry into this state was caused by c) or d) or f) (with cause different from "abnormal release, unspecified") or g) (with cause "retry upon entry into a new cell") of clause 4.4.4.9, then location updating shall be performed when a new cell is entered;
- if entry into this state was caused by e) or f) (with cause "abnormal release, unspecified") or g) (with cause different from "retry upon entry into a new cell") of clause 4.4.4.9, then location updating shall not be performed because a new cell is entered;
- perform normal location updating at expiry of timer T3212;
- not perform IMSI detach;
- use other request from CM layer as triggering of normal location updating procedure (if the location updating procedure is successful, then the request for MM connection is accepted, see clause 4.5.1);
- respond to paging (with IMSI).

### 4.2.2.3 Service State, LIMITED SERVICE

When in state MM IDLE and service state LIMITED SERVICE the mobile station shall:

- not perform periodic updating;
- not perform IMSI detach;
- reject any requests from CM entities for MM connections;

- perform normal location updating when a cell is entered which may provide normal service (e.g. location area not in one of the forbidden LAI lists.);
- it may respond to paging (with IMSI).

#### 4.2.2.4 Service State, NO IMSI

When in state MM IDLE and service state NO IMSI the mobile station shall (see clause 3.2, 3GPP TS 03.22 and GSM 05.08):

- not start any normal location updating attempt;
- not perform periodic updating;
- not perform IMSI detach if powered down;
- reject any request from CM entities for MM connections;
- not respond to paging;
- only perform default cell selection.

#### 4.2.2.5 Service State, SEARCH FOR PLMN, NORMAL SERVICE

When in state MM IDLE and service state SEARCH FOR PLMN, NORMAL SERVICE the mobile station shall:

- if timer T3211 or T3213 expires in this state perform a location updating procedure at the latest if and when back to NORMAL SERVICE state and if the cell is not changed;
- if timer T3212 expires in this state perform a periodic location updating procedure at the latest if and when back to NORMAL SERVICE state;
- perform IMSI detach;
- support requests from the CM layer;
- listen as far as possible to paging, and respond.

#### 4.2.2.6 Service State, SEARCH FOR PLMN

When in state MM IDLE and service state SEARCH FOR PLMN the mobile station shall:

- not start any normal location updating attempt;
- not perform periodic updating;
- not perform IMSI detach if powered down;
- reject any request from CM entities for MM connections;
- not respond to paging.

### 4.2.3 Service state when back to state MM IDLE from another state

When returning to MM IDLE, e.g. after a location updating procedure, the mobile station selects the cell as specified in 3GPP TS 03.22. With one exception, this is a normal cell selection.

If this return to idle state is not subsequent to a location updating procedure terminated with reception of cause "Roaming not allowed in this location area" the service state depends on the result of the cell selection procedure, on the update status of the mobile station, on the location data stored in the mobile station and on the presence of the SIM:

- if no cell has been found, the state is NO CELL AVAILABLE, until a cell is found;
- if no SIM is present, or if the inserted SIM is considered invalid by the MS, the state is NO IMSI;



- if the selected cell is in the location area where the MS is registered, then the state is NORMAL SERVICE; it shall be noted that this also includes an abnormal case described in clause 4.4.4.9;
- if the selected cell is in a location area where the mobile station is not registered but in which the MS is allowed to attempt a location update, then the state is LOCATION UPDATE NEEDED;
- if the selected cell is in a location area where the mobile station is not allowed to attempt a location update, then the state is LIMITED SERVICE;
- after some abnormal cases occurring during an unsuccessful location updating procedure, as described in clause 4.4.4.9, the state is ATTEMPTING TO UPDATE.

In case of a return from a location updating procedure to which was answered "Roaming not allowed in this location area", the service state PLMN SEARCH is entered as specified in clause 4.2.1.2.

## 4.2.4 Behaviour in state GMM-DEREGISTERED

The state GMM-DEREGISTERED is entered when:

- the MS is switched on;
- the GPRS capability has been enabled in the MS;
- a GPRS detach procedure has been performed; or
- a GMM procedure has failed (except routing area updating, see clause 4.7.5).

The selection of the appropriate substate of GMM-DEREGISTERED after switching on is described in clause 4.2.4.1. The specific behaviour of the MS in state GMM-DEREGISTERED is described in clause 4.2.4.2. The substate chosen when the GMM-DEREGISTERED state is returned to from another state except state GMM-NULL is described in clause 4.2.4.3.

It should be noted that transitions between the various substates of GMM-DEREGISTERED are caused by (e.g.):

- insertion or removal of the SIM;
- cell selection/reselection (see also 3GPP TS 03.22);
- PLMN search;
- loss/regain of coverage; or
- change of RA.

How various GMM procedures affect the GMM-DEREGISTERED substates and the GPRS update status is described in the detailed description of the GMM procedures in clause 4.7.

### 4.2.4.1.1 Selection of the substate after power on or enabling the MS's GPRS capability

When the MS is switched on, the substate shall be PLMN-SEARCH in case the SIM is inserted and valid. See GSM 05.08 for further details.

When the GPRS capability in an activated MS has been enabled, the selection of the GMM-DEREGISTERED substate depends on the MM state and the GPRS update status.

The substate chosen after PLMN-SEARCH, in case of power on or after enabling of the GPRS capability is:

- if the cell is not supporting GPRS, the substate shall be NO-CELL-AVAILABLE;
- if no SIM is present the substate shall be NO-IMSI;
- if a cell supporting GPRS has been found and the PLMN or LA is not in the forbidden list, then the substate shall be NORMAL-SERVICE;
- if the selected cell supporting GPRS is in a forbidden PLMN or a forbidden LA, then the MS shall enter the substate LIMITED-SERVICE;

- if the MS is in manual network selection mode and no cell supporting GPRS of the selected PLMN has been found, the MS shall enter the substate NO-CELL-AVAILABLE.

#### 4.2.4.2.2 Substate, ATTEMPTING-TO-ATTACH

The MS shall:

- perform GPRS attach on the expiry of timers T3311 or T3302;
- perform GPRS attach when the routing area of the serving cell has changed and the location area this cell is belonging to is not in the list of forbidden LAs;
- if entry into this state was caused by b) or d) with cause "Retry upon entry into a new cell", of clause 4.7.3.1.5, GPRS attach shall be performed when a new cell is entered; and
- if entry into this state was caused by c) or d) with cause different from "Retry upon entry into a new cell" of clause 4.7.3.1.5, GPRS attach shall not be performed when a new cell is entered.

#### 4.2.4.3 Substate when back to state GMM-DEREGISTERED from another GMM state

When returning to state GMM-DEREGISTERED, the MS shall select a cell as specified in 3GPP TS 03.22.

The substate depends on the result of the cell selection procedure, the outcome of the previously performed GMM specific procedures, on the GPRS update status of the MS, on the location area data stored in the MS and on the presence of the SIM:

- if no cell has been found, the substate is NO-CELL-AVAILABLE, until a cell is found;
- if no SIM is present or if the inserted SIM is considered invalid by the MS, the substate shall be NO-IMSI;
- if the selected cell is in a location area where the MS is allowed to roam, the substate shall be NORMAL-SERVICE;
- if a GPRS attach shall be performed (e.g. network requested reattach), the substate shall be ATTEMPTING-TO-ATTACH;
- if the selected cell is in a location area where the MS is not allowed to roam, the state shall be LIMITED-SERVICE.

#### 4.2.5.1.1 Substate, NORMAL-SERVICE

The MS shall:

- perform cell selection/reselection according to 3GPP TS 03.22;
- perform normal and periodic routing area updating; and
- receive and transmit user data and signalling information.

GPRS MSs in operation mode C shall answer to paging requests.

#### 4.2.5.1.4 Substate, ATTEMPTING-TO-UPDATE

The MS:

- should not send any user data;
- shall perform routing area update on the expiry of timers T3311 or T3302;
- shall perform routing area update when the routing area of the serving cell has changed and the location area this cell is belonging to is not in the list of forbidden LAs;

- shall if entry into this state was caused by b) or d) with cause "Retry upon entry into a new cell", of clause 4.7.5.1.5, perform routing area updating when a new cell is entered; and
- shall if entry into this state was caused by c) or d) with cause different from "Retry upon entry into a new cell" of clause 4.7.5.1.5, not perform routing area updating when a new cell is entered.

#### 4.2.5.1.7 Substate, ATTEMPTING-TO-UPDATE-MM

The MS shall:

- perform cell selection/reselection according to 3GPP TS 03.22;
- receive and transmit user data and signalling information.

GPRS MSs in operation mode C shall answer to paging requests.

### 4.3.1 TMSI reallocation procedure

The purpose of the TMSI reallocation procedure is to provide identity confidentiality, i.e. to protect a user against being identified and located by an intruder (see GSM 02.09, 3GPP TS 03.20).

If the identity confidentiality service is applied for an IMSI, a Temporary Mobile Subscriber Identity (TMSI) is used for identification within the radio interface signalling procedures.

The structure of the TMSI is specified in 3GPP TS 23.003. The TMSI has significance only within a location area. Outside the location area it has to be combined with the Location Area Identifier (LAI) to provide for an unambiguous identity.

Usually the TMSI reallocation is performed at least at each change of a location area. (Such choices are left to the network operator).

The reallocation of a TMSI can be performed either by a unique procedure defined in this clause or implicitly by a location updating procedure using the TMSI. The implicit reallocation of a TMSI is described together with that procedure.

If a TMSI provided by a mobile station is unknown in the network e.g. due to a data base failure, the network may require the mobile station to provide its International Mobile Subscriber Identity (IMSI). In this case the identification procedure (see clause 4.3.3) should be used before the TMSI reallocation procedure may be initiated.

The TMSI reallocation can be initiated by the network at any time whilst a RR connection exists between the network and the mobile station.

NOTE 1: Usually the TMSI reallocation is performed in ciphered mode.

NOTE 2: Normally the TMSI reallocation will take place in conjunction with another procedure, e.g. at location updating or at call setup (see 3GPP TS 29.002).

#### 4.3.1.1 TMSI reallocation initiation by the network

The network initiates the TMSI reallocation procedure by sending a TMSI REALLOCATION COMMAND message to the mobile station and starts the timer T3250.

The TMSI REALLOCATION COMMAND message contains a new combination of TMSI and LAI allocated by the network or a LAI and the IMSI if the used TMSI shall be deleted. Usually the TMSI-REALLOCATION COMMAND message is sent to the mobile station using a RR connection in ciphered mode (see 3GPP TS 03.20).

#### 4.3.1.3 TMSI reallocation completion in the network.

Upon receipt of the TMSI REALLOCATION COMPLETE message, the network stops the timer T3250 and either considers the new TMSI as valid or, if an IMSI was sent to the mobile station, considers the old TMSI as deleted.

If the RR connection is no more needed, then the network will request the RR sublayer to release it (see GSM 04.18 clause 3.5).

## 4.3.2b Authentication Procedure used for a GSM authentication challenge

The purpose of the authentication procedure is twofold (see 3GPP TS 03.20):

- First to permit the network to check whether the identity provided by the mobile station is acceptable or not;
- Second to provide parameters enabling the mobile station to calculate a new GSM ciphering key.

The cases where the authentication procedure should be used are defined in GSM 02.09.

The authentication procedure is always initiated and controlled by the network. GSM authentication challenge shall be supported by a ME supporting GSM radio access.

A GSM security context is established in the MS and the network when a GSM authentication challenge is performed in GSM. After a successful GSM authentication, the GSM ciphering key and the ciphering key sequence number, are stored both in the network and the MS.

### 4.3.2.1 Authentication request by the network

The network initiates the authentication procedure by transferring an AUTHENTICATION REQUEST message across the radio interface and starts the timer T3260. The AUTHENTICATION REQUEST message contains the parameters necessary to calculate the response parameters (see 3GPP TS 03.20 (in case of GSM authentication challenge)). In a GSM authentication challenge, the AUTHENTICATION REQUEST message also contains the GSM ciphering key sequence number allocated to the key which may be computed from the given parameters.

### 4.3.2.2 Authentication response by the mobile station

The mobile station shall be ready to respond upon an AUTHENTICATION REQUEST message at any time whilst a RR connection exists. With exception of the cases described in clause 4.3.2.5.1, it shall process the challenge information and send back an AUTHENTICATION RESPONSE message to the network.

In a GSM authentication challenge, the new GSM ciphering key calculated from the challenge information shall overwrite the previous GSM ciphering key. The new GSM ciphering key shall be stored on the SIM together with the ciphering key sequence number.

The SIM will provide the mobile station with the authentication response, based upon the authentication challenge from the network. A GSM authentication challenge will result in the SIM passing a SRES to the ME.

### 4.3.2.3 Authentication processing in the network

Upon receipt of the AUTHENTICATION RESPONSE message, the network stops the timer T3260 and checks the validity of the response (see 3GPP TS 03.20 in case of a GSM authentication challenge).

Upon receipt of the AUTHENTICATION FAILURE message, the network stops the timer T3260. In Synch failure case, the core network may renegotiate with the HLR/AuC and provide the MS with new authentication parameters.

### 4.3.2.4 Ciphering key sequence number

The security parameters for authentication and ciphering are tied together in sets. In a GSM authentication challenge, from a challenge parameter RAND both the authentication response parameter SRES and the GSM ciphering key can be computed given the secret key associated to the IMSI

In order to allow start of ciphering on a RR connection without authentication, the ciphering key sequence numbers are introduced. The ciphering key sequence number is managed by the network in the way that the AUTHENTICATION REQUEST message contains the ciphering key sequence number allocated to the GSM ciphering key (in case of a GSM authentication challenge) which may be computed from the RAND parameter carried in that message.

The mobile station stores the ciphering key sequence number with the GSM ciphering key (in case of a GSM authentication challenge) and indicates to the network in the first message (LOCATION UPDATING REQUEST, CM SERVICE REQUEST, PAGING RESPONSE, CM RE-ESTABLISHMENT REQUEST) which ciphering key sequence number the stored GSM ciphering key (in case of a GSM authentication challenge).

When the deletion of the ciphering key sequence number is described this also means that the associated GSM ciphering key shall be considered as invalid (i.e. the established GSM security context is no longer valid).

In GSM, the network may choose to start ciphering with the stored GSM ciphering key (under the restrictions given in GSM 02.09) if the stored ciphering key sequence number and the one given from the mobile station are equal.

NOTE: In some specifications the term KSI (Key Set Identifier) might be used instead of the term ciphering key sequence number.

#### 4.3.2.5 Authentication not accepted by the network

If authentication fails, i.e. if the response is not valid, the network may distinguish between the two different ways of identification used by the mobile station:

- the TMSI was used;
- the IMSI was used.

If the TMSI has been used, the network may decide to initiate the identification procedure. If the IMSI given by the mobile station then differs from the one the network had associated with the TMSI, the authentication should be restarted with the correct parameters. If the IMSI provided by the MS is the expected one (i.e. authentication has really failed), the network should proceed as described below.

If the IMSI has been used, or the network decides not to try the identification procedure, an AUTHENTICATION REJECT message should be transferred to the mobile station.

After having sent this message, all MM connections in progress (if any) are released and the network should initiate the RR connection release procedure described in clause 3.5 of GSM 04.18.

Upon receipt of an AUTHENTICATION REJECT message, the mobile station shall set the update status in the SIM to U3 ROAMING NOT ALLOWED, delete from the SIM the stored TMSI, LAI and ciphering key sequence number. The SIM shall be considered as invalid until switching off or the SIM is removed.

If the AUTHENTICATION REJECT message is received in the state IMSI DETACH INITIATED the mobile station shall follow clause 4.3.4.3.

If the AUTHENTICATION REJECT message is received in any other state the mobile station shall abort any MM specific, MM connection establishment or call re-establishment procedure, stop any of the timers T3210 or T3230 (if running), release all MM connections (if any), start timer T3240 and enter the state WAIT FOR NETWORK COMMAND, expecting the release of the RR connection. If the RR connection is not released within a given time controlled by the timer T3240, the mobile station shall abort the RR connection. In both cases, either after a RR connection release triggered from the network side or after a RR connection abort requested by the MS-side, the MS enters state MM IDLE, substate NO IMSI. If the MS has a separate ongoing RR connection to a different core network node, it shall consider this separate connection as still being good.

#### 4.3.3.3 Abnormal cases

##### (a) RR connection failure:

Upon detection of a RR connection failure before the IDENTITY RESPONSE is received, the network shall release all MM connections (if any) and abort any ongoing MM specific procedure.

##### (b) Expiry of timer T3270:

The identification procedure is supervised by the network by the timer T3270. At expiry of the timer T3270 the network may release the RR connection. In this case, the network shall abort the identification procedure and any ongoing MM specific procedure, release all MM connections if any, and initiate the RR connection release procedure as described in GSM 04.18 clause 3.5.

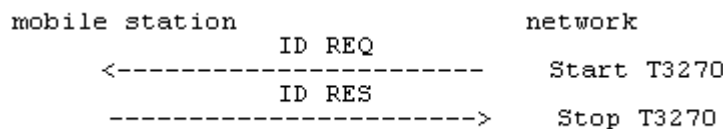

**Figure 4.3/3GPP TS 24.008: Identification sequence**

### 4.3.4 IMSI detach procedure

The IMSI detach procedure may be invoked by a mobile station if the mobile station is deactivated or if the Subscriber Identity Module (see GSM 02.17 and TS 131 102) is detached from the mobile station.

In GSM, a flag (ATT) broadcast in the L3-RR SYSTEM INFORMATION TYPE 3 message on the BCCH is used by the network to indicate whether the detach procedure is required. The value of the ATT flag to be taken into account shall be the one broadcast when the mobile station was in MM idle.

The procedure causes the mobile station to be indicated as inactive in the network.

#### 4.3.4.2 IMSI detach procedure in the network

When receiving an IMSI DETACH INDICATION message, the network may set an inactive indication for the IMSI. No response is returned to the mobile station. After reception of the IMSI DETACH INDICATION message the network shall release locally any ongoing MM connections, and start the normal RR connection release procedure (see GSM 04.18, clause 3.5).

### 4.4.1 Location updating procedure

The location updating procedure is a general procedure which is used for the following purposes:

- normal location updating (described in this clause);
- periodic updating (see clause 4.4.2);
- IMSI attach (see clause 4.4.3).

The normal location updating procedure is used to update the registration of the actual Location Area of a mobile station in the network. The location updating type information element in the LOCATION UPDATING REQUEST message shall indicate normal location updating. The conditions under which the normal location updating procedure is used by a mobile station in the MM IDLE state are defined for each service state in clause 4.2.2.

The normal location updating procedure shall also be started if the network indicates that the mobile station is unknown in the VLR as a response to MM connection establishment request.

To limit the number of location updating attempts made, where location updating is unsuccessful, an attempt counter is used. The attempt counter is reset when a mobile station is switched on or a SIM card is inserted.

Upon successful location updating the mobile station sets the update status to UPDATED in the SIM, and stores the received Location Area Identification in the SIM. The attempt counter shall be reset.

The detailed handling of the attempt counter is described in clauses 4.4.4.6 to 4.4.4.9.

The Mobile Equipment shall contain a list of "forbidden location areas for roaming", as well as a list of "forbidden location areas for regional provision of service". These lists shall be erased when the MS is switched off or when the SIM is removed, and periodically (with period in the range 12 to 24 hours). The location area identification received on the BCCH that triggered the location updating request shall be added to the suitable list whenever a location update reject message is received with the cause "Roaming not allowed in this location area" or with the cause "Location Area not allowed". The lists shall accommodate each 10 or more location area identifications. When the list is full and a new entry has to be inserted, the oldest entry shall be deleted.

The cell selection processes in the different states are described in 3GPP TS 03.22 and GSM 05.08.

The location updating procedure is always initiated by the mobile station.

## 4.4.2 Periodic updating

Periodic updating may be used to notify periodically the availability of the mobile station to the network. Periodic updating is performed by using the location updating procedure. The location updating type information element in the LOCATION UPDATING REQUEST message shall indicate periodic updating.

The procedure is controlled by the timer T3212 in the mobile station. If the timer is not already started, the timer is started each time the mobile station enters the MM IDLE substate NORMAL SERVICE or ATTEMPTING TO UPDATE. When the MS leaves the MM Idle State the timer T3212 shall continue running until explicitly stopped.

The timer is stopped (shall be set to its initial value for the next start) when:

- a LOCATION UPDATING ACCEPT or LOCATION UPDATING REJECT message is received;
- an AUTHENTICATION REJECT message is received;
- the first MM message is received, or security mode setting is completed in the case of MM connection establishment, except when the most recent service state is LIMITED SERVICE;
- the mobile station has responded to paging and thereafter has received the first correct layer 3 message except RR message;
- the mobile station is deactivated (i.e. equipment powered down or SIM removed).

When the timer T3212 expires, the location updating procedure is started and the timer shall be set to its initial value for the next start. If the mobile station is in other state than MM Idle when the timer expires the location updating procedure is delayed until the MM Idle State is entered.

The conditions under which the periodic location updating procedure is used by a mobile station in the MM IDLE state are defined for each service state in clause 4.2.2.

If the mobile station is in service state NO CELL AVAILABLE, LIMITED SERVICE, PLMN SEARCH or PLMN SEARCH-NORMAL SERVICE when the timer expires the location updating procedure is delayed until this service state is left.

In GSM, the (periodic) location updating procedure is not started if the BCCH information at the time the procedure is triggered indicates that periodic location shall not be used. The timeout value is broadcasted in the L3-RR SYSTEM INFORMATION TYPE 3 message on the BCCH, in the Control channel description IE, see GSM 04.18, clause 10.5.2.11.

The T3212 timeout value shall not be changed in the NO CELL AVAILABLE, LIMITED SERVICE, PLMN SEARCH and PLMN SEARCH-NORMAL SERVICE states.

When a change of the T3212 timeout value has to be taken into account and the timer is running (at change of the serving cell or, change of the broadcast value of T3212), the MS shall behave as follows:

Let  $t_1$  be the new T3212 timeout value and let  $t$  be the current timer value at the moment of the change to the new T3212 timeout value; then the timer shall be restarted with the value  $t$  modulo  $t_1$ .

When the mobile station is activated, or when a change of the T3212 timeout value has to be taken into account and the timer is not running, the mobile station shall behave as follows:

Let  $t_1$  be the new T3212 timeout value, the new timer shall be started at a value randomly, uniformly drawn between 0 and  $t_1$ .

## 4.4.3 IMSI attach procedure

The IMSI attach procedure is the complement of the IMSI detach procedure (see clause 4.3.4). It is used to indicate the IMSI as active in the network.

In GSM, a flag (ATT) is broadcast in the L3-RR SYSTEM INFORMATION TYPE 3 message. It indicates whether the attach and detach procedures are required to be used or not.

The IMSI attach procedure is invoked if the detach/attach procedures are required by the network and an IMSI is activated in a mobile station (i.e. activation of a mobile station with plug-in SIM, insertion of a card in a card-operated mobile station etc.) within coverage area from the network or a mobile station with an IMSI activated outside the coverage area enters the coverage area. The IMSI attach procedure is used only if the update status is UPDATED and if the stored Location Area Identification is the same as the one which is actually broadcasted on the BCCH of the current serving cell. Otherwise a normal location updating procedure (see clause 4.4.1) is invoked independently of the ATT flag indication.

IMSI attach is performed by using the location updating procedure. The location updating type information element in the LOCATION UPDATING REQUEST message shall in this case indicate IMSI attach.

#### 4.4.4.1 Location updating initiation by the mobile station

Any timer used for triggering the location updating procedure (e.g. T3211, T3212) is stopped if running.

As no RR connection exists at the time when the location updating procedure has to be started, the MM sublayer within the mobile station will request the RR sublayer to establish a RR connection and enter state WAIT FOR RR CONNECTION (LOCATION UPDATE). The procedure for establishing an RR connection is described in GSM 04.18, clause 3.3.

The mobile station initiates the location updating procedure by sending a LOCATION UPDATING REQUEST message to the network, starts the timer T3210 and enters state LOCATION UPDATING INITIATED. The location updating type information element shall indicate what kind of updating is requested.

#### 4.4.4.4 Security mode setting by the network

In GSM, the security mode setting procedure (see GSM 04.18 clause 3.4.7) may be initiated by the network, e.g. if a new TMSI has to be allocated.

#### 4.4.4.8 Release of RR connection after location updating

When the Location updating procedure is finished (see clauses 4.4.4.6 and 4.4.4.7) the mobile station shall (except in the case where the mobile has a follow-on CM application request pending and has received the follow-on proceed indication, see clause 4.4.4.6) set timer T3240 and enter the state WAIT FOR NETWORK COMMAND, expecting the release of the RR connection. The network may decide to keep the RR connection for network initiated establishment of a MM connection, or to allow for mobile initiated MM connection establishment.

Any release of the RR connection shall be initiated by the network according to clause 3.5 in GSM 04.18. If the RR connection is not released within a given time controlled by the timer T3240, the mobile station shall abort the RR connection. In both cases, either after a RR connection release triggered from the network side or after a RR connection abort requested by the MS-side, the MS shall return to state MM IDLE.

At transition to state MM IDLE, substates NORMAL SERVICE or ATTEMPTING TO UPDATE either timer T3212 or timer T3211 is started as described in clause 4.4.4.9.

## 4.5 Connection management sublayer service provision

The concept of MM connection is introduced in this clause. This concept is mainly a descriptive tool: The establishment of an MM connection by the network can be local (i.e. it is achieved by the transmission of the first CM layer message and without the transmission of any MM layer messages) or can be achieved by the transmission of a CM SERVICE PROMPT message (e.g. in the case of certain ring back services). The release of an MM connection by the network or by the mobile station is always local, i.e. these purposes can be achieved without sending any MM messages over the radio interface. (On the contrary, establishment of an MM connection by the mobile station requires the sending of MM messages over the radio interface. The Mobility Management (MM) sublayer is providing connection management services to the different entities of the upper Connection management (CM) sublayer (see 3GPP TS 24.007). It offers to a CM entity the possibility to use an MM connection for the exchange of information with its peer entity. An MM connection is established and released on request from a CM entity. Different CM entities communicate with their peer entity using different MM connections. Several MM connections may be active at the same time.

An MM connection requires an RR connection. All simultaneous MM connections for a given mobile station use the same RR connection.



In the following clauses, the procedures for establishing, re-establishing, maintaining, and releasing an MM connection are described, usually separately for the mobile station and the network side.

#### 4.5.1.1 MM connection establishment initiated by the mobile station

Upon request of a CM entity to establish an MM connection the MM sublayer first decides whether to accept, delay, or reject this request:

- An MM connection establishment may only be initiated by the mobile station when the following conditions are fulfilled:
  - its update status is UPDATED;
  - the MM sublayer is in one of the states MM IDLE or MM connection active but not in MM connection active (Group call).
- If an MM specific procedure is running at the time the request from the CM sublayer is received, and the LOCATION UPDATING REQUEST message has been sent, the request will either be rejected or delayed, depending on implementation, until the MM specific procedure is finished and, provided that the network has not sent a "follow-on proceed" indication, the RR connection is released. If the LOCATION UPDATING REQUEST message has not been sent, the mobile station may include a "follow-on request" indicator in the message. The mobile station shall then delay the request until the MM specific procedure is completed, when it may be given the opportunity by the network to use the RR connection: see clause 4.4.4.6.

In order to establish an MM connection, the mobile station proceeds as follows:

- a) If no RR connection exists, the MM sublayer requests the RR sublayer to establish an RR connection and enters MM sublayer state WAIT FOR RR CONNECTION (MM CONNECTION). This request contains an establishment cause and a CM SERVICE REQUEST message. When the establishment of an RR connection is indicated by the RR sublayer (this indication implies that the CM SERVICE REQUEST message has been successfully transferred via the radio interface, see clause 2.2), the MM sublayer of the mobile station starts timer T3230, gives an indication to the CM entity that requested the MM connection establishment, and enters MM sublayer state WAIT FOR OUTGOING MM CONNECTION.
- b) If an RR connection is available, the MM sublayer of the mobile station sends a CM SERVICE REQUEST message to the network, starts timer T3230, gives an indication to the CM entity that requested the MM connection establishment, and enters:
  - MM sublayer state WAIT FOR OUTGOING MM CONNECTION, if no MM connection is active;
  - MM sublayer state WAIT FOR ADDITION/AL OUTGOING MM CONNECTION, if at least one MM connection is active;
  - if an RR connection exists but the mobile station is in the state WAIT FOR NETWORK COMMAND then any requests from the CM layer that are received will either be rejected or delayed until this state is left.

The CM SERVICE REQUEST message contains the

- mobile identity according to clause 10.5.1.4;
- mobile station classmark 2;
- ciphering key sequence number; and
- CM service type identifying the requested type of transaction (e.g. mobile originating call establishment, short message service, location services)

A collision may occur when a CM layer message is received by the mobile station in MM sublayer state WAIT FOR OUTGOING MM CONNECTION or in WAIT FOR ADDITION/AL OUTGOING MM CONNECTION. In this case the MM sublayer in the MS shall establish a new MM connection for the incoming CM message as specified in clause 4.5.1.3.

Upon receiving a CM SERVICE REQUEST message, the network shall analyse its content. The type of semantic analysis may depend on other on going MM connection(s). Depending on the type of request and the current status of the RR connection, the network may start any of the MM common procedures and RR procedures.

In GSM, the network may initiate the classmark interrogation procedure, for example, to obtain further information on the mobile station's encryption capabilities.

The identification procedure (see clause 4.3.3) may be invoked for instance if a TMSI provided by the mobile station is not recognized.

The network may invoke the authentication procedure (see clause 4.3.2) depending on the CM service type.

In GSM, the network decides also if the ciphering mode setting procedure shall be invoked (see clause 3.4.7 in GSM 04.18).

In GSM, an indication from the RR sublayer that the ciphering mode setting procedure is completed, or reception of a CM SERVICE ACCEPT message, shall be treated as a service acceptance indication by the mobile station.

The MM connection establishment is completed, timer T3230 shall be stopped, the CM entity that requested the MM connection shall be informed, and MM sublayer state MM CONNECTION ACTIVE is entered. The MM connection is considered to be active.

If the service request cannot be accepted, the network returns a CM SERVICE REJECT message to the mobile station.

The reject cause information element (see clause 10.5.3.6 and annex G) indicates the reason for rejection. The following cause values may apply:

- #4 : IMSI unknown in VLR
- #6 : Illegal ME
- #17 : Network failure
- #22 : Congestion
- #32 : Service option not supported
- #33 : Requested service option not subscribed
- #34 : Service option temporarily out of order

If no other MM connection is active, the network may start the RR connection release (see clause 3.5) when the CM SERVICE REJECT message is sent.

If a CM SERVICE REJECT message is received by the mobile station, timer T3230 shall be stopped, the requesting CM sublayer entity informed. Then the mobile station shall proceed as follows:

- If the cause value is not #4 or #6 the MM sublayer returns to the previous state (the state where the request was received). Other MM connections shall not be affected by the CM SERVICE REJECT message.
- If cause value #4 is received, the mobile station aborts any MM connection, deletes any TMSI, LAI and ciphering key sequence number in the SIM, changes the update status to NOT UPDATED (and stores it in the SIM according to clause 4.1.2.2), and enters the MM sublayer state WAIT FOR NETWORK COMMAND. If subsequently the RR connection is released or aborted, this will force the mobile station to initiate a normal location updating). Whether the CM request shall be memorized during the location updating procedure, is a choice of implementation.
- If cause value #6 is received, the mobile station aborts any MM connection, deletes any TMSI, LAI and ciphering key sequence number in the SIM, changes the update status to ROAMING NOT ALLOWED (and stores it in the SIM according to clause 4.1.2.2), and enters the MM sublayer state WAIT FOR NETWORK COMMAND. The mobile station shall consider the SIM as invalid until switch-off or the SIM is removed.

#### 4.5.1.3.1 Mobile Terminating CM Activity

When a CM sublayer entity in the network requests the MM sublayer to establish a MM connection, the MM sublayer will request the establishment of an RR connection to the RR sublayer if no RR connection to the desired mobile station exists. The MM sublayer is informed when the paging procedure is finished (see GSM 04.18 clause 3.3.2) and the mobile station shall enter the MM state WAIT FOR NETWORK COMMAND.

In GSM, when an RR connection is established (or if it already exists at the time the request is received), the MM sublayer may initiate any of the MM common procedures (except IMSI detach); it may request the RR sublayer to perform the RR classmark interrogation procedure, and/or the security mode setting procedure.

When all MM and RR procedures are successfully completed which the network considers necessary, the MM sublayer will inform the requesting mobile terminating CM sublayer entity on the success of the MM connection establishment.

If an RR connection already exists and no MM specific procedure is running, the network may also establish a new mobile terminating MM connection by sending a CM message with a new PD/TI combination.

In GSM, if the establishment of an RR connection is unsuccessful, or if any of the MM common procedures or the security mode setting fail, this is indicated to the CM layer with an appropriate error cause.

If an RR connection used for a MM specific procedure exists to the mobile station, the CM request may be rejected or delayed depending on implementation. When the MM specific procedure has been completed, the network may use the same RR connection for the delayed CM request.

#### 4.5.1.3.2 Mobile Originating CM Activity \$(CCBS)\$

When a CM sublayer entity in the network requests the MM sublayer to establish a MM connection, the MM sublayer will request the establishment of an RR connection to the RR sublayer if no RR connection to the desired mobile station exists. The MM sublayer is informed when the paging procedure is finished (see GSM 04.18 clause 3.3.2) and the mobile station shall enter the MM state WAIT FOR NETWORK COMMAND.

In GSM, when an RR connection is established (or if it already exists at the time the request is received), the MM sublayer may initiate any of the MM common procedures (except IMSI detach), it may request the RR sublayer to perform the RR classmark interrogation procedure and/or the security mode setting procedure.

The network should use the information contained in *the Mobile Station Classmark Type 2 IE* on the mobile station's support for "Network Initiated MO CM Connection Request" to determine whether to:

- not start this procedure (e.g. if an RR connection already exists);
- to continue this procedure; or
- to release the newly established RR connection.

In the case of a "Network Initiated MO CM Connection Request" the network shall use the established RR connection to send a CM SERVICE PROMPT message to the mobile station.

If the mobile station supports "Network Initiated MO CM Connection Request", the MM sublayer of the MS gives an indication to the CM entity identified by the CM SERVICE PROMPT message and enters the MM sublayer state PROCESS CM SERVICE PROMPT. In the state PROCESS CM SERVICE PROMPT the MM sublayer waits for either the rejection or confirmation of the recall by the identified CM entity. Any other requests from the CM entities shall either be rejected or delayed until this state is left.

When the identified CM entity informs the MM sublayer, that it has send the first CM message in order to start the CM recall procedure the MM sublayer enters the state MM CONNECTION ACTIVE.

If the identified CM entity indicates that it will not perform the CM recall procedure the MM sublayer starts timer T3240 and enter the state WAIT FOR NETWORK COMMAND, expecting the release of the RR connection.

If the CM SERVICE PROMPT message is received by the MS in MM sublayer states WAIT FOR OUTGOING MM CONNECTION or in WAIT FOR ADDITION/AL OUTGOING MM CONNECTION then the mobile station shall send an MM STATUS message with cause "Message not compatible with protocol state".

A mobile that does not support "Network Initiated MO CM Connection Request" shall return an MM STATUS message with cause #97 "message type non-existent or not implemented" to the network.

If the mobile station supports "Network Initiated MO CM Connection Request" but the identified CM entity in the mobile station does not provide the associated support, then the mobile station shall send an MM STATUS message with cause "Service option not supported". In the case of a temporary CM problem (e.g. lack of transaction identifiers) then the mobile station shall send an MM STATUS message with cause "Service option temporarily out of order".

If an RR connection already exists and no MM specific procedure is running, the network may use it to send the CM SERVICE PROMPT message.

In GSM, if the establishment of an RR connection is unsuccessful, or if any of the MM common procedures or the security mode setting fail, this is indicated to the CM layer in the network with an appropriate error cause.

If an RR connection used for a MM specific procedure exists to the mobile station, the "Network Initiated MO CM Connection Request" may be rejected or delayed depending on implementation. When the MM specific procedure has been completed, the network may use the same RR connection for the delayed "Network Initiated MO CM Connection Request".

#### 4.5.1.7 Forced release during MO MM connection establishment

If the mobile station's CM layer initiated the MM connection establishment but the CM layer wishes to abort the establishment prior to the completion of the establishment phase, the mobile station shall send a CM SERVICE ABORT message any time after the completion of the RR connection and not after the first CM message is sent.

If the first CM message has already been sent, the normal release procedure defined by the appropriate CM protocol applies and the CM SERVICE ABORT shall not be sent.

Sending of the CM SERVICE ABORT message is only allowed during the establishment of the first MM connection, where no other MM connection exists in parallel. If parallel MM connections exist already, a new connection establishment cannot be aborted and normal MM connection release according to clause 4.5.3 applies after MM connection establishment.

Upon transmission of the CM SERVICE ABORT message the mobile station shall set timer T3240 and enter the state WAIT FOR NETWORK COMMAND, expecting the release of the RR connection.

Upon receipt of the CM SERVICE ABORT message the network shall abort ongoing processes, release the appropriate resources, and unless another MM connection establishment is pending, initiate a normal release of the RR connection.

If the RR connection is not released within a given time controlled by timer T3240, the mobile station shall abort the RR connection. In both cases, either after a RR connection release triggered from the network side or after a RR connection abort requested by the mobile station side the mobile station shall return to state MM IDLE; the service state depending upon the current update status as specified in clause 4.2.3.

#### 4.7.1.4 Radio resource sublayer address handling

In GSM, while a packet TMSI (P-TMSI) is used in the GMM sublayer for identification of an MS, a temporary logical link identity (TLLI) is used for addressing purposes at the RR sublayer.

##### 4.7.1.4.1 Radio resource sublayer address handling (GSM only)

This clause describes how the RR addressing is managed by GMM. For the detailed coding of the different TLLI types and how a TLLI can be derived from a P-TMSI, see 3GPP TS 23.003.

Two cases can be distinguished:

- a valid P-TMSI is available in the MS; or
  - no valid P-TMSI is available in the MS.
- i) valid P-TMSI available

If the MS has stored a valid P-TMSI, the MS shall derive a foreign TLLI from that P-TMSI and shall use it for transmission of the:

- ATTACH REQUEST message of any GPRS non-combined attach procedure; other GMM messages sent during this procedure shall be transmitted using the same foreign TLLI until the ATTACH ACCEPT message or the ATTACH REJECT message is received; and

- ROUTING AREA UPDATE REQUEST message of a non-combined RAU procedure if the MS has entered a new routing area, or if the GPRS update status is not equal to GU1 UPDATED. Other GMM messages sent during this procedure shall be transmitted using the same foreign TLLI, until the ROUTING AREA UPDATE ACCEPT message or the ROUTING AREA UPDATE REJECT message is received.

After a successful GPRS attach or routing area update procedure, independent whether a new P-TMSI is assigned, if the MS has stored a valid P-TMSI then the MS shall derive a local TLLI from the stored P-TMSI and shall use it for addressing at lower layers.

ii) no valid P-TMSI available

When the MS has not stored a valid P-TMSI, i.e. the MS is not attached to GPRS, the MS shall use a randomly selected random TLLI for transmission of the:

- ATTACH REQUEST message of any non-combined GPRS attach procedure.

The same randomly selected random TLLI value shall be used for all message retransmission attempts and for the cell updates within one attach attempt.

Upon receipt of an ATTACH REQUEST message, the network shall assign a P-TMSI to the MS. The network derives a local TLLI from the assigned P-TMSI, and transmits the assigned P-TMSI to the MS.

Upon receipt of the assigned P-TMSI, the MS shall derive the local TLLI from this P-TMSI and shall use it for addressing at lower layers.

In both cases, the MS shall acknowledge the reception of the assigned P-TMSI to the network. After receipt of the acknowledgement, the network shall use the local TLLI for addressing at lower layers.

## 4.7.2 GPRS Mobility management timers

### 4.7.2.2 Periodic routing area updating

Periodic routing area updating is used to periodically notify the availability of the MS to the network. The procedure is controlled in the MS by the periodic RA update timer, T3312. The value of timer T3312 is sent by the network to the MS in the messages ATTACH ACCEPT and ROUTING AREA UPDATE ACCEPT. The value of the timer T3312 shall be unique within a RA.

In GSM, the timer T3312 is reset and started with its initial value, when the READY timer is stopped or expires. The timer T3312 is stopped and shall be set to its initial value for the next start when the READY timer is started. If after a READY timer negotiation the READY timer value is set to zero, timer T3312 is reset and started with its initial value. If the initial READY timer value is zero, the timer T3312 is reset and started with its initial value, when the ROUTING AREA UPDATE REQUEST message is transmitted.

When timer T3312 expires, the periodic routing area updating procedure shall be started and the timer shall be set to its initial value for the next start.

If the MS is in other state than GMM-REGISTERED.NORMAL-SERVICE when the timer expires the periodic routing area updating procedure is delayed until the MS returns to GMM-REGISTERED.NORMAL-SERVICE.

The network supervises the periodic routing area updating procedure by means of the Mobile Reachable timer. The Mobile Reachable timer shall be longer than the periodic RA update timer. When the Mobile Reachable timer expires, typically the network stops sending paging messages to the mobile and may take other appropriate actions.

In GSM, the Mobile Reachable timer is reset and started with its initial value, when the READY timer is stopped or expires. The Mobile Reachable timer is stopped and shall be set to its initial value for the next start when the READY timer is started.

In GSM, if after a READY timer negotiation the READY timer value is set to zero the Mobile Reachable timer is reset and started with its initial value. If the initial READY timer value is zero, the Mobile Reachable is reset and started with its initial value, when the ROUTING AREA UPDATE REQUEST message is received.

In GSM, timer T3312 shall not be stopped when a GPRS MS enters state GMM-REGISTERED.SUSPENDED.

### 4.7.3 GPRS attach procedure

The GPRS attach procedure is used for one purpose:

- normal GPRS attach, performed by the MS to IMSI attach for GPRS services only. The normal GPRS attach procedure shall be used by GPRS MSs in MS operation mode C, independent of the network operation mode.

With a successful GPRS attach procedure a GMM context is established.

Clause 4.7.3.1 describes the GPRS attach procedure to attach the IMSI only for GPRS services.

If an IMSI attach for non-GPRS services is requested and a GMM context exists, the routing area updating procedure shall be used as described in clause 4.7.5.2.

To limit the number of subsequently rejected attach attempts, a GPRS attach attempt counter is introduced. The GPRS attach attempt counter shall be incremented as specified in clause 4.7.3.1.5. Depending on the value of the GPRS attach attempt counter, specific actions shall be performed. The GPRS attach attempt counter shall be reset when:

- the MS is powered on;
- a SIM is inserted;
- a GPRS attach procedure is successfully completed; or
- a GPRS attach procedure is completed with cause #11, #12 or #13,

and additionally when the MS is in substate ATTEMPTING-TO-ATTACH:

- expiry of timer T3302;
- a new routing area is entered; or
- an attach is triggered by CM sublayer requests.

The mobile equipment shall contain a list of "forbidden location areas for roaming", as well as a list of "forbidden location areas for regional provision of service". The handling of these lists is described in clause 4.4.1; the same lists are used by GMM and MM procedures.

#### 4.7.3.1.1 GPRS attach procedure initiation

In state GMM-DEREGISTERED, the MS initiates the GPRS attach procedure by sending an ATTACH REQUEST message to the network, starts timer T3310 and enters state GMM-REGISTERED-INITIATED.

The MS capable GSM system shall include a valid P-TMSI, if any is available, the P-TMSI signature associated with the P-TMSI and the routing area identity associated with the P-TMSI in the ATTACH REQUEST message. If there is no valid P-TMSI available, the IMSI shall be included instead of the P-TMSI and P-TMSI signature.

The MS shall also indicate within the DRX parameters whether it supports the split pg cycle option on CCCH. The optional support of the split pg cycle on CCCH by the network is indicated in SI13 or PSII. Split pg cycle on CCCH is applied by both the network and the MS when the split pg cycle option is supported by both (see GSM 05.02).

#### 4.7.3.1.3 GPRS attach accepted by the network

If the GPRS attach request is accepted by the network, an ATTACH ACCEPT message is sent to the MS.

The P-TMSI reallocation may be part of the GPRS attach procedure. The P-TMSI that shall be allocated is then included in the ATTACH ACCEPT message together with the routing area identifier. The network shall, in this case, change to state GMM-COMMON-PROCEDURE-INITIATED and shall start timer T3350 as described in clause 4.7.6. Furthermore, the network may assign a P-TMSI signature for the GMM context which is then also included in the ATTACH ACCEPT message. If the LAI or PLMN identity that has been transmitted in the ATTACH ACCEPT message is a member of any of the "forbidden" lists, any such entry shall be deleted. Additionally, the network shall include the radio priority level to be used by the MS for mobile originated SMS transfer in the ATTACH ACCEPT message.

In GSM, the Cell Notification information element shall be included in the ATTACH ACCEPT message by the network which indicates that the Cell Notification is supported by the network.

The MS, receiving an ATTACH ACCEPT message, stores the received routing area identification, stops timer T3310, reset the GPRS attach attempt counter, reset the routing area updating attempt counter, enters state GMM-REGISTERED and sets the GPRS update status to GU1 UPDATED.

If the message contains a P-TMSI, the MS shall use this P-TMSI as the new temporary identity for GPRS services. In this case, an ATTACH COMPLETE message is returned to the network. The MS shall delete its old P-TMSI and shall store the new one. If no P-TMSI has been included by the network in the ATTACH ACCEPT message, the old P-TMSI, if any available, shall be kept.

If the message contains a P-TMSI signature, the MS shall use this P-TMSI signature as the new temporary signature for the GMM context. The MS shall delete its old P-TMSI signature, if any is available, and shall store the new one. If the message contains no P-TMSI signature, the old P-TMSI signature, if available, shall be deleted.

In GSM, if the ATTACH ACCEPT message contains the Cell Notification information element, then the MS shall start to use the LLC NULL frame to perform cell updates. The network receiving an ATTACH COMPLETE message stops timer T3350, changes to GMM-REGISTERED state and considers the P-TMSI sent in the ATTACH ACCEPT message as valid.

#### 4.7.3.1.5 Abnormal cases in the MS

The following abnormal cases can be identified:

- a) Access barred because of access class control

The GPRS attach procedure shall not be started. The MS stays in the current serving cell and applies normal cell reselection process. The GPRS attach procedure is started as soon as possible, i.e. when access is granted or because of a cell change.

- b) Lower layer failure before the ATTACH ACCEPT or ATTACH REJECT message is received

The procedure shall be aborted. The MS shall proceed as described below.

- c) T3310 time-out

On the first expiry of the timer, the MS reset and restart timer T3310 and shall retransmit the ATTACH REQUEST message. This retransmission is repeated four times, i.e. on the fifth expiry of timer T3310, the GPRS attach procedure shall be aborted and the MS shall proceed as described below.

- d) ATTACH REJECT, other causes than those treated in clause 4.7.3.1.4

The MS shall proceed as described below.

- e) Change of cell within the same RA (GSM only)

If a cell change occurs within the same RA when the MS is in state GMM-REGISTERED-INITIATED, then the cell update procedure shall be performed before completion of the attach procedure.

## f) Change of cell into a new routing area

If a cell change into a new routing area occurs before an ATTACH ACCEPT or ATTACH REJECT message has been received, the GPRS attach procedure shall be aborted and re-initiated immediately. If a routing area border is crossed when the ATTACH ACCEPT message is received but before an ATTACH COMPLETE message is sent, the GPRS attach procedure shall be aborted and the routing area updating procedure shall be initiated. If a P-TMSI was allocated during the GPRS attach procedure, this P-TMSI shall be used in the routing area updating procedure. If a P-TMSI signature was allocated together with the P-TMSI during the GPRS attach procedure, this P-TMSI signature shall be used in the routing area updating procedure.

## g) Mobile originated detach required

If the MS is in state GMM-REGISTERED-INITIATED, the GPRS attach procedure shall be aborted and the GPRS detach procedure shall be performed (see clause 4.7.4.1).

## h) Procedure collision

If the MS receives a DETACH REQUEST message from the network in state GMM-REGISTERED-INITIATED with type of detach 're-attach not required', the GPRS detach procedure shall be progressed and the GPRS attach procedure shall be aborted. Otherwise the GPRS attach procedure shall be progressed and the DETACH REQUEST message shall be ignored.

In cases b, c and d the MS shall proceed as follows. Timer T3310 shall be stopped if still running. The GPRS attach attempt counter shall be incremented.

If the GPRS attach attempt counter is less than 5:

- timer T3311 is started and the state is changed to GMM-DEREGISTERED.ATTEMPTING-TO-ATTACH.

If the GPRS attach attempt counter is greater than or equal to 5:

- the MS shall delete any RAI, P-TMSI, P-TMSI signature, and GPRS ciphering key sequence number, shall set the GPRS update status to GU2 NOT UPDATED, shall start timer T3302. The state is changed to GMM-DEREGISTERED..ATTEMPTING-TO-ATTACH or optionally to GMM-DEREGISTERED.PLMN-SEARCH (see clause 4.2.4.1.2).

#### 4.7.3.1.6 Abnormal cases on the network side

The following abnormal cases can be identified:

## a) Lower layer failure

If a low layer failure occurs before the message ATTACH COMPLETE has been received from the MS and a new P-TMSI (or a new P-TMSI and a new P-TMSI signature) has been assigned, the network shall consider both the old and new P-TMSI each with its corresponding P-TMSI-signature as valid until the old P-TMSI can be considered as invalid by the network (see clause 4.7.1.5) and shall not resent the message ATTACH ACCEPT. During this period the network may:

- use the identification procedure followed by a P-TMSI reallocation procedure if the old P-TMSI is used by the MS in a subsequent message.

## b) Protocol error

If the ATTACH REQUEST message is received with a protocol error, the network shall return an ATTACH REJECT message with one of the following reject causes:

- #96: Mandatory information element error;
- #99: Information element non-existent or not implemented;
- #100: Conditional IE error;
- #111: Protocol error, unspecified.



## c) T3350 time-out

On the first expiry of the timer, the network shall retransmit the ATTACH ACCEPT message and shall reset and restart timer T3350.

This retransmission is repeated four times, i.e. on the fifth expiry of timer T3350, the GPRS attach procedure shall be aborted. If a new P-TMSI or a new P-TMSI together with a new P-TMSI signature were allocated in the ATTACH ACCEPT message, the network shall consider both the old and new P-TMSI each together with the corresponding P-TMSI signatures as valid until the old P-TMSI can be considered as invalid by the network (see clause 4.7.1.5). During this period the network acts as specified for case a.

## d.1) ATTACH REQUEST received

- If one or more of the information elements in the ATTACH REQUEST message differ from the ones received within the previous ATTACH REQUEST message, the previously initiated GPRS attach procedure shall be aborted and the new GPRS attach procedure shall be progressed; or
- if no information element differ, then the ATTACH ACCEPT message shall be resent.

## d.2) More than one ATTACH REQUEST received and no ATTACH ACCEPT or ATTACH REJECT message has been sent

- If one or more of the information elements in the ATTACH REQUEST message differs from the ones received within the previous ATTACH REQUEST message, the previously initiated GPRS attach procedure shall be aborted and the new GPRS attach procedure shall be progressed;
- if the information elements do not differ, then the network shall continue with the previous attach procedure and shall not treat any further this ATTACH REQUEST message.

## e) ATTACH REQUEST received in state GMM-REGISTERED

If an ATTACH REQUEST message is received in state GMM-REGISTERED the network may initiate the GMM common procedures; if it turned out that the ATTACH REQUEST message was send by an MS that has already been attached, the GMM context and PDP contexts, if any, are deleted and the new ATTACH REQUEST is progressed.

## f) ROUTING AREA UPDATE REQUEST message received before ATTACH COMPLETE message.

Timer T3350 shall be stopped. The allocated P-TMSI shall be considered as valid and the routing area updating procedure shall be progressed as described in clause 4.7.5.

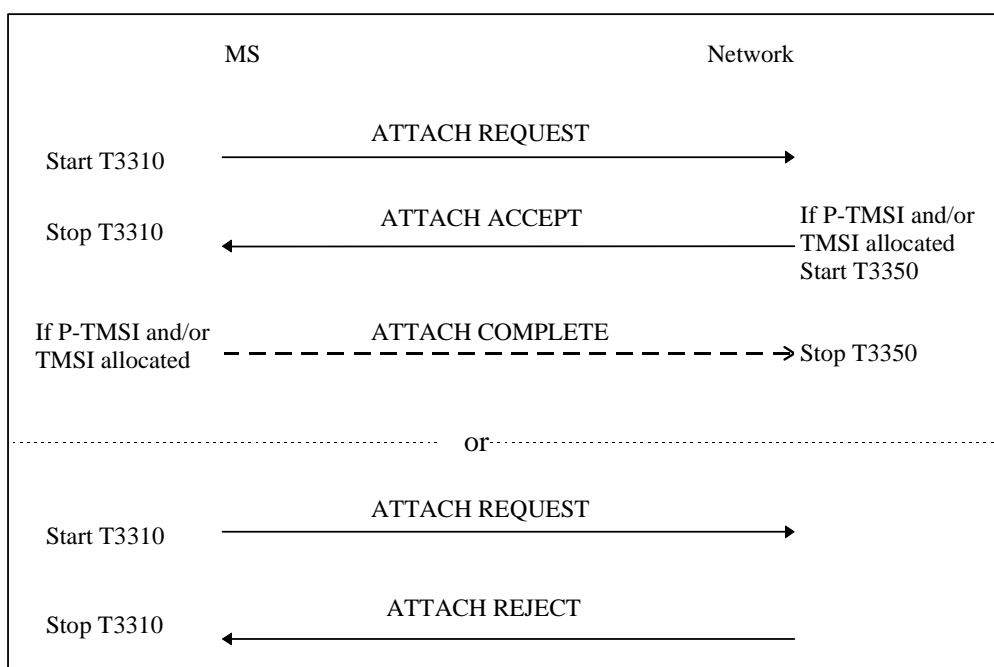

Figure 4.7.3/1 3GPP TS 24.008: GPRS attach procedure

## 4.7.4 GPRS detach procedure

The GPRS detach procedure is used:

- to detach the IMSI for GPRS services only. Independent of the network operation mode, this procedure is used by all kind of GPRS MSs;
- in the case of a network failure condition to indicate to the MS that a re-attach with successive activation of previously active PDP contexts shall be performed.

After completion of a GPRS detach procedure the GMM context is released.

The GPRS detach procedure shall be invoked by the MS if the MS is switched off, the SIM card is removed from the MS or if the GPRS or non-GPRS capability of the MS is disabled. The procedure may be invoked by the network to detach the IMSI for GPRS services. The GPRS detach procedure causes the MS to be marked as inactive in the network for GPRS services, non-GPRS services or both services.

In GSM, if the GPRS detach procedure is performed, the PDP contexts are deactivated locally without peer-to-peer signalling between the SM and LLC entities in the MS and the network.

### 4.7.4.1.1 MS initiated GPRS detach procedure initiation

The GPRS detach procedure is initiated by the MS by sending a DETACH REQUEST message. The detach type information element may indicate "GPRS detach with switching off", "GPRS detach without switching off", "IMSI detach", "GPRS/IMSI detach with switching off" or "GPRS/IMSI detach without switching off".

The MS shall include the P-TMSI in the DETACH REQUEST message. The MS shall also include a valid P-TMSI signature, if available.

If the MS is not switched off and the MS is in the state GMM\_REGISTERED, timer T3321 shall be started after the DETACH REQUEST message has been sent. If the detach type information element value indicates "IMSI Detach" the MS shall enter GMM-REGISTERED.IMSI-DETACH\_INITIATED, otherwise the MS shall enter the state GMM-DEREGISTERED-INITIATED. If the MS is to be switched off, the MS shall try for a period of 5 seconds to send the DETACH REQUEST message. If the MS is able to send the DETACH REQUEST message during this time the MS may be switched off.

If the detach type information element value indicates "GPRS detach without switching off" and the MS is attached for GPRS and non-GPRS services and the network operates in network operation mode I, then if in the MS the timer T3212 is not already running, the timer T3212 shall be set to its initial value and restarted after the DETACH REQUEST message has been sent.

### 4.7.4.1.2 MS initiated GPRS detach procedure completion for GPRS services only

When the DETACH REQUEST message is received by the network, the network shall send a DETACH ACCEPT message to the MS, if the detach type IE value indicates that the detach request has not been sent due to switching off. If switching off was indicated, the procedure is completed when the network receives the DETACH REQUEST message. The network and the MS shall deactivate the PDP contexts and deactivate the logical link(s), if any.

The MS is marked as inactive in the network for GPRS services; state GMM-DEREGISTERED is entered in the MS and the network.

### 4.7.4.2.2 Network initiated GPRS detach procedure completion by the MS

When receiving the DETACH REQUEST message and the detach type IE indicates "re-attach not required" or "re-attach required", the MS shall deactivate the PDP contexts and deactivate the logical link(s), if any. The MS shall then send a DETACH ACCEPT message to the network and shall change state to GMM-DEREGISTERED. The MS shall, after the completion of the GPRS detach procedure, initiate a GPRS attach procedure if indicated by the network in the detach type IE.

When receiving the DETACH REQUEST message and the detach type IE indicates "IMSI detach", the MS shall not deactivate the PDP contexts. The MS shall set the MM update status to U2 NOT UPDATED. A MS in operation mode C shall send a DETACH ACCEPT message to the network.

If the detach type IE indicates "IMSI detach", or "re-attach required" then the MS shall ignore the cause code if received.

If the detach type information element value indicates "re-attach required" or "re-attach not required" and the MS is attached for GPRS and non-GPRS services and the network operates in network operation mode I, then if in the MS the timer T3212 is not already running, the timer T3212 shall be set to its initial value and restarted.

If the detach type IE indicates "re-attach required", the MS shall perform a new attach procedure. The MS should also activate PDP context(s) to replace any previously active PDP contexts.

NOTE: In some cases, user interaction may be required and then the MS cannot activate the PDP context(s) automatically.

If the detach type IE indicates "re-attach not required", then, depending on the received cause code, the MS shall act as follows:

# 2 (IMSI unknown in HLR)

The MS shall set the update status to U3 ROAMING NOT ALLOWED and shall delete any TMSI, LAI and ciphering key sequence number. The new MM state is MM IDLE. The SIM shall be considered as invalid for non-GPRS services until switching off or the SIM is removed.

# 3 (Illegal MS); or

# 6 (Illegal ME)

The MS shall set the GPRS update status to GU3 ROAMING NOT ALLOWED (and shall store it according to clause 4.1.3.2) and shall delete any P-TMSI, P-TMSI signature, RAI and GPRS ciphering key sequence number. The new GMM state is GMM-DEREGISTERED. The SIM shall be considered as invalid for GPRS services until switching off or the SIM is removed.

# 7 (GPRS services not allowed)

The MS shall set the GPRS update status to GU3 ROAMING NOT ALLOWED (and shall store it according to clause 4.1.3.2) and shall delete any P-TMSI, P-TMSI signature, RAI and GPRS ciphering key sequence number. The SIM shall be considered as invalid for GPRS services until switching off or the SIM is removed. The new state is GMM-DEREGISTERED.

# 8 (GPRS services and non-GPRS services not allowed)

The MS shall set the GPRS update status to GU3 ROAMING NOT ALLOWED and the update status to U3 ROAMING NOT ALLOWED (and shall store it according to clause 4.1.3.2). Furthermore, it shall delete any P-TMSI, P-TMSI signature, TMSI, RAI, LAI, ciphering key sequence number and GPRS ciphering key sequence number and shall consider the SIM as invalid for GPRS and non-GPRS services until switching off or the SIM is removed.

# 11 (PLMN not allowed);

# 12 (Location area not allowed); or

# 13 (Roaming not allowed in this location area).

The MS shall delete any RAI or LAI, P-TMSI, P-TMSI signature and GPRS ciphering key sequence number, shall set the GPRS update status to GU3 ROAMING NOT ALLOWED (and shall store it according to clause 4.1.3.2).

The MS shall store the LAI or the PLMN identity in the appropriate forbidden list, i.e. in the "forbidden PLMN list" for cause #11, in the list of "forbidden location areas for regional provision of service" for cause #12 or in the list of "forbidden location areas for roaming" for cause #13. If #11 or #13 was received, the MS shall perform a PLMN selection instead of a cell selection.

Other cause values shall not impact the update status. Further actions of the MS are implementation dependent.

## 4.7.5 Routing area updating procedure

This procedure is used for:

- normal routing area updating to update the registration of the actual routing area of an MS in the network. This procedure is used by GPRS MSs in MS operation mode C;
- periodic routing area updating. This procedure is used by GPRS MSs in MS operation mode C independent of the network operation mode;
- in GSM, resuming GPRS services when the RR sublayer indicated a resumption failure after dedicated mode was left, see GSM 04.18.

Clause 4.7.5.1 describes the routing area updating procedures for updating the routing area only. The combined routing area updating procedure used to update both the routing and location area is described in clause 4.7.5.2.

The routing area updating procedure is always initiated by the MS. It is only invoked in state GMM-REGISTERED.

To limit the number of subsequently rejected routing area update attempts, a routing area updating attempt counter is introduced. The routing area updating attempt counter shall be incremented as specified in clause 4.7.5.1.5. Depending on the value of the routing area updating attempt counter, specific actions shall be performed. The routing area updating attempt counter shall be reset when:

- a GPRS attach procedure is successfully completed; or
- a routing area updating procedure is successfully completed;

and additionally when the MS is in substate ATTEMPTING-TO-UPDATE:

- a new routing area is entered;
- expiry of timer T3302; or
- at request from registration function.

The mobile equipment shall contain a list of "forbidden location areas for roaming", as well as a list of "forbidden location areas for regional provision of service". The handling of these lists is described in clause 4.4.1.

In, GSM, user data transmission in the MS shall be suspended during the routing area updating procedure; user data reception shall be possible. User data transmission in the network shall be suspended during the routing area updating procedure, if a new P-TMSI is assigned.

### 4.7.5.1 Normal and periodic routing area updating procedure

Periodic routing area updating is used to periodically notify the availability of the MS to the network. The value of the update type IE in the ROUTING AREA UPDATE REQUEST message shall indicate "periodic updating". The procedure is controlled in the MS by timer T3312. When timer T3312 expires, the periodic routing area updating procedure is started. Start and reset of timer T3312 is described in clause 4.7.2.2.

In GSM, the normal routing area updating procedure is initiated when the MS detects a change of the routing area in state GMM-REGISTERED, or when the MS determines that GPRS resumption shall be performed. The ROUTING AREA UPDATE REQUEST message shall always be the first data sent by the MS when a routing area border is crossed. The routing area identification is broadcast on the broadcast channel(s).

A normal routing area updating shall abort any ongoing GMM procedure. Aborted GMM procedures may be repeated after the normal routing area updating procedure has been successfully performed. The value of the update type IE included in the message shall indicate "normal routing area updating".

#### 4.7.5.1.1 Normal and periodic routing area updating procedure initiation

To initiate the normal routing area updating procedure, the MS sends the message ROUTING AREA UPDATE REQUEST to the network, starts timer T3330 and changes to state GMM-ROUTING-AREA-UPDATING-INITIATED. The message ROUTING AREA UPDATE REQUEST shall contain the P-TMSI signature when received within a previous ATTACH ACCEPT or ROUTING AREA UPDATE ACCEPT message.

#### 4.7.5.1.3 Normal and periodic routing area updating procedure accepted by the network

If the routing area updating request has been accepted by the network, a ROUTING AREA UPDATE ACCEPT message shall be sent to the MS. The network may assign a new P-TMSI and/or a new P-TMSI signature for the MS. If a new P-TMSI and/or P-TMSI signature have been assigned to the MS, it/they shall be included in the ROUTING AREA UPDATE ACCEPT message together with the routing area identification.

In GSM the Cell Notification information element shall be included in the ROUTING AREA UPDATE ACCEPT message in order to indicate the ability of the network to support the Cell Notification.

The network shall change to state GMM-COMMON-PROCEDURE-INITIATED and shall start the supervision timer T3350 as described in clause 4.7.6.

If the LAI or PLMN identity contained in the ROUTING AREA UPDATE ACCEPT message is a member of any of the "forbidden" lists then any such entry shall be deleted.

Upon receipt of a ROUTING AREA UPDATE ACCEPT message, the MS stores the received routing area identification, stops timer T3330, shall reset the routing area updating attempt counter and sets the GPRS update status to GU1 UPDATED. If the message contains a P-TMSI, the MS shall use this P-TMSI as new temporary identity for GPRS services and shall store the new P-TMSI. If no P-TMSI was included by the network in the ROUTING AREA UPDATING ACCEPT message, the old P-TMSI shall be kept. Furthermore, the MS shall store the P-TMSI signature if received in the ROUTING AREA UPDATING ACCEPT message. If no P-TMSI signature was included in the message, the old P-TMSI signature, if available, shall be deleted.

In GSM, if the ROUTING AREA UPDATE ACCEPT message contains the Cell Notification information element, then the MS shall start to use the LLC NULL frame to perform cell updates.

A ROUTING AREA UPDATE COMPLETE message shall be returned to the network if the ROUTING AREA UPDATE ACCEPT message contained:

- a P-TMSI; and/or
- Receive N-PDU Numbers (see 3GPP TS 04.65).

In this case the Receive N-PDU Numbers values valid in the MS, shall be included in the ROUTING AREA UPDATE COMPLETE message.

#### 4.7.5.1.5 Abnormal cases in the MS

The following abnormal cases can be identified:

- a) Access barred because of access class control

The routing area updating procedure shall not be started. The MS stays in the current serving cell and applies the normal cell reselection process. The procedure is started as soon as possible and if still necessary, i.e. when the barred state is removed or because of a cell change.

- b) Lower layer failure before the ROUTING AREA UPDATE ACCEPT or ROUTING AREA UPDATE REJECT message is received

The procedure shall be aborted. The MS shall proceed as described below.

- c) T3330 time-out

The procedure is restarted four times, i.e. on the fifth expiry of timer T3330, the MS shall abort the procedure. The MS shall proceed as described below.

- d) ROUTING AREA UPDATE REJECT, other causes than those treated in clause 4.7.5.1.4

The MS shall proceed as described below.

- e) If a routing area border is crossed, when the MS is in state GMM-ROUTING-AREA-UPDATE-INITIATED, the routing area updating procedure shall be aborted and re-initiated immediately. The MS shall set the GPRS update status to GU2 NOT UPDATED.

f) In GSM, if a cell change occurs within the same RA, when the MS is in state GMM-ROUTING-AREA-UPDATE-INITIATED, the cell update procedure is performed, before completion of the routing area updating procedure.

g) Routing area updating and detach procedure collision

GPRS detach containing detach type "re-attach required" or "re-attach not required":

If the MS receives a DETACH REQUEST message before the routing area updating procedure has been completed, the routing area updating procedure shall be aborted and the GPRS detach procedure shall be progressed.

GPRS detach containing detach type "IMSI detach":

If the MS receives a DETACH REQUEST message before the routing area updating procedure has been completed, the routing area updating procedure shall be progressed, i.e. the DETACH REQUEST message shall be ignored.

h) Routing area updating and P-TMSI reallocation procedure collision

If the MS receives a P-TMSI REALLOCATION REQUEST message before the routing area updating procedure has been completed, the P-TMSI reallocation procedure shall be aborted and the routing area updating procedure shall be progressed.

In cases b, c and d the MS shall proceed as follows:

Timer T3330 shall be stopped if still running. The routing area updating attempt counter shall be incremented.

If the routing area updating attempt counter is less than 5, and the stored RAI is equal to the RAI of the current serving cell and the GMM update status is equal to GU1 UPDATED:

- the MS shall keep the GMM update status to GU1 UPDATED and changes state to GMM-REGISTERED.NORMAL-SERVICE. The MS shall start timer T3311. When timer T3311 expires the routing area updating procedure is triggered again.

If the routing area updating attempt counter is less than 5, and the stored RAI is different to the RAI of the current serving cell or the GMM update status is different to GU1 UPDATED:

- the MS shall start timer T3311, shall set the GPRS update status to GU2 NOT UPDATED and changes state to GMM-REGISTERED.ATTEMPTING-TO-UPDATE.
- If the routing area updating attempt counter is greater than or equal to 5:
  - the MS shall start timer T3302, shall set the GPRS update status to GU2 NOT UPDATED and shall change to state GMM-REGISTERED.ATTEMPTING-TO-UPDATE or optionally to GMM-REGISTERED.PLMN-SEARCH (see clause 4.2.4.1.2).

#### 4.7.5.1.6 Abnormal cases on the network side

The following abnormal cases can be identified:

- a) If a lower layer failure occurs before the message ROUTING AREA UPDATE COMPLETE has been received from the MS and a P-TMSI and/or PTMSI signature has been assigned, the network shall abort the procedure and shall consider both, the old and new P-TMSI and the corresponding P-TMSI signatures as valid until the old P-TMSI can be considered as invalid by the network (see clause 4.7.1.5). During this period the network may use the identification procedure followed by a P-TMSI reallocation procedure if the old P-TMSI is used by the MS in a subsequent message.

NOTE: Optionally, paging with IMSI may be used if paging with old and new P-TMSI fails. Paging with IMSI causes the MS to re-attach as described in clause 4.7.9.1.

## b) Protocol error

If the ROUTING AREA UPDATE REQUEST message has been received with a protocol error, the network shall return a ROUTING AREA UPDATE REJECT message with one of the following reject causes:

- #96: Mandatory information element error;
- #99: Information element non-existent or not implemented;
- #100: Conditional IE error;
- #111: Protocol error, unspecified.

## c) T3350 time-out

On the first expiry of the timer, the network shall retransmit the ROUTING AREA UPDATE ACCEPT message and shall reset and restart timer T3350. The retransmission is performed four times, i.e. on the fifth expiry of timer T3350, the routing area updating procedure is aborted. Both, the old and the new P-TMSI and the corresponding P-TMSI signatures shall be considered as valid until the old P-TMSI can be considered as invalid by the network(see clause 4.7.1.5). During this period the network acts as described for case a above.

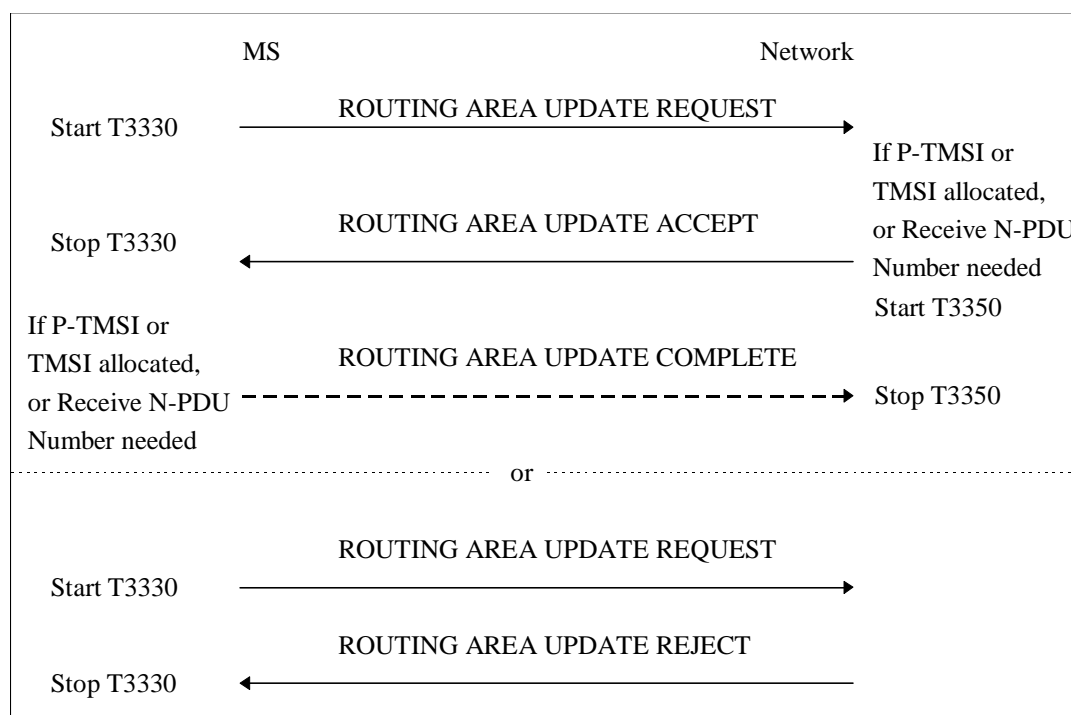

Figure 4.7.5/1 3GPP TS 24.008: Routing area updating procedure

#### 4.7.7b Authentication and ciphering procedure used for GSM authentication challenge

The purpose of the authentication and ciphering procedure is threefold (see 3GPP TS 03.20):

- to permit the network to check whether the identity provided by the MS is acceptable or not;
- to provide parameters enabling the MS to calculate a new GPRS GSM ciphering key; and
- to let the network set the GSM ciphering mode (ciphering/no ciphering) and GSM ciphering algorithm.

The authentication and ciphering procedure can be used for either:

- authentication only;
- setting of the GSM ciphering mode and the GSM ciphering algorithm only; or
- authentication and the setting of the GSM ciphering mode and the GSM ciphering algorithm.

The cases in which the authentication and ciphering procedure shall be used are defined in GSM 02.09.

In GSM, the authentication and ciphering procedure is always initiated and controlled by the network. It shall be performed in a non-ciphered mode because of the following reasons:

- the network cannot decipher a ciphered AUTHENTICATION AND CIPHERING RESPONSE from an unauthorized MS and put it on the black list; and
- to be able to define a specific point in time from which on a new GPRS GSM ciphering key should be used instead of the old one.

GSM authentication challenge shall be supported by a ME supporting GSM radio access.

In GSM, the network should not send any user data during the authentication and ciphering procedure.

A GSM security context is established in the MS and the network when a GSM authentication challenge is performed in GSM. After a successful GSM authentication challenge, the GPRS GSM ciphering key and the GPRS ciphering key sequence number, are stored both in the network and the MS.

#### 4.7.7.1 Authentication and ciphering initiation by the network

The network initiates the authentication and ciphering procedure by transferring an AUTHENTICATION AND CIPHERING REQUEST message across the radio interface and starts timer T3360. The AUTHENTICATION AND CIPHERING REQUEST message shall contain all parameters necessary to calculate the response parameters when authentication is performed (see 3GPP TS 03.20).

If authentication is requested, then the AUTHENTICATION AND CIPHERING REQUEST message shall contain either:

- in a GSM authentication challenge, the GPRS ciphering key sequence number, allocated to the GPRS GSM ciphering key and the RAND;
- in GSM, if authentication is not requested, then the AUTHENTICATION AND CIPHERING REQUEST message shall not contain neither the GPRS ciphering key sequence number, the RAND nor the AUTN; or
- in GSM, if ciphering is requested, in a GSM authentication challenge, then the AUTHENTICATION AND CIPHERING REQUEST message shall indicate the GPRS GSM ciphering algorithm.

The network includes the A&C reference number information element in the AUTHENTICATION AND CIPHERING REQUEST message. Its value is chosen in order to link an AUTHENTICATION AND CIPHERING REQUEST in a RA with its RESPONSE. The A&C reference number value might be based on the RA Colour Code value.

Additionally, the network may request the MS to include its IMEISV in the AUTHENTICATION AND CIPHERING RESPONSE message.



#### 4.7.7.2 Authentication and ciphering response by the MS

In GSM, a MS that is attached to GPRS shall be ready to respond upon an AUTHENTICATION AND CIPHERING REQUEST message at any time.

In a GSM authentication challenge, if the AUTHENTICATION AND CIPHERING REQUEST message includes the authentication parameters RAND and GPRS CKSN, then upon receipt of the message, the MS processes the challenge information and sends an AUTHENTICATION AND CIPHERING RESPONSE message to the network. The value of the received A&C reference number information element shall be copied into the A&C reference number information element in the AUTHENTICATION AND CIPHERING RESPONSE message. A GSM authentication challenge will result in the SIM passing a SRES and a GPRS GSM ciphering key to the ME. The new GPRS GSM ciphering key calculated from the challenge information shall overwrite the previous one and any previously stored GPRS UMTS ciphering and GPRS UMTS integrity keys shall be deleted. The calculated GSM ciphering key shall be stored on the SIM together with the GPRS ciphering key sequence number before the AUTHENTICATION AND CIPHERING RESPONSE message is transmitted.

If the AUTHENTICATION AND CIPHERING REQUEST message does not include neither the GSM authentication parameters (RAND and GPRS CKSN) nor the UMTS authentication parameters (RAND, AUTN and GPRS CKSN), then upon receipt of the message, the MS replies by sending an AUTHENTICATION AND CIPHERING RESPONSE message to the network.

In GSM, the GMM layer shall notify the LLC layer if ciphering shall be used or not and if yes which GSM ciphering algorithm and GPRS GSM ciphering key that shall be used (see 3GPP TS 04.64).

#### 4.7.7.3 Authentication and ciphering completion by the network

Upon receipt of the AUTHENTICATION AND CIPHERING RESPONSE message, the network stops the timer T3360 and checks the validity of the response (see 3GPP TS 03.20). For this, it may use the A&C reference number information element within the AUTHENTICATION AND CIPHERING RESPONSE message to determine whether the response is correlating to the last request that was sent.

In GSM, the GMM layer shall notify the LLC sublayer if ciphering shall be used or not and if yes which algorithm and GPRS GSM ciphering key that shall be used (see 3GPP TS 04.64).

Upon receipt of the AUTHENTICATION AND CIPHERING FAILURE message, the network stops the timer T3360. In Synch failure case, the core network may renegotiate with the HLR/AuC and provide the MS with new authentication parameters.

#### 4.7.7.4 GPRS ciphering key sequence number

The security parameters for authentication and ciphering are tied together in sets. In a GSM authentication challenge, from a challenge parameter RAND both the authentication response parameter SRES and the GPRS GSM ciphering key can be computed given the secret key associated to the IMSI.

In order to allow start of ciphering on a logical link without authentication, GPRS ciphering key sequence numbers are introduced.

The GPRS ciphering key sequence number is managed by the network such that the AUTHENTICATION AND CIPHERING REQUEST message contains the GPRS ciphering key sequence number allocated to the GPRS GSM ciphering key (in case of a GSM authentication challenge) which may be computed from the RAND parameter carried in that message.

The MS stores the GPRS ciphering key sequence number with the GPRS GSM ciphering key (in case of a GSM authentication challenge), and includes the corresponding GPRS ciphering key sequence number in the ROUTING AREA UPDATE REQUEST, SERVICE REQUEST and ATTACH REQUEST messages.

If the GPRS ciphering key sequence number is deleted, the associated GPRS GSM ciphering key, GPRS UMTS ciphering key and GPRS UMTS integrity key shall be deleted (i.e. the established GSM security context or the UMTS security context is no longer valid).

In GSM, the network may choose to start ciphering with the stored GPRS GSM ciphering key (under the restrictions given in GSM 02.09) if the stored GPRS ciphering key sequence number and the one given from the MS are equal and the previously negotiated ciphering algorithm is known and supported in the network. When ciphering is requested at GPRS attach, the authentication and ciphering procedure shall be performed since the MS does not store the ciphering algorithm at detach.

Upon GPRS attach, if ciphering is to be used, an AUTHENTICATION AND CIPHERING REQUEST message shall be sent to the MS to start ciphering.

If the GPRS ciphering key sequence number stored in the network does not match the GPRS ciphering key sequence number received from the MS in the ATTACH REQUEST message, then the network should authenticate the MS.

In GSM, the MS starts ciphering after sending the AUTHENTICATION AND CIPHERING RESPONSE message. The network starts ciphering when a valid AUTHENTICATION AND CIPHERING RESPONSE is received from the MS.

In GSM, as an option, the network may decide to continue ciphering without sending an AUTHENTICATION AND CIPHERING REQUEST message after receiving a ROUTING AREA UPDATE REQUEST message with a valid GPRS ciphering key sequence number. Both the MS and the network shall use the latest ciphering parameters. The network starts ciphering when sending the ciphered ROUTING AREA UPDATE ACCEPT message to the MS. The MS starts ciphering after receiving a valid ciphered ROUTING AREA UPDATE ACCEPT message from the network.

NOTE: In some specifications the term KSI (Key Set Identifier) is used instead of the term GPRS ciphering key sequence number.

#### 4.7.7.7 Use of established security contexts

In GSM, in the case of an established GSM security context, the GPRS GSM ciphering key shall be taken into use by the MS before the AUTHENTICATION AND CIPHERING RESPONSE message is transmitted.

#### 4.7.9.1 Paging for GPRS services

In GSM, paging is used by the network to identify the cell the MS has currently selected, or to prompt the mobile to re-attach if necessary as a result of network failure. If the MS is not GPRS attached when it receives a paging for GPRS services, the MS shall ignore the paging.

##### 4.7.9.1.1 Paging for GPRS services using P-TMSI

The network shall initiate the paging procedure for GPRS services using P-TMSI when GMM signalling messages or user data is pending to be sent to the MS while the Mobile Reachable timer is running. The network may page only GPRS MSs which are GMM-REGISTERED and identified by a local P-TMSI.

In GSM, to initiate the procedure the GMM entity requests the RR sublayer to start paging (see GSM 04.18, GSM 04.60), and starts timer T3313. Upon reception of a paging indication, the MS shall respond to the paging with any LLC frame (see 3GPP TS 24.007, 3GPP TS 23.060).

At intersystem change, an MS not having the READY timer running in GSM, being paged in a different access network as when it last sent user data or signalling message, uses ROUTING AREA UPDATE REQUEST message as paging response, i.e. the RA update procedure shall be performed instead according to the selective routing area update procedure.

The network shall stop timer T3313 when a response is received from the MS. When the timer T3313 expires the network may reinitiate paging.

In GSM, when a response is received from the MS, the network shall start the READY timer.

##### 4.7.9.1.2 Paging for GPRS services using IMSI

Paging for GPRS services using IMSI is an abnormal procedure used for error recovery in the network.

The network may initiate paging using IMSI if the P-TMSI is not available due to a network failure.

In GSM, to initiate the procedure the GMM entity in the network requests the RR sublayer to start paging (see GSM 04.18 and GSM 04.60).

Upon reception of a paging indication for GPRS services using IMSI, the MS shall locally deactivate any active PDP contexts and locally detach from GPRS. The local detach includes deleting any RAI, P-TMSI, P-TMSI signature and GPRS ciphering key sequence number stored, setting the GPRS update status to GU2 NOT UPDATED and changing state to GMM-DEREGISTERED.

After performing the local detach, the MS shall then perform a GPRS attach procedure.

After performing the attach, a MS should activate PDP context(s) to replace any previously active PDP context(s).

NOTE 1: In some cases, user interaction may be required and then the MS cannot activate the PDP context(s) automatically.

NOTE 2: The MS does not respond to the paging except with the Attach Request. Hence timer T3313 in the network is not used when paging with IMSI.

NOTE 3: Paging without DRX parameters may require a considerable extension of the paging duration.

#### 4.7.9.2 Paging for non-GPRS services

The network may initiate the paging procedure for non-GPRS services when the MS is IMSI attached for non-GPRS services.

In GSM, to initiate the procedure the GMM entity requests the RR sublayer to start paging (see GSM 04.18 and GSM 04.60) for non-GPRS services.

The MS identity used for paging shall be the allocated TMSI if acknowledged by the MS, otherwise the IMSI.

### 6.1.1 General

The main function of the session management (SM) is to support PDP context handling of the user terminal. The SM comprises procedures for identified PDP context activation, deactivation and modification. SM procedures for identified access can only be performed if a GMM context has been established between the MS and the network. If no GMM context has been established, the MM sublayer has to initiate the establishment of a GMM context by use of the GMM procedures as described in chapter 4. After GMM context establishment, SM uses services offered by GMM (see 3GPP TS 24.007). Ongoing SM procedures are suspended during GMM procedure execution.

For the session management protocol, the extended TI mechanism may be used (see 3GPP TS 24.007).

#### 6.1.3.1.1 Successful PDP context activation initiated by the mobile station

In order to request a PDP context activation, the MS sends an ACTIVATE PDP CONTEXT REQUEST message to the network, enters the state PDP-ACTIVE-PENDING and starts timer T3380. The message contains the selected NSAPI, PDP type, requested QoS and, if the MS requests a static address, the PDP address. The MS shall ensure that the selected NSAPI is not currently being used by another Session Management entity in the MS.

Upon receipt of an ACTIVATE PDP CONTEXT REQUEST message, the network selects a radio priority level based on the QoS negotiated and may reply with an ACTIVATE PDP CONTEXT ACCEPT message. Upon receipt of the message ACTIVATE PDP CONTEXT ACCEPT the MS shall stop timer T3380, shall enter the state PDP-ACTIVE. If the offered QoS parameters received from the network differ from the QoS requested by the MS, the MS shall either accept the negotiated QoS or initiate the PDP context deactivation procedure.

In GSM, the MS shall initiate establishment of the logical link for the LLC SAPI indicated by the network with the offered QoS and selected radio priority level if no logical link has been already established for that SAPI. If the offered QoS parameters received from the network differ from the QoS requested by the MS, the MS shall either accept the negotiated QoS or initiate the PDP context deactivation procedure. If the LLC SAPI indicated by the network cannot be supported by the MS, the MS shall initiate the PDP context deactivation procedure.

#### 6.1.3.2.1 Successful Secondary PDP Context Activation Procedure Initiated by the MS

In order to request a PDP context activation with the same PDP address and APN as an already active PDP context, the MS shall send an ACTIVATE SECONDARY PDP CONTEXT REQUEST message to the network, enter the state PDP-ACTIVE-PENDING and start timer T3380. The message shall contain the selected NSAPI. The MS shall ensure that the selected NSAPI is not currently being used by another Session Management entity in the MS. The message shall also include a QoS profile, a requested LLC SAPI and the Linked TI. The QoS profile is the requested QoS. If present, the TFT shall be sent transparently through the SGSN to the GGSN to enable packet classification and policing for downlink data transfer.

Upon receipt of an ACTIVATE SECONDARY PDP CONTEXT REQUEST, the network shall validate the message by verifying the TI given in the Linked TI IE to be any of the active PDP context(s). The same GGSN address shall be used by the SGSN as for the already established PDP context(s) for that PDP address. The network shall select a radio priority level based on the QoS negotiated and shall reply with an ACTIVATE SECONDARY PDP CONTEXT ACCEPT message, if the request can be accepted.

Upon receipt of the message ACTIVATE SECONDARY PDP CONTEXT ACCEPT, the MS shall stop timer T3380 and enter the state PDP-ACTIVE. If the offered QoS parameters received from the network differ from the QoS requested by the MS, the MS shall either accept the negotiated QoS or initiate the PDP context deactivation procedure.

In GSM the MS shall initiate establishment of the logical link for the LLC SAPI indicated by the network with the offered QoS and selected radio priority level if no logical link has been already established for that SAPI. If the LLC SAPI indicated by the network cannot be supported by the MS, the MS shall initiate the PDP context deactivation procedure.

#### 6.1.3.3.1 Network initiated PDP Context Modification

In order to initiate the procedure, the network sends the MODIFY PDP CONTEXT REQUEST message to the MS and starts timer T3386. The message shall contain the new QoS and the radio priority level and LLC SAPI that shall be used by the MS in GSM at the lower layers for the transmission of data related to the PDP context.

Upon receipt of this message the MS shall reply with the MODIFY PDP CONTEXT ACCEPT message, if the MS accepts the new QoS and the indicated LLC SAPI.

If the MS does not accept the new QoS or the indicated LLC SAPI, the MS shall initiate the PDP context deactivation procedure for the PDP context - the reject cause IE value of the DEACTIVATE PDP CONTEXT REQUEST message shall indicate "QoS not accepted".

The network shall upon receipt of the MODIFY PDP CONTEXT ACCEPT message stop timer T3386.

In GSM, the network shall establish, reconfigure or continue using the logical link with the new QoS for the LLC SAPI indicated in the MODIFY PDP CONTEXT REQUEST message.

#### 6.1.3.4.1 PDP context deactivation initiated by the MS

In order to deactivate a PDP context, the MS sends a DEACTIVATE PDP CONTEXT REQUEST message to the network, enters the state PDP-IN/ACTIVE-PENDING and starts timer T3390. The message contains the transaction identifier (TI) in use for the PDP context to be deactivated and a cause code that typically indicates one of the following causes:

- # 25: LLC or SNDTCP failure(GSM only);
- # 26: insufficient resources;
- # 36: regular PDP context deactivation; or
- # 37: QoS not accepted.

The network shall reply with the DEACTIVATE PDP CONTEXT ACCEPT message. Upon receipt of the DEACTIVATE PDP CONTEXT ACCEPT message, the MS shall stop timer T3390. In GSM, both the MS and the network shall initiate local release of the logical link if it is not used by another PDP context.

#### 6.1.3.4.2 PDP context deactivation initiated by the network

In order to deactivate a PDP context, the network sends a DEACTIVATE PDP CONTEXT REQUEST message to the MS and starts timer T3395. The message contains the transaction identifier in use for the PDP context to be deactivated and a cause code that typically indicates one of the following causes:

- # 25: LLC or SMDCP failure (GSM only);
- # 36: regular PDP context deactivation;
- # 38: network failure; or
- # 39: reactivation requested.

The MS shall, upon receipt of this message, reply with a DEACTIVATE PDP CONTEXT ACCEPT message. Upon receipt of the DEACTIVATE PDP CONTEXT ACCEPT message, the network shall stop the timer T3395. In GSM, both the MS and the network shall initiate local release of the logical link if it is not used by another PDP context.

## 8.1 General

The procedures specified in 3GPP TS 24.008 apply to those messages which pass the checks described in this clause.

This clause also specifies procedures for the handling of unknown, unforeseen, and erroneous protocol data by the receiving entity. These procedures are called "error handling procedures", but in addition to providing recovery mechanisms for error situations they define a compatibility mechanism for future extensions of the protocols.

Clauses 8.1 to 8.8 shall be applied in order of precedence.

Most error handling procedures are mandatory for the mobile station.

Detailed error handling procedures in the network are implementation dependent and may vary from PLMN to PLMN. However, when extensions of this protocol are developed, networks will be assumed to have the error handling that is indicated in this clause as mandatory ("shall") and that is indicated as strongly recommended ("should"). Clauses 8.2, 8.3, 8.4, 8.5 and 8.7.2 do not apply to the error handling in the network applied to the receipt of initial layer 3 message: If the network diagnoses an error described in one of these clauses in the initial layer 3 message received from the mobile station, it shall either:

- try to recognize the classmark and then take further implementation dependent actions; or
- release the RR-connection.

Also, the error handling of the network is only considered as mandatory or strongly recommended when certain thresholds for errors are not reached during a dedicated connection.

In this clause the following terminology is used:

- An IE is defined to be syntactically incorrect in a message if it contains at least one value defined as "reserved" in clause 10, or if its value part violates rules of clause 10. However it is not a syntactical error that a type 4 IE specifies in its length indicator a greater length than defined in clause 10.
- A message is defined to have semantically incorrect contents if it contains information which, possibly dependent on the state of the receiver, is in contradiction to the resources of the receiver and/or to the procedural part (i.e. clauses 3, 4 and 5) of 3GPP TS 24.008, 3GPP TS 24.010, or relevant GSM 04.8X series.

## 8.4 Unknown or unforeseen message type

If a mobile station receives an RR, MM message with message type not defined for the PD or not implemented by the receiver in unacknowledged mode, it shall ignore the message.

If a mobile station receives an RR, MM message with message type not defined for the PD or not implemented by the receiver in acknowledged mode, it shall return a status message (MM STATUS) with cause # 97 "message type non-existent or not implemented".

If a mobile station receives a CC message it shall ignore the message.

If a mobile station receives a GMM message or SM message with message type not defined for the PD or not implemented by the receiver, it shall return a status message (GMM STATUS or SM STATUS depending on the protocol discriminator) with cause # 97 "message type non-existent or not implemented".

If the network receives an MM message with message type not defined for the PD or not implemented by the receiver in a protocol state where reception of an unsolicited message with the given PD from the mobile station is not foreseen in the protocol, the network actions are implementation dependent. Otherwise, if the network receives a message with message type not defined for the PD or not implemented by the receiver, it shall ignore the message except that it should return a status message ( MM STATUS, GMM STATUS or SM STATUS depending on the protocol discriminator) with cause #97 "message type non-existent or not implemented".

If the network receives a CC message it shall ignore the message.

NOTE 1: A message type not defined for the PD in the given direction is regarded by the receiver as a message type not defined for the PD, see 3GPP TS 24.007.

If the mobile station receives a message not compatible with the protocol state, the mobile station shall ignore the message except for the fact that, if an RR connection exists, it returns a status message (MM STATUS) with cause #98 "Message type not compatible with protocol state". When the message was a GMM message the GMM-STATUS message with cause #98 "Message type not compatible with protocol state" shall be returned. When the message was a SM message the SM-STATUS message with cause #98 "Message type not compatible with protocol state" shall be returned.

If the network receives a message not compatible with the protocol state, the network actions are implementation dependent.

NOTE 2: The use by GMM and SM of unacknowledged LLC may lead to messages "not compatible with the protocol state".

## 8.5 Non-semantic mandatory information element errors

When on receipt of a message,

- an "imperative message part" error; or
- a "missing mandatory IE" error

is diagnosed or when a message containing:

- a syntactically incorrect mandatory IE; or
- an IE unknown in the message, but encoded as "comprehension required" (see GSM 04.07); or
- an out of sequence IE encoded as "comprehension required" (see GSM 04.07)

is received,

- the mobile station shall proceed as follows:

If the message is not one of the messages listed in clauses 8.5.1, 8.5.2, 8.5.3, 8.5.4 and 8.5.5 a) or b), the mobile station shall ignore the message except for the fact that, if an RR connection exists, it shall return a status message (MM STATUS depending on the protocol discriminator) with cause # 96 "Invalid mandatory information". If the message was a GMM message the GMM-STATUS message with cause #96 " Invalid mandatory information" shall be returned. If the message was an SM message the SM-STATUS message with cause # 96 "invalid mandatory information" shall be returned.

- the network shall proceed as follows:

When the message is not one of the messages listed in clause 8.5.3 b), c), d) or e) and 8.5.5 a) or c), the network shall either:

- try to treat the message (the exact further actions are implementation dependent); or

- ignore the message except that it should return a status message ( MM STATUS (depending on the protocol discriminator), GMM STATUS, or SM STATUS) with cause # 96 "Invalid mandatory information".

### 8.7.2 Conditional IE errors

When the MS upon receipt of an RR, MM message diagnoses a "missing conditional IE" error or an "unexpected conditional IE" error or when it receives an RR, MM message containing at least one syntactically incorrect conditional IE, it shall ignore the message except for the fact that, if an RR connection exists, it shall return a status message (MM STATUS depending on the PD) with cause value # 100 "conditional IE error".

When the MS upon receipt of a GMM or SM message diagnoses a "missing conditional IE" error or an "unexpected conditional IE" error or when it receives a GMM or SM message containing at least one syntactically incorrect conditional IE, it shall ignore the message and it shall return a status message (GMM STATUS or SM STATUS depending on the PD) with cause value # 100 "conditional IE error".

When the network receives a message and diagnose a "missing conditional IE" error or an "unexpected conditional IE" error or when it receives a message containing at least one syntactically incorrect conditional IE, the network shall either:

- try to treat the message (the exact further actions are implementation dependent); or
- ignore the message except that it should return a status message ( MM STATUS, GMM STATUS or SM STATUS depending on the protocol discriminator) with cause # 100 "conditional IE error".

## 8.8 Messages with semantically incorrect contents

When a message with semantically incorrect contents is received, the foreseen reactions of the procedural part of 3GPP TS 24.008 (i.e. clauses 3, 4 and 5) are performed. If however no such reactions are specified, the MS shall ignore the message except for the fact that, if an RR connection exists, it returns a status message (MM STATUS depending on the PD) with cause value # 95 "semantically incorrect message".

The network should follow the same procedure except that a status message is not normally transmitted.

---

## 9 Message functional definitions and contents

This clause defines the structure of the messages of those layer 3 protocols defined in 3GPP TS 24.008. These are standard L3 messages as defined in 3GPP TS 24.007.

Each definition given in the present clause includes:

- a) a brief description of the message direction and use, including whether the message has:
  - 1) Local significance, i.e. relevant only on the originating or terminating access;
  - 2) Access significance, i.e. relevant in the originating and terminating access, but not in the network;
  - 3) Dual significance, i.e. relevant in either the originating or terminating access and in the network; or
  - 4) Global significance, i.e. relevant in the originating and terminating access and in the network.
- b) a table listing the information elements known in the message and their order of their appearance in the message. All information elements that may be repeated are explicitly indicated. ( V and LV formatted IEs, which compose the imperative part of the message, occur before T, TV, and TLV formatted IEs which compose the non-imperative part of the message, see 3GPP TS 24.007.) In a (maximal) sequence of consecutive information elements with half octet length, the first information element with half octet length occupies bits 1 to 4 of octet N, the second bits 5 to 8 of octet N, the third bits 1 to 4 of octet N+1 etc. Such a sequence always has an even number of elements.

For each information element the table indicates:

- 1) the information element identifier, in hexadecimal notation, if the IE has format T, TV, or TLV. Usually, there is a default IEI for an information element type; default IEIs of different IE types of the same protocol are different. If the IEI has half octet length, it is specified by a notation representing the IEI as a hexadecimal digit followed by a "-" (example: B-).

NOTE: The same IEI may be used for different information element types in different messages of the same protocol.

- 2) the name of the information element (which may give an idea of the semantics of the element). The name of the information element (usually written in italics) followed by "IE" or "information element" is used in 3GPP TS 24.008 as reference to the information element within a message.
- 3) the name of the type of the information element (which indicates the coding of the value part of the IE), and generally, the referenced subclause of clause 10 of 3GPP TS 24.008 describing the value part of the information element.
- 4) the presence requirement indication (M, C, or O) for the IE as defined in 3GPP TS 24.007.
- 5) the format of the information element (T, V, TV, LV, TLV) as defined in 3GPP TS 24.007.
- 6) the length of the information element (or permissible range of lengths), in octets, in the message, where "?" means that the maximum length of the IE is only constrained by link layer protocol, and in the case of the Facility IE by possible further conditions specified in 3GPP TS 24.010. This indication is non-normative.

Subsections specifying, where appropriate, conditions for IEs with presence requirement C or O in the relevant message which together with other conditions specified in 3GPP TS 24.008 define when the information elements shall be included or not, what non-presence of such IEs means, and - for IEs with presence requirement C - the static conditions for presence and/or non-presence of the IEs (see 3GPP TS 24.007).

Any information elements specific to 3G, UMTS, UTRAN, CDMA2000, VGCS, VBS, Dual Transfer Mode, Group Receive Mode or Group Transmit Mode shall not be included within any message.

In the case where CSN1 is used to describe the structure of a message, any 3G, UMTS, UTRAN, CDMA2000, VGCS, VBS, Dual Transfer Mode, Group Receive Mode or Group Transmit Mode struct or bit shall not be included within any message, or shall be given a value that indicates that these features are not supported.



## 9.2.2 Authentication request

This message is sent by the network to the mobile station to initiate authentication of the mobile station identity. See table 9.2.3/3GPP TS 24.008.

Message type: AUTHENTICATION REQUEST

Significance: dual

Direction: network to mobile station

**Table 9.2.3/3GPP TS 24.008: AUTHENTICATION REQUEST message content**

IEI	Information element	Type/Reference	Presence	Format	Length
	Mobility management protocol discriminator	Protocol discriminator 10.2	M	V	1/2
	Skip Indicator	Skip Indicator 10.3.1	M	V	1/2
	Authentication Request message type	Message type 10.4	M	V	1
	Ciphering key sequence number	Ciphering key sequence number 10.5.1.2	M	V	1/2
	Spare half octet	Spare half octet 10.5.1.8	M	V	1/2
	Authentication parameter RAND (UMTS challenge or GSM challenge)	Auth. parameter RAND 10.5.3.1	M	V	16

## 9.2.3 Authentication response

This message is sent by the mobile station to the network to deliver a calculated response to the network. See table 9.2.4/3GPP TS 24.008.

Message type: AUTHENTICATION RESPONSE

Significance: dual

Direction: mobile station to network

**Table 9.2.4/3GPP TS 24.008: AUTHENTICATION RESPONSE message content**

IEI	Information element	Type/Reference	Presence	Format	Length
	Mobility management protocol discriminator	Protocol discriminator 10.2	M	V	1/2
	Skip Indicator	Skip Indicator 10.3.1	M	V	1/2
	Authentication Response message type	Message type 10.4	M	V	1
	Authentication Response parameter	Auth. Response parameter 10.5.3.2	M	V	4

## 9.2.9 CM service request

This message is sent by the mobile station to the network to request a service for the connection management sublayer entities, e.g. circuit switched connection establishment, supplementary services activation, short message transfer, location services. See table 9.2.11/3GPP TS 24.008.

Message type: CM SERVICE REQUEST

Significance: dual

Direction: mobile station to network

**Table 9.2.11/3GPP TS 24.008: CM SERVICE REQUEST message content**

IEI	Information element	Type/Reference	Presence	Format	Length
	Mobility management protocol discriminator	Protocol discriminator 10.2	M	V	1/2
	Skip Indicator	Skip Indicator 10.3.1	M	V	1/2
	CM Service Request message type	Message type 10.4	M	V	1
	CM service type	CM service type 10.5.3.3	M	V	1/2
	Ciphering key sequence number	Ciphering key sequence number 10.5.1.2	M	V	1/2
	Mobile station classmark	Mobile station classmark 2 10.5.1.6	M	LV	4
	Mobile identity	Mobile identity 10.5.1.4	M	LV	2-9

## 9.2.15 Location updating request

This message is sent by the mobile station to the network either to request update of its location file (normal updating or periodic updating) or to request IMSI attach. See table 9.2.17/3GPP TS 24.008.

Message type: LOCATION UPDATING REQUEST

Significance: dual

Direction: mobile station to network

**Table 9.2.17/3GPP TS 24.008: LOCATION UPDATING REQUEST message content**

IEI	Information element	Type/Reference	Presence	Format	Length
	Mobility management protocol discriminator	Protocol discriminator 10.2	M	V	1/2
	Skip Indicator	Skip Indicator 10.3.1	M	V	1/2
	Location Updating Request message type	Message type 10.4	M	V	1
	Location updating type	Location updating type 10.5.3.5	M	V	1/2
	Ciphering key sequence number	Ciphering key sequence number 10.5.1.2	M	V	1/2
	Location area identification	Location area identification 10.5.1.3	M	V	5
	Mobile station classmark	Mobile station classmark 1 10.5.1.5	M	V	1
	Mobile identity	Mobile identity 10.5.1.4	M	LV	2-9

## 9.4.9 Authentication and ciphering request

This message is sent by the network to the MS to initiate authentication of the MS identity. Additionally, the ciphering mode is set, indicating whether ciphering will be performed or not. See table 9.4.9/3GPP TS 24.008.

Message type: AUTHENTICATION AND CIPHERING REQUEST

Significance: dual

Direction: network to MS

**Table 9.4.9/3GPP TS 24.008: AUTHENTICATION AND CIPHERING REQUEST message content**

IEI	Information Element	Type/Reference	Presence	Format	Length
	Protocol discriminator	Protocol discriminator 10.2	M	V	1/2
	Skip indicator	Skip indicator 10.3.1	M	V	1/2
	Authentication and ciphering request message identity	Message type 10.4	M	V	1
	Ciphering algorithm	Ciphering algorithm 10.5.5.3	M	V	1/2
	IMEISV request	IMEISV request 10.5.5.10	M	V	1/2
	Force to standby	Force to standby 10.5.5.7	M	V	1/2
	A&C reference number	A&C reference number 10.5.5.19	M	V	1/2
21	Authentication parameter RAND	Authentication parameter RAND 10.5.3.1	O	TV	17
8	GPRS ciphering key sequence number	Ciphering key sequence number 10.5.1.2	C	TV	1

## 9.4.10 Authentication and ciphering response

This message is sent by the MS to the network in response to an *Authentication and ciphering request* message. See table 9.4.10/3GPP TS 24.008.

Message type: AUTHENTICATION AND CIPHERING RESPONSE

Significance: dual

Direction: MS to network

**Table 9.4.10/3GPP TS 24.008: AUTHENTICATION AND CIPHERING RESPONSE message content**

IEI	Information Element	Type/Reference	Presence	Format	Length
	Protocol discriminator	Protocol discriminator 10.2	M	V	1/2
	Skip indicator	Skip indicator 10.3.1	M	V	1/2
	Authentication and ciphering response message identity	GPRS message type 10.4	M	V	1
	A&C reference number	A&C reference number 10.5.5.19	M	V	1/2
	Spare half octet	Spare half octet 10.5.1.8	M	V	1/2
22	Authentication parameter Response	Authentication Response parameter 10.5.3.2	O	TV	5
23	IMEISV	Mobile identity 10.5.1.4	O	TLV	11

### 9.4.10.1 Authentication Response Parameter

This IE is included if authentication was requested within the corresponding *authentication and ciphering request* message. This IE contains the SRES, if the authentication challenge was for GSM.

## 10.1 Overview

Within the Layer 3 protocols defined in 3GPP TS 24.008, every message is a standard L3 message as defined in 3GPP TS 24.007. This means that the message consists of the following parts:

- a) protocol discriminator;
- b) transaction identifier;
- c) message type;
- d) other information elements, as required.

This organization is illustrated in the example shown in figure 10.1/3GPP TS 24.008.

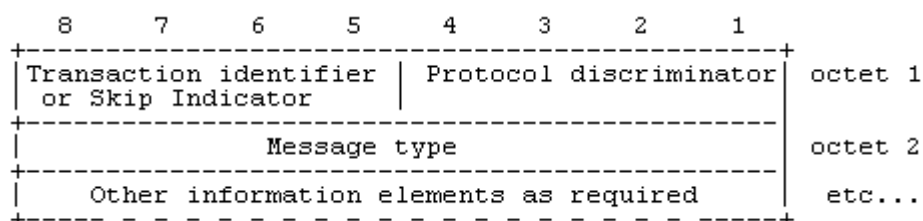

**Figure 10.1/3GPP TS 24.008 General message organization example**

Unless specified otherwise in the message descriptions of clause 9, a particular information element shall not be present more than once in a given message.

The term "default" implies that the value defined shall be used in the absence of any assignment, or that this value allows negotiation of alternative values in between the two peer entities.

When a field extends over more than one octet, the order of bit values progressively decreases as the octet number increases. The least significant bit of the field is represented by the lowest numbered bit of the highest numbered octet of the field.

Any 3G, UMTS, UTRAN, CDMA2000, VGCS, VBS, Dual Transfer Mode, Group Receive Mode or Group Transmit Mode fields shall not be included within any information element, or shall be given a value that indicates that these features are not supported.

### 10.3.2 Transaction identifier

Bits 5 to 8 of the first octet of every message belonging to the protocols "Session Management" contain the transaction identifier (TI). The transaction identifier and its use are defined in 3GPP TS 24.007.

For the session management protocol, the extended TI mechanism may be used (see 3GPP TS 24.007).

## 10.4 Message Type

The message type IE and its use are defined in 3GPP TS 24.007. Tables 10.3/3GPP TS 24.008, 10.4/3GPP TS 24.008, and 10.4a/3GPP TS 24.008 define the value part of the message type IE used in the Mobility Management protocol and Session management protocol.

**Table 10.2/3GPP TS 24.008: Message types for Mobility Management**

8	7	6	5	4	3	2	1	
x	x	0	0	-	-	-	-	Registration messages:
				0	0	0	1	- IMSI DETACH INDICATION
				0	0	1	0	- LOCATION UPDATING ACCEPT
				0	1	0	0	- LOCATION UPDATING REJECT
				1	0	0	0	- LOCATION UPDATING REQUEST
x	x	0	1	-	-	-	-	Security messages:
				0	0	0	1	- AUTHENTICATION REJECT
				0	0	1	0	- AUTHENTICATION REQUEST
				0	1	0	0	- AUTHENTICATION RESPONSE
				1	1	0	0	- AUTHENTICATION FAILURE.....
				1	0	0	0	- IDENTITY REQUEST
				1	0	0	1	- IDENTITY RESPONSE
				1	0	1	0	- TMSI REALLOCATION COMMAND
				1	0	1	1	- TMSI REALLOCATION COMPLETE
x	x	1	0	-	-	-	-	Connection management messages:
				0	0	0	1	- CM SERVICE ACCEPT
				0	0	1	0	- CM SERVICE REJECT
				0	0	1	1	- CM SERVICE ABORT
				0	1	0	0	- CM SERVICE REQUEST
				0	1	0	1	- CM SERVICE PROMPT
				0	1	1	0	- Reserved (see NOTE)
				1	0	0	0	- CM RE-ESTABLISHMENT REQUEST
				1	0	0	1	- ABORT
x	x	1	1	-	-	-	-	Miscellaneous messages:
				0	0	0	0	- MM NULL
				0	0	0	1	- MM STATUS
				0	0	1	0	- MM INFORMATION

NOTE: This value was allocated but never used in earlier phases of the protocol.

When the radio connection started with a core network node of earlier than R99, bit 8 shall be set to 0 and bit 7 is reserved for the send sequence number in messages sent from the mobile station. In messages sent from the network, bits 7 and 8 are coded with a "0". See 3GPP TS 24.007.

When the radio connection started with a core network node of R'99 or later, bits 7 and 8 are reserved for the send sequence number in messages sent from the mobile station. In messages sent from the network, bits 7 and 8 are coded with a "0". See 3GPP TS 24.007.

When the radio connection started with a core network node of earlier than R99, bit 8 shall be set to 0 and bit 7 is reserved for the send sequence number in messages sent from the mobile station. In messages sent from the network, bits 7 and 8 are coded with a "0". See 3GPP TS 24.007.

When the radio connection started with a core network node of R'99 or later, bits 7 and 8 are reserved for the send sequence number in messages sent from the mobile station. In messages sent from the network, bits 7 and 8 are coded with a "0". See 3GPP TS 24.007.

Table 10.4/3GPP TS 24.008: Message types for GPRS mobility management

Bits								
8	7	6	5	4	3	2	1	
0	0	-	-	-	-	-	-	Mobility management messages
0	0	0	0	0	0	0	1	Attach request
0	0	0	0	0	0	1	0	Attach accept
0	0	0	0	0	0	1	1	Attach complete
0	0	0	0	0	1	0	0	Attach reject
0	0	0	0	0	1	0	1	Detach request
0	0	0	0	0	1	1	0	Detach accept
0	0	0	0	1	0	0	0	Routing area update request
0	0	0	0	1	0	0	1	Routing area update accept
0	0	0	0	1	0	1	0	Routing area update complete
0	0	0	0	1	0	1	1	Routing area update reject
0	0	0	0	1	1	0	0	Service Request
0	0	0	0	1	1	0	1	Service Accept
0	0	0	0	1	1	1	0	Service Reject
0	0	0	1	0	0	0	0	P-TMSI reallocation command
0	0	0	1	0	0	0	1	P-TMSI reallocation complete
0	0	0	1	0	0	1	0	Authentication and ciphering req
0	0	0	1	0	0	1	1	Authentication and ciphering resp
0	0	0	1	0	1	0	0	Authentication and ciphering rej
0	0	0	1	1	1	0	0	Authentication and ciphering failure
0	0	0	1	0	1	0	1	Identity request
0	0	0	1	0	1	1	0	Identity response
0	0	1	0	0	0	0	0	GMM status
0	0	1	0	0	0	0	1	GMM information

**Table 10.4a/3GPP TS 24.008: Message types for GPRS session management**

Bits								
8	7	6	5	4	3	2	1	
0	1	-	-	-	-	-	-	Session management messages
0	1	0	0	0	0	0	1	Activate PDP context request
0	1	0	0	0	0	1	0	Activate PDP context accept
0	1	0	0	0	0	1	1	Activate PDP context reject
0	1	0	0	0	1	0	0	Request PDP context activation
0	1	0	0	0	1	0	1	Request PDP context activation rej.
0	1	0	0	0	1	1	0	Deactivate PDP context request
0	1	0	0	0	1	1	1	Deactivate PDP context accept
0	1	0	0	1	0	0	0	Modify PDP context request(Network to MS direction)
0	1	0	0	1	0	0	1	Modify PDP context accept (MS to network direction)
0	1	0	0	1	0	1	0	Modify PDP context request(MS to network direction)
0	1	0	0	1	0	1	1	Modify PDP context accept (Network to MS direction)
0	1	0	0	1	1	0	0	Modify PDP context reject
0	1	0	0	1	1	0	1	Activate secondary PDP context request
0	1	0	0	1	1	1	0	Activate secondary PDP context accept
0	1	0	0	1	1	1	1	Activate secondary PDP context reject
0	1	0	1	0	0	0	0	Reserved: was allocated in earlier phases of the protocol
0	1	0	1	0	0	0	1	Reserved: was allocated in earlier phases of the protocol
0	1	0	1	0	0	1	0	Reserved: was allocated in earlier phases of the protocol
0	1	0	1	0	0	1	1	Reserved: was allocated in earlier phases of the protocol
0	1	0	1	0	1	0	0	Reserved: was allocated in earlier phases of the protocol
0	1	0	1	0	1	0	1	SM Status

## 10.5 Other information elements

The different formats (V, LV, T, TV, TLV) and the four categories of information elements (type 1, 2, 3, and 4) are defined in 3GPP TS 24.007.

The first octet of an information element in the non-imperative part contains the IEI of the information element. If this octet does not correspond to an IEI known in the message, the receiver shall determine whether this IE is of type 1 or 2 (i.e. it is an information element of one octet length) or an IE of type 4 (i.e. that the next octet is the length indicator indicating the length of the remaining of the information element) (see 3GPP TS 24.007).

This allows the receiver to jump over unknown information elements and to analyse any following information elements.

The information elements which are common for at least two of the three protocols Radio Resources management, Mobility Management, are listed in clause 10.5.1.

The information elements for the protocols Mobility Management are listed in clauses 10.5.3 and 10.5.4 respectively. Default information element identifiers are listed in annex K.

**NOTE:** Different information elements may have the same default information element identifier if they belong to different protocols.

The descriptions of the information element types in clauses 10.5.1, 10.5.3, and 10.5.4 are organized in alphabetical order of the IE types. Each IE type is described in one subsection.

The subsection may have an introduction:

- possibly explaining the purpose of the IE;
- possibly describing whether the IE belongs to type 1, 2, 3, 4 or 5;

- possibly indicating the length that the information element has if it is either type 5 or if it is used in format TV (type 1 and 3) or TLV (type 4).

A figure of the subsection defines the structure of the IE indicating:

- possibly the position and length of the IEI (However it depends on the message in which the IE occurs whether the IE contains an IEI.);
- the fields the IE value part is composed of;
- possibly the position and length of the length indicator (However it depends on the IE type whether the IE contains a length indicator or not.);
- possibly octet numbers of the octets that compose the IE (see clause a) below).

Finally, the subsection contains tables defining the structure and value range of the fields that compose the IE value part. The order of appearance for information elements in a message is defined in clause 9.

The order of the information elements within the imperative part of messages has been chosen so that information elements with 1/2 octet of content (type 1) go together in succession. The first type 1 information element occupies bits 1 to 4 of octet N, the second bits 5 to 8 of octet N, the third bits 1 to 4 of octet N + 1 etc. If the number of type 1 information elements is odd then bits 5 to 8 of the last octet occupied by these information elements contains a spare half octet IE in format V.

Where the description of information elements in the present document contains bits defined to be "spare bits", these bits shall set to the indicated value (0 or 1) by the sending side, and their value shall be ignored by the receiving side. With few exceptions, spare bits are indicated as being set to "0" in 3GPP TS 24.008.

The following rules apply for the coding of type 4 information elements:

- The octet number of an octet (which is defined in the figure of a subsection) consists of a positive integer, possibly of an additional letter, and possibly of an additional asterisk, see clause f). The positive integer identifies one octet or a group of octets.
- Each octet group is a self contained entity. The internal structure of an octet group may be defined in alternative ways.
- An octet group is formed by using some extension mechanism. The preferred extension mechanism is to extend an octet (N) through the next octet(s) (Na, Nb, etc.) by using bit 8 in each octet as an extension bit.

The bit value "0" indicates that the octet group continues through to the next octet. The bit value "1" indicates that this octet is the last octet of the group. If one octet (Nb) is present, the preceding octets (N and Na) shall also be present.

In the format descriptions appearing in clause 10.5.1 to 10.5.4, bit 8 is marked "0/1 ext" if another octet follows. Bit 8 is marked "1 ext" if this is the last octet in the extension domain.

Additional octets may be defined in later versions of the protocols ("1 ext" changed to "0/1 ext") and equipments shall be prepared to receive such additional octets; the contents of these octets shall be ignored. However the length indicated in clauses 9 and 10 only takes into account this version of the protocols.

- In addition to the extension mechanism defined above, an octet (N) may be extended through the next octet(s) (N+1, N+2 etc.) by indications in bits 7-1 (of octet N).
- The mechanisms in c) and d) may be combined.
- Optional octets are marked with asterisks (\*).

#### 10.5.1.4 Mobile Identity

The purpose of the *Mobile Identity* information element is to provide either the international mobile subscriber identity, IMSI, the temporary mobile subscriber identity, TMSI/P-TMSI, the international mobile equipment identity, IMEI or the international mobile equipment identity together with the software version number, IMEISV.



The IMSI shall not exceed 15 digits, the TMSI/P-TMSI is 4 octets long, and the IMEI is composed of 15 digits, the IMEISV is 16 digits (see 3GPP TS 23.003).

For packet paging the network shall select the mobile identity type with the following priority:

- 1) P-TMSI: The P-TMSI shall be used if it is available.
- 2) IMSI: The IMSI shall be used in cases where no P-TMSI is available.

For all other transactions except mobile terminated call establishment, the identification procedure, the GMM identification procedure, the GMM authentication and ciphering procedure and the ciphering mode setting procedure, the mobile station and the network shall select the mobile identity type with the following priority:

- 1) TMSI: The TMSI shall be used if it is available.
- 2) IMSI: The IMSI shall be used in cases where no TMSI is available.

For mobile terminated call establishment the mobile station shall select the same mobile identity type as received from the network in the PAGING REQUEST message.

In the identification procedure and in the GMM identification procedure the mobile station shall select the mobile identity type which was requested by the network.

In the ciphering mode setting procedure and in the GMM authentication and ciphering procedure the mobile shall select the IMEISV.

The *Mobile Identity* information element is coded as shown in figure 10.5.4/3GPP TS 24.008 and table 10.5.4/3GPP TS 24.008.

The *Mobile Identity* is a type 4 information element with a minimum length of 3 octet and 11 octets length maximal. Further restriction on the length may be applied, e.g. number plans.

8	7	6	5	4	3	2	1	
Mobile Identity IEI								octet 1
Length of mobile identity contents								octet 2
Identity digit 1				odd/ even indic	Type of identity			octet 3
Identity digit p+1				Identity digit p				octet 4*

**Figure 10.5.4/3GPP TS 24.008 *Mobile Identity* information element**

**Table 10.5.4/3GPP TS 24.008: Mobile Identity information element**

Type of identity (octet 3)			
Bits			
<b>3</b>	<b>2</b>	<b>1</b>	
0	0	1	IMSI
0	1	0	IMEI
0	1	1	IMEISV
1	0	0	TMSI/P-TMSI
0	0	0	No Identity note 1)
All other values are reserved.			
Odd/even indication (octet 3)			
Bit			
<b>4</b>			
0	even number of identity digits and also when the TMSI/P-TMSI is used		
1	odd number of identity digits		
Identity digits (octet 3 etc)			
For the IMSI, IMEI and IMEISV this field is coded using BCD coding. If the number of identity digits is even then bits 5 to 8 of the last octet shall be filled with an end mark coded as "1111".			
If the mobile identity is the TMSI/P-TMSI then bits 5 to 8 of octet 3 are coded as "1111" and bit 8 of octet4 is the most significant bit and bit 1 of the last octet the least significant bit. The coding of the TMSI/P-TMSI is left open for each administration.			

NOTE: This can be used in the case when a fill paging message without any valid identity has to be sent on the paging subchannel.

### 10.5.1.6 Mobile Station Classmark 2

The purpose of the *Mobile Station Classmark 2* information element is to provide the network with information concerning aspects of both high and low priority of the mobile station equipment. This affects the manner in which the network handles the operation of the mobile station. The Mobile Station Classmark information indicates general mobile station characteristics and it shall therefore, except for fields explicitly indicated, be independent of the frequency band of the channel it is sent on.

The *Mobile Station Classmark 2* information element is coded as shown in figure 10.5.6/3GPP TS 24.008, table 10.5.6a/3GPP TS 24.008 and table 10.5.6b/3GPP TS 24.008.

The *Mobile Station Classmark 2* is a type 4 information element with 5 octets length.

8	7	6	5	4	3	2	1	
Mobile station classmark 2 IEI								octet 1
Length of mobile station classmark 2 contents								octet 2
0 spare	Revision level		ES IND	A5/1	RF power capability			octet 3
0 spare	PS capability	SS Screen. Indicator	SM capability	VBS	VGCS	FC		octet 4
CM3	0 spare	LCSV A CAP	UCS2	SoLSA	CMS P	A5/3	A5/2	octet 5

NOTE: Owing to backward compatibility problems, bit 8 of octet 4 should not be used unless it is also checked that the bits 8, 7 and 6 of octet 3 are not "0 0 0".

**Figure 10.5.6/3GPP TS 24.008 Mobile Station Classmark 2 information element**

**Table 10.5.6a/3GPP TS 24.008: Mobile Station Classmark 2 information element**

<b>Revision level</b> (octet 3) Required for MS supporting GSM and UMTS. Bits	
<b>7 6</b>	
0 0	Reserved for GSM phase 1
0 1	Used by GSM phase 2 mobile stations
1 0	Used by mobile stations supporting this version of the protocol
1 1	Reserved for future use
<b>ES IND</b> (octet 3, bit 5) "Controlled Early Classmark Sending" option implementation Required for MS supporting GSM.	
0	"Controlled Early Classmark Sending" option is not implemented in the MS
1	"Controlled Early Classmark Sending" option is implemented in the MS
NOTE: The value of the ES IND gives the implementation in the MS. It's value is <b>not</b> dependent on the broadcast SI 3 Rest Octet <Early Classmark Sending Control> value	
<b>A5/1</b> algorithm supported (octet 3, bit 4) Required for MS supporting GSM.	
0	encryption algorithm A5/1 available
1	encryption algorithm A5/1 not available
<b>RF Power Capability</b> (Octet 3) Required for MS supporting GSM. When GSM 450, GSM 480, GSM 850, GSM 900 P, E [or R] or TETRA 380, TETRA 410, TETRA 450, TETRA 870 is used (for exceptions see GSM 04.18): Bits	
<b>3 2 1</b>	
0 0 0	class 1
0 0 1	class 2
0 1 0	class 3
0 1 1	class 4
1 0 0	class 5
All other values are reserved.	
When the DCS 1800 or PCS 1900 band is used (for exceptions see 3): Bits	
<b>3 2 1</b>	
0 0 0	class 1
0 0 1	class 2
0 1 0	class 3
All other values are reserved.	
<b>PS capability</b> (pseudo-synchronization capability) (octet 4) Required for MS supporting GSM Bit 7	
0	PS capability not present
1	PS capability present
<b>SS Screening Indicator</b> (octet 4) Required for MS supporting GSM and UMTS Bits	
<b>6 5</b>	
0 0	defined in 3GPP TS 24.080
0 1	defined in 3GPP TS 24.080
1 0	defined in 3GPP TS 24.080
1 1	defined in 3GPP TS 24.080
<b>SM capability</b> (MT SMS pt to pt capability) (octet 4) Required for MS supporting GSM. Bit 4	
0	Mobile station does not support mobile terminated point to point SMS
1	Mobile station supports mobile terminated point to point SMS

Table 10.5.6a/3GPP TS 24.008: *Mobile Station Classmark 2* information element

**VBS notification reception** (octet 4)

Required for MS supporting GSM.

**Bit 3**

- 0 No VBS capability or no notifications wanted
- 1 VBS capability and notifications wanted

**VGCS notification reception** (octet 4)

Required for MS supporting GSM.

**Bit 2**

- 0 no VGCS capability or no notifications wanted
- 1 VGCS capability and notifications wanted

**FC Frequency Capability** (octet 4)

Required for MS supporting GSM.

When GSM 400 band is used (for exceptions see GSM 04.18):

**Bit 1**

- 0 Reserved for future use (for definition of frequency bands see GSM 05.05)

NOTE: This bit conveys no information about support or non support of the E-GSM or R-GSM band when transmitted on a GSM 400 channel.

When GSM 850 band is used (for exceptions see GSM 04.18):

**Bit 1**

- 0 Reserved for future use (for definition of frequency bands see GSM 05.05)

NOTE: This bit conveys no information about support or non support of the E-GSM or R-GSM band when transmitted on a GSM 850 channel.

When a GSM 900 band is used (for exceptions see GSM 04.18):

**Bit 1**

- 0 The MS does not support the E-GSM or R-GSM band (For definition of frequency bands see GSM 05.05)
- 1 The MS does support the E-GSM or R-GSM (For definition of frequency bands see GSM 05.05)

NOTE: For mobile station supporting the R-GSM band further information can be found in MS Classmark 3.

When the DCS 1800 band is used (for exceptions see GSM 04.18):

**Bit 1**

- 0 Reserved for future use (for definition of frequency bands see GSM 05.05)

NOTE: This bit conveys no information about support or non support of the E-GSM or R-GSM band when transmitted on a DCS 1800 channel.

When the PCS 1900 band is used (for exceptions see GSM 04.18):

**Bit 1**

- 0 Reserved for future use (for definition of frequency bands see GSM 05.05)

NOTE: This bit conveys no information about support or non support of the E-GSM or R-GSM band when transmitted on a PCS 1900 channel.

When the TETRA 380 band is used:

**Bit 1**

- 0 Reserved for future use (for definition of frequency bands see GSM 05.05)

NOTE: This bit conveys no information about support or non support of the E-GSM or R-GSM band when transmitted on a TETRA 380 channel.

When the TETRA 410 band is used:

**Bit 1**

- 0 Reserved for future use (for definition of frequency bands see GSM 05.05)

NOTE: This bit conveys no information about support or non support of the E-GSM or R-GSM band when transmitted on a TETRA 410 channel.

When the TETRA 450 band is used:	
<b>Bit 1</b>	
0	Reserved for future use (for definition of frequency bands see GSM 05.05)
<b>NOTE:</b> This bit conveys no information about support or non support of the E-GSM or R-GSM band when transmitted on a TETRA 450 channel.	
When the TETRA 870 band is used:	
<b>Bit 1</b>	
0	Reserved for future use (for definition of frequency bands see GSM 05.05)
<b>NOTE:</b> This bit conveys no information about support or non support of the E-GSM or R-GSM band when transmitted on a TETRA 870 channel.	
<b>CM3</b> (octet 5, bit 8)	
Required for MS supporting GSM.	
0	The MS does not support any options that are indicated in CM3
1	The MS supports options that are indicated in classmark 3 IE
<b>LCS VA capability</b> (LCS value added location request notification capability) (octet 5, bit 6)	
Required for MS supporting GSM.	
0	LCS value added location request notification capability not supported
1	LCS value added location request notification capability supported
<b>UCS2 treatment</b> (octet 5, bit 5)	
Required for MS supporting UMTS.	
This information field indicates the likely treatment by the mobile station of UCS2 encoded character strings. If not included, the value 0 shall be assumed by the receiver.	
0	the ME has a preference for the default alphabet (defined in GSM 03.38) over UCS2.
1	the ME has no preference between the use of the default alphabet and the use of UCS2.
<b>SoLSA</b> (octet 5, bit 4)	
Required for MS supporting GSM.	
0	The ME does not support SoLSA.
1	The ME supports SoLSA.
<b>CMSP: CM Service Prompt</b> (octet 5, bit 3) \$(CCBS)\$	
Required for MS supporting GSM and UMTS.	
0	"Network initiated MO CM connection request" not supported.
1	"Network initiated MO CM connection request" supported for at least one CM protocol.
<b>A5/3 algorithm supported</b> (octet 5, bit 2)	
Required for MS supporting GSM.	
0	encryption algorithm A5/3 not available
1	encryption algorithm A5/3 available
<b>A5/2 algorithm supported</b> (octet 5, bit 1)	
Required for MS supporting GSM.	
0	encryption algorithm A5/2 not available
1	encryption algorithm A5/2 available

A MS supporting GSM shall always encode all fields relevant for GSM radio access technology, even when accessing UMTS radio access technology. A UMTS MS which does not support GSM shall encode fields relevant only for GSM radio access technology using any value which has been defined for this version of the protocol and is not reserved.

**NOTE:** Additional mobile station capability information might be obtained by invoking the classmark interrogation procedure when the mobile station is accessing the GSM radio access technology.

### 10.5.1.7 Mobile Station Classmark 3

The purpose of the *Mobile Station Classmark 3* information element is to provide the network with information concerning aspects of the mobile station. The contents might affect the manner in which the network handles the operation of the mobile station. The Mobile Station Classmark information indicates general mobile station characteristics and it shall therefore, except for fields explicitly indicated, be independent of the frequency band of the channel it is sent on.

The *MS Classmark 3* is a type 4 information element with a maximum of 14 octets length.

The value part of a *MS Classmark 3* information element is coded as shown in figure 10.5.7/3GPP TS 24.008 and table 10.5.7/3GPP TS 24.008.

NOTE: The 14 octet limit is so that the CLASSMARK CHANGE message will fit in one layer 2 frame.

SEMANTIC RULE: a multiband mobile station shall provide information about all frequency bands it can support. A single band mobile station shall not indicate the band it supports in the *Multiband Supported*, *GSM 400 Bands Supported*, *GSM 850 Associated Radio Capability* or *PCS 1900 Associated Radio Capability* fields in the MS Classmark 3. Due to shared radio frequency channel numbers between DCS 1800 and PCS 1900, the mobile should indicate support for either DCS 1800 band OR PCS 1900 band.

SEMANTIC RULE: a mobile station shall include the MS Measurement Capability field if the *Multi Slot Class* field contains a value of 19 or greater (see GSM 05.02).

Typically, the number of spare bits at the end is the minimum to reach an octet boundary. The receiver may add any number of bits set to "0" at the end of the received string if needed for correct decoding.

```

<Classmark 3 Value part> ::=
  < spare bit >
  { < Multiband supported : { 000 } >
    < A5 bits >
  | < Multiband supported : { 101 | 110 } >
    < A5 bits >
    < Associated Radio Capability 2 : bit(4) >
    < Associated Radio Capability 1 : bit(4) >
  | < Multiband supported : { 001 | 010 | 100 } >
    < A5 bits >
    < spare bit >(4)
    < Associated Radio Capability 1 : bit(4) > }
  { 0 | 1 < R Support > }
  { 0 | 1 < Multi Slot Capability > }
  < UCS2 treatment: bit >
  < Extended Measurement Capability : bit >
  { 0 | 1 < MS measurement capability > }
  { 0 | 1 < MS Positioning Method Capability > }
  { 0 | 1 < EDGE Multi Slot Capability > }
  { 0 | 1 < EDGE Struct > }
  { 0 | 1 < GSM 400 Bands Supported : { 01 | 10 | 11 } >
    < GSM 400 Associated Radio Capability: bit(4) > }

  { 0 | 1 <GSM 850 Associated Radio Capability : bit(4) > }
  { 0 | 1 <PCS 1900 Associated Radio Capability : bit(4) > }
  < UMTS FDD Radio Access Technology Capability : bit >
  < UMTS TDD Radio Access Technology Capability : bit >
  < CDMA 2000 Radio Access Technology Capability : bit >

  { 0 | 1 < DTM GPRS Multi Slot Sub-Class : bit(2) >
    < MAC Mode Support : bit >
  { 0 | 1 < EGPRS Support : bit DTM EGPRS Multi Slot Sub-Class : bit(2) > }
  { < TETRA band support : 0 >
  | < TETRA band support : 1 >
    < TETRA 380 Associated Radio Capability : bit(4) >
    < TETRA 410 Associated Radio Capability : bit(4) >
    < TETRA 450 Associated Radio Capability : bit(4) >
    < TETRA 870 Associated Radio Capability : bit(4) > }
  < spare bit >;

```

```

< spare bit > ;

< A5 bits > ::=
  < A5/7 : bit > < A5/6 : bit > < A5/5 : bit > < A5/4 : bit > ;

<R Support>::=
  < R-GSM band Associated Radio Capability : bit(3) > ;

< Multi Slot Capability > ::=
  < Multi Slot Class : bit(5) > ;

< MS Measurement capability > ::=
  < SMS_VALUE : bit (4) >
  < SM_VALUE : bit (4) > ;

< MS Positioning Method Capability > ::=
  < MS Positioning Method : bit(5) > ;

< EDGE Multi Slot Capability > ::=
  < EDGE Multi Slot Class : bit(5) > ;

<EDGE Struct> ::=
  < Modulation Capability : bit >
  { 0 | 1 < EDGE RF Power Capability 1: bit(2) > }
  { 0 | 1 < EDGE RF Power Capability 2: bit(2) > }

```

**Figure 10.5.7/3GPP TS 24.008 Mobile Station Classmark 3 information element**

**Table 10.5.7/3GPP TS 24.008: Mobile Station Classmark 3 information element**

Multiband Supported (3 bit field)	
Band 1 supported (third bit of the field)	
Bit	3
0	P-GSM not supported
1	P-GSM supported
Band 2 supported (second bit of the field)	
BIT	2
0	E-GSM or R-GSM not supported
1	E-GSM or R-GSM supported
Band 3 supported (first bit of the field)	
Bit	1
0	DCS 1800 not supported
1	DCS 1800 supported
The indication of support of P-GSM band or E-GSM or R-GSM band is mutually exclusive.	
When the 'Band 2 supported' bit indicates support of E-GSM or R-GSM, the presence of the <R Support> field, see below, indicates if the E-GSM or R-GSM band is supported.	
In this version of the protocol, the sender indicates in this field either none, one or two of these 3 bands supported. If only one band is indicated, the receiver shall ignore the Associated Radio Capability 2.	
For single band mobile station all bits are set to 0.	
A5/4	
Bit	1
0	Encryption algorithm A5/4 not available
1	Encryption algorithm A5/4 available
A5/5	
Bit	1
0	Encryption algorithm A5/5 not available
1	Encryption algorithm A5/5 available

A5/6	Bit	1	
		0	Encryption algorithm A5/6 not available
		1	Encryption algorithm A5/6 available
A5/7		0	Encryption algorithm A5/7 not available
		1	Encryption algorithm A5/7 available
Associated Radio capability 1 and 2 (4 bit fields)			
If either of P-GSM or E-GSM or R-GSM is supported, the radio capability 1 field indicates the radio capability for P-GSM, E-GSM or R-GSM, and the radio capability 2 field indicates the radio capability for DCS1800 if supported, and is spare otherwise.			
If none of P-GSM or E-GSM or R-GSM are supported, the radio capability 1 field indicates the radio capability for DCS1800, and the radio capability 2 field is spare.			
The radio capability contains the binary coding of the power class associated with the band indicated in multiband support bits (see GSM 05.05).			

**Table 10.5.1.7/3GPP TS 24.008 (continued): MS Classmark 3 information element**

<b>R Support</b>		
In case where the R-GSM band is supported the R-GSM band associated radio capability field contains the binary coding of the power class associated (see GSM 05.05). A mobile station supporting the R-GSM band shall also when appropriate, (see 10.5.1.6) indicate its support in the 'FC' bit in the Mobile Station Classmark 2 information element.		
NOTE:	The coding of the power class for P-GSM, E-GSM, R-GSM and DCS 1800 in radio capability 1 and/or 2 is different to that used in the Mobile Station Classmark 1 and Mobile Station Classmark 2 information elements.	
Multi Slot Class (5 bit field)		
In case the MS supports the use of multiple timeslots then the Multi Slot Class field is coded as the binary representation of the multislot class defined in GSM 05.02.		
<b>UCS2 treatment (1 bit field)</b>		
This information field indicates the likely treatment by the mobile station of UCS2 encoded character strings. If not included, the value 0 shall be assumed by the receiver.		
Bit	1	
	0	the ME has a preference for the default alphabet (defined in GSM 03.38) over UCS2.
	1	the ME has no preference between the use of the default alphabet and the use of UCS2.
<b>Extended Measurement Capability (1 bit field)</b>		
This bit indicates whether the mobile station supports "Extended Measurements" or not		
Bit	1	
	0	the MS does not support Extended Measurements
	1	the MS supports Extended Measurements
<b>SMS_VALUE (Switch-Measure-Switch) (4 bit field)</b>		
The SMS field indicates the time needed for the mobile station to switch from one radio channel to another, perform a neighbour cell power measurement, and the switch from that radio channel to another radio channel.		
Bits		
4 3 2 1		
0 0 0 0	1/4 timeslot (~144 $\mu$ s)	
0 0 0 1	2/4 timeslot (~288 $\mu$ s)	
0 0 1 0	3/4 timeslot (~433 $\mu$ s)	
...		
1 1 1 1	16/4 timeslot (~2307 $\mu$ s)	



**SM\_VALUE (Switch-Measure) (4 bit field)**

The SM field indicates the time needed for the mobile station to switch from one radio channel to another and perform a neighbour cell power measurement.

Bits

4 3 2 1

0 0 0 0 1/4 timeslot (~144  $\mu$ s)

0 0 0 1 2/4 timeslot (~288  $\mu$ s)

0 0 1 0 3/4 timeslot (~433  $\mu$ s)

...

1 1 1 1 16/4 timeslot (~2307  $\mu$ s)

**MS Positioning Method Capability (1 bit field)**

This bit indicates whether the MS supports Positioning Method or not for the provision of Location Services.

**MS Positioning Method (5 bit field)**

This field indicates the Positioning Method(s) supported by the mobile station.

MS assisted E-OTD

Bit 5

0 MS assisted E-OTD not supported

1 MS assisted E-OTD supported

**Table 10.5.1.7/3GPP TS 24.008 (continued): MS Classmark 3 information element**

MS based E-OTD

Bit 4

0 MS based E-OTD not supported

1 MS based E-OTD supported

MS assisted GPS

Bit 3

0 MS assisted GPS not supported

1 MS assisted GPS supported

MS based GPS

Bit 2

0 MS based GPS not supported

1 MS based GPS supported

MS conventional GPS

Bit 1

0 conventional GPS not supported

1 conventional GPS supported

**EDGE Multi Slot class (5 bit field)**

In case the EDGE MS supports the use of multiple timeslots and the number of supported time slots is different from number of time slots supported for GMSK then the EDGE Multi Slot class field is included and is coded as the binary representation of the multislots class defined in GSM 05.02.

**Modulation Capability**

Modulation Capability field indicates the supported modulation scheme by MS in addition to GMSK

Bit 1

0 8-PSK supported for downlink reception only

1 8-PSK supported for uplink transmission and downlink reception

**EDGE RF Power Capability 1 (2 bit field)**

If 8-PSK is supported for both uplink and downlink, the **EDGE RF Power Capability 1** field indicates the radio capability for GSM 450, GSM 900, TETRA 380, TETRA 410, TETRA 450 and TETRA 870.

The radio capability contains the binary coding of the EDGE power class(see GSM 05.05).

**EDGE RF Power Capability 2 (2 bit field)**

If 8-PSK is supported for both uplink and downlink, the **EDGE RF Power Capability 2** field indicates the radio capability for DCS1800 or PCS1900 if supported, and is not included otherwise.  
The radio capability contains the binary coding of the EDGE power class (see GSM 05.05).

**Table 10.5.1.7/3GPP TS 24.008 (continued): MS Classmark 3 information element**

**GSM 400 Bands Supported (2 bit field)**

Bits

2 1

0 1 GSM 480 supported, GSM 450 not supported

1 0 GSM 450 supported, GSM 480 not supported

1 1 GSM 450 supported, GSM 480 supported

**GSM 400 Associated Radio Capability (4 bit field)**

If either GSM 450 or GSM 480 or both is supported, the GSM 400 Associated Radio Capability field indicates the radio capability for GSM 450 and/or GSM 480.

The radio capability contains the binary coding of the power class associated with the band indicated in GSM 400 Bands Supported bits (see GSM 05.05).

NOTE: The coding of the power class for GSM 450 and GSM 480 in GSM 400 Associated Radio Capability is different to that used in the Mobile Station Classmark 1 and Mobile Station Classmark 2 information elements.

**GSM 850 Associated Radio Capability (4 bit field)**

This field indicates whether GSM 850 band is supported and its associated radio capability.

The radio capability contains the binary coding of the power class associated with the GSM 850 band (see GSM 05.05).

NOTE: The coding of the power class for GSM 850 in GSM 850 Associated Radio Capability is different to that used in the Mobile Station Classmark 1 and Mobile Station Classmark 2 information elements.

**PCS 1900 Associated Radio Capability (4 bit field)**

This field indicates whether PCS 1900 band is supported and its associated radio capability.

The radio capability contains the binary coding of the power class associated with the PCS 1900 band (see GSM 05.05).

NOTE: The coding of the power class for PCS 1900 in PCS 1900 Associated Radio Capability is different to that used in the Mobile Station Classmark 1 and Mobile Station Classmark 2 information elements.

**Table 10.5.1.7/3GPP TS 24.008 (continued): MS Classmark 3 information element**

<b>UMTS FDD Radio Access Technology Capability (1 bit field)</b>	
Bit	1
0	UMTS FDD not supported
1	UMTS FDD supported
<b>UMTS TDD Radio Access Technology Capability (1 bit field)</b>	
Bit	1
0	UMTS TDD not supported
1	UMTS TDD supported
<b>CDMA 2000 Radio Access Technology Capability (1 bit field)</b>	
Bit	1
0	CDMA2000 not supported
1	CDMA2000 supported
<b>DTM GPRS Multi Slot Sub-Class (2 bit field)</b>	
This field indicates the GPRS DTM capabilities of the MS. The DTM GPRS Multi Slot Sub-Class is independent from the Multi Slot Capabilities field. It is coded as follows:	
Bit	2 1
0 0	Sub-Class 1 supported
0 1	Sub-Class 5 supported
1 0	Sub-Class 9 supported
1 1	Reserved for future extension. If received, the network shall interpret this as '00'
<b>DTM EGPRS Multi Slot Sub-Class (2 bit field)</b>	
This field indicates the EGPRS DTM capabilities of the MS. The DTM EGPRS Multi Slot Sub-Class is independent from the Multi Slot Capabilities field. This field shall be included only if the mobile station supports EGPRS DTM. This field is coded as the DTM GPRS Multi Slot Sub-Class field.	
<b>MAC Mode Support (1 bit field)</b>	
This field indicates whether the MS supports Dynamic and Fixed Allocation or only supports Exclusive Allocation. It is coded as follows:	
Bit	1
0	Dynamic and Fixed Allocation not supported
1	Dynamic and Fixed allocation supported
<b>TETRA 380 Associated Radio Capability (4 bit field)</b>	
This field indicates whether TETRA 380 band is supported and its associated radio capability.	
The radio capability contains the binary coding of the power class associated with the TETRA 380 band (see GSM 05.05).	
NOTE: The coding of the power class for TETRA 380 in TETRA 380 Associated Radio Capability is different to that used in the Mobile Station Classmark 1 and Mobile Station Classmark 2 information elements.	
<b>TETRA 410 Associated Radio Capability (4 bit field)</b>	
This field indicates whether TETRA 410 band is supported and its associated radio capability.	
The radio capability contains the binary coding of the power class associated with the TETRA 410 band (see GSM 05.05).	
NOTE: The coding of the power class for TETRA 410 in TETRA 410 Associated Radio Capability is different to that used in the Mobile Station Classmark 1 and Mobile Station Classmark 2 information elements.	
<b>TETRA 450 Associated Radio Capability (4 bit field)</b>	
This field indicates whether TETRA 450 band is supported and its associated radio capability.	
The radio capability contains the binary coding of the power class associated with the TETRA 450 band (see GSM 05.05).	

NOTE: The coding of the power class for TETRA 450 in TETRA 450 Associated Radio Capability is different to that used in the Mobile Station Classmark 1 and Mobile Station Classmark 2 information elements.

#### **TETRA 870 Associated Radio Capability** (4 bit field)

This field indicates whether TETRA 870 band is supported and its associated radio capability.

The radio capability contains the binary coding of the power class associated with the TETRA 870 band (see GSM 05.05).

NOTE: The coding of the power class for TETRA 870 in TETRA 870 Associated Radio Capability is different to that used in the Mobile Station Classmark 1 and Mobile Station Classmark 2 information elements.

### 10.5.3.2 Authentication Response parameter

The purpose of the *authentication response parameter* information element is to provide the network with the authentication response calculated in the SIM.

The *Authentication Parameter SRES* information element is coded as shown in figure 10.5.76/3GPP TS 24.008 and tables 10.5.90 a and b /3GPP TS 24.008.

The *Authentication Response Parameter* is a type 3 information element with 5 octets length. In a GSM authentication challenge, the response calculated in the SIM (SRES) is 4 bytes in length, and is placed in the *Authentication Response Parameter* information element.

In a UMTS authentication challenge, the response calculated in the SIM (RES) may be up to 16 octets in length. The 4 most significant octets shall be included in the *Authentication Response Parameter* information element. The remaining part of the RES shall be included in the Authentication Response Parameter (extension) IE (see clause 10.5.3.2.1)

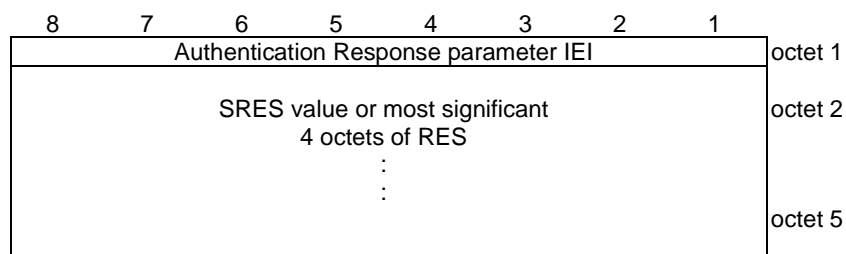

**Figure 10.5.76/3GPP TS 24.008: Authentication Response Parameter information element**

**Table 10.5.90a/3GPP TS 24.008: Authentication Response Parameter information element (SRES) (GSM only)**

<p>SRES value (octet 2, 3, 4 and 5) The SRES value consists of 32 bits. Bit 8 of octet 2 is the most significant bit while bit 1 of octet 5 is the least significant bit.</p>
---

### 10.5.3.3 CM service type

The purpose of the *CM Service Type* information element is to specify which service is requested from the network.

The *CM Service Type* information element is coded as shown in figure 10.5.77/3GPP TS 24.008 and table 10.5.91/3GPP TS 24.008.

The *CM Service Type* is a type 1 information element.

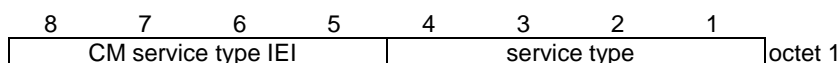

**Figure 10.5.77/3GPP TS 24.008 CM Service Type information element**

**Table 10.5.91/3GPP TS 24.008: CM Service Type information element**

Service type (octet 1)	
Bits	
<b>4 3 2 1</b>	
0 0 0 1	Mobile originating call establishment or packet mode connection establishment
0 1 0 0	Short message service
1 0 1 1	Location Services
All other values are reserved.	

### 10.5.5.12a MS Radio Access capability

The purpose of the *MS RA capability* information element is to provide the radio part of the network with information concerning radio aspects of the mobile station. The contents might affect the manner in which the network handles the operation of the mobile station.

The *MS RA capability* is a type 4 information element, with a maximum length of 52 octets.

The value part of a *MS RA capability* information element is coded as shown in table 10.5.146/3GPP TS 24.008.

- SEMANTIC RULE: Among the three Access Type Technologies GSM 900-P, GSM 900-E and GSM 900-R only one shall be present.
- The MS shall indicate supported Access Technology Types. e.g. [450, 480, 900, 1 800, UMTS] or [850, 1 900] MHz bands during a single MM procedure.
- Error handling : If a received Access Technology Type is unknown to the receiver, it shall ignore all the corresponding fields;
- If within a known Access Technology Type a receiver recognizes an unknown field it shall ignore it.
- See more details about error handling of MS radio access capability in 3GPP TS 08.18.
- Due to shared radio frequency channel numbers between 1800 and 1900, the mobile should provide the relevant MS Radio Access capability for either 1800 band OR 1900 band, not both.

**Table 10.5.146/3GPP TS 24.008 : Mobile Station Radio Access Capability Information Element**

```

< MS Radio Access capability IE > ::=
<MS Radio Access capability IEI : 00100100 >
<Length of MS RA capability: <octet>> -- length in octets of MS RA capability value part and spare bits
<MS RA capability value part : < MS RA capability value part struct >>
<spare bits>*; -- may be used for future enhancements

<MS RA capability value part struct >::= --recursive structure allows any number of Access technologies
< Access Technology Type: bit (4) >
< Access capabilities : <Access capabilities struct> >
{ 0 | 1 <MS RA capability value part struct> } ;

< Access capabilities struct > ::=
  < Length : bit (7) > -- length in bits of Content and spare bits

```

```

<Access capabilities : <Content>>
<spare bits>** ; -- expands to the indicated length
    -- may be used for future enhancements

< Content > ::=
  < RF Power Capability : bit (3) >
  { 0 | 1 <A5 bits : <A5 bits> > } -- zero means that the same values apply for parameters as in the immediately
preceding Access capabilities field within this IE
-- The presence of the A5 bits is mandatory in the 1st Access capabilities struct within this IE.
  < ES IND : bit >
  < PS : bit >
  < VGCS : bit >
  < VBS : bit >
  { 0 | 1 < Multislot capability : Multislot capability struct > } ; -- zero means that the same values for multislot
parameters as given in an earlier Access capabilities field within this IE apply also here
  { 0 | 1 < 8PSK Power Capability : bit(2) > } - '1' also means 8PSK modulation capability in uplink. <
COMPACT Interference Measurement Capability : bit >
  < Revision Level Indicator : bit >
  < UMTS FDD Radio Access Technology Capability : bit > -- 3G RAT
  < UMTS TDD Radio Access Technology Capability : bit > -- 3G RAT
  < CDMA 2000 Radio Access Technology Capability : bit > -- 3G RAT
    -- error: struct too short, assume features do not exist
-- error: struct too long, ignore data and jump to next Access technology

```

**Table 10.5.146/3GPP TS 24.008 (continued): Mobile Station Radio Access Capability Information Element**

```

< Multislot capability struct > ::=
  { 0 | 1 < HSCSD multislot class : bit (5) > }
  { 0 | 1 < GPRS multislot class : bit (5) > < GPRS Extended Dynamic Allocation Capability : bit > }
  { 0 | 1 < SMS_VALUE : bit (4) > < SM_VALUE : bit (4) > } ;
  { 0 | 1 < ECSD multislot class : bit (5) > }
  { 0 | 1 < EGPRS multislot class : bit (5) > < EGPRS Extended Dynamic Allocation Capability : bit > } ;

  {0|1 < DTM GPRS Multi Slot Sub-Class: bit(2)>
  <MAC Mode Support : bit>
  {0 | 1 <DTM EGPRS Multi Slot Sub-Class : bit(2)> } ;

<A5 bits> ::= < A5/1 : bit> <A5/2 : bit> <A5/3 : bit> <A5/4 : bit> <A5/5 : bit> <A5/6 : bit> <A5/7 : bit>; -- bits for
circuit mode ciphering algorithms

Access Technology Type
This field indicates the access technology type to be associated with the following access capabilities.

Bits
4 3 2 1
0 0 0 0 GSM P
0 0 0 1 GSM E --note that GSM E covers GSM P
0 0 1 0 GSM R --note that GSM R covers GSM E and GSM P
0 0 1 1 GSM 1800
0 1 0 0 GSM 1900
0 1 0 1 GSM 450
0 1 1 0 GSM 480
0 1 1 1 GSM 850
1 0 0 0 TETRA 380
1 0 0 1 TETRA 410
1 0 1 0 TETRA 450
1 0 1 1 TETRA 870

```

All other values are treated as unknown by the receiver.

**RF Power Capability**

This field is coded as radio capability in Classmark 3 for the indicated band: it contains the binary coding of the power class associated (see GSM 05.05 paragraph 4.1 output power and paragraph 4.1.1 Mobile Station).

**8PSK Power Capability**

This field is coded according to the definition in GSM 05.05. The presence of this field indicates also 8PSK modulation capability in uplink.

**A5/1**

0 encryption algorithm A5/1 not available

1 encryption algorithm A5/1 available

**A5/2**

0 encryption algorithm A5/2 not available

1 encryption algorithm A5/2 available

**A5/3**

0 encryption algorithm A5/3 not available

1 encryption algorithm A5/3 available

**A5/4**

0 encryption algorithm A5/4 not available

1 encryption algorithm A5/4 available

**A5/5**

0 encryption algorithm A5/5 not available

1 encryption algorithm A5/5 available

**A5/6**

0 encryption algorithm A5/6 not available

1 encryption algorithm A5/6 available

**A5/7**

0 encryption algorithm A5/7 not available

1 encryption algorithm A5/7 available

**ES IND - (Controlled early Classmark Sending)**

0 "controlled early Classmark Sending" option is not implemented

1 "controlled early Classmark Sending" option is implemented

**Table 10.5.146/3GPP TS 24.008 (concluded): Mobile Station Radio Access Capability Information Element**

**PS - (Pseudo Synchronization)**

0 PS capability not present

1 PS capability present

**VGCS - (Voice Group Call Service)**

0 no VGCS capability or no notifications wanted

1 VGCS capability and notifications wanted.

**VBS - (Voice Broadcast Service)**

0 no VBS capability or no notifications wanted

1 VBS capability and notifications wanted

**HSCSD Multi Slot Class**

The Multi Slot Class field is coded as the binary representation of the multislot class defined in GSM 05.02. Range 1 to 18, all other values are reserved.

**GPRS Multi Slot Class**

The GPRS Multi Slot Class field is coded as the binary representation of the multislot class defined in GSM 05.02.

**ECSD Multi Slot Class**

The presence of this field indicates ECSD capability. Whether the MS is capable of 8-PSK modulation in uplink is indicated by the presence of 8-PSK Power Capability field. The Multi Slot Class field is coded as the binary representation of the multislot class defined in GSM 05.02.

Range 1 to 18, all other values are reserved.

#### **EGPRS Multi Slot Class**

The presence of this field indicates EGPRS capability. Whether the MS is capable of 8-PSK modulation in uplink is indicated by the presence of 8-PSK Power Capability field. The EGPRS Multi Slot Class field is coded as the binary representation of the multislot class defined in GSM 05.02.

#### **GPRS Extended Dynamic Allocation Capability**

0 Extended Dynamic Allocation Capability for GPRS is not implemented

1 Extended Dynamic Allocation Capability for GPRS is implemented

#### **EGPRS Extended Dynamic Allocation Capability**

0 Extended Dynamic Allocation Capability for EGPRS is not implemented

1 Extended Dynamic Allocation Capability for EGPRS is implemented

#### **SMS\_VALUE (Switch-Measure-Switch) (4 bit field)**

The SMS field indicates the time needed for the mobile station to switch from one radio channel to another, perform a neighbour cell power measurement, and the switch from that radio channel to another radio channel.

Bits

4 3 2 1

0 0 0 0 1/4 timeslot (~144  $\mu$ s)

0 0 0 1 2/4 timeslot (~288  $\mu$ s)

0 0 1 0 3/4 timeslot (~433  $\mu$ s)

...

1 1 1 1 16/4 timeslot (~2307  $\mu$ s)

#### **(SM\_VALUE) Switch-Measure (4 bit field)**

The SM field indicates the time needed for the mobile station to switch from one radio channel to another and perform a neighbour cell power measurement.

Bits

4 3 2 1

0 0 0 0 1/4 timeslot (~144  $\mu$ s)

0 0 0 1 2/4 timeslot (~288  $\mu$ s)

0 0 1 0 3/4 timeslot (~433  $\mu$ s)

...

1 1 1 1 16/4 timeslot (~2307  $\mu$ s)

#### **DTM GPRS Multi Slot Sub-Class (2 bit field)**

This field indicates the GPRS DTM capabilities of the MS. The GPRS DTM Multi Slot Sub-Class is independent from the Multi Slot Capabilities field.

Bits

2 1

0 0 Sub-Class 1 supported

0 1 Sub-Class 5 supported

1 0 Sub-Class 9 supported

1 1 Reserved for future extension. If received, the network shall interpret this as '00'

#### **DTM EGPRS Multi Slot Sub-Class (2 bit field)**

This field indicates the EGPRS DTM capabilities of the MS. The DTM EGPRS Multi Slot Sub-Class is independent from the Multi Slot Capabilities field. This field shall be included only if the mobile station supports EGPRS DTM. This field is coded as the DTM GPRS Multislot Sub-Class field.

#### **MAC Mode Support (1 bit field)**

This field indicates whether the MS supports Dynamic and Fixed Allocation or only supports Exclusive Allocation

Bits

1

0 Dynamic and Fixed Allocation not supported

1 Dynamic and Fixed allocation supported

#### **COMPACT Interference Measurement Capability**

0 COMPACT Interference Measurement Capability is not implemented

1 COMPACT Interference Measurement Capability is implemented



<b>vision Level Indicator</b> (1 bit field)	
Bit	
0	The ME is Release '98 or older
1	The ME is Release '99 onwards
<b>UMTS FDD Radio Access Technology Capability</b> (1 bit field)	
Bit	
0	UMTS FDD not supported
1	UMTS FDD supported
<b>UMTS TDD Radio Access Technology Capability</b> (1 bit field)	
Bit	
0	UMTS TDD not supported
1	UMTS TDD supported
<b>CDMA 2000 Radio Access Technology Capability</b> (1 bit field)	
Bit	
0	CDMA2000 not supported
1	CDMA2000 supported

## 11.2.2 Timers of GPRS mobility management

**Table 11.3/3GPP TS 24.008: GPRS Mobility management timers - MS side**

TIMER NUM.	TIMER VALUE	STATE	CAUSE OF START	NORMAL STOP	ON THE 1 <sup>st</sup> , 2 <sup>nd</sup> , 3 <sup>rd</sup> , 4 <sup>th</sup> EXPIRY Note 3
T3310	15 s	GMM-REG-INIT	ATTACH REQ sent	ATTACH ACCEPT received ATTACH REJECT received	Retransmission of ATTACH REQ
T3311	15 s	GMM-DEREG ATTEMPTING TO ATTACH or GMM-REG ATTEMPTING TO UPDATE	ATTACH REJ with other cause values as described in chapter "GPRS Attach" ROUTING AREA UPDATE REJ with other cause values as described in chapter "Routing Area Update" Low layer failure	Change of the routing area	Restart of the Attach or the RAU procedure with updating of the relevant attempt counter
T3318	20 s	GMM-REG-INIT GMM-REG GMM-DEREG-INIT GMM-RA-UPDATING-INT	AUTHENTICATION and CIPHERING FAILURE (cause=MAC failure) sent	AUTHENTICATION and CIPHERING REQUEST received	On first expiry, the MS should consider the network as false (see 4.7.7.6.1)
T3320	15 s	GMM-REG-INIT GMM-REG GMM-DEREG-INIT GMM-RA-UPDATING-INT	AUTHENTICATION and CIPHERING FAILURE (cause=synch failure) sent	AUTHENTICATION and CIPHERING REQUEST received	On first expiry, the MS should consider the network as false (see 4.7.7.6.1)
T3321	15 s	GMM-DEREG-INIT	DETACH REQ sent	DETACH ACCEPT received	Retransmission of the DETACH REQ

TIMER NUM.	TIMER VALUE	STATE	CAUSE OF START	NORMAL STOP	ON THE 1 <sup>st</sup> , 2 <sup>nd</sup> , 3 <sup>rd</sup> , 4 <sup>th</sup> EXPIRY Note 3
T3330	15 s	GMM-ROUTING-UPDATING-INITIATED	ROUTING AREA UPDATE REQUEST sent	ROUTING AREA UPDATE ACC received  ROUTING AREA UPDATE REJ received	Retransmission of the ROUTING AREA UPDATE REQUEST message

Table 11.3a/3GPP TS 24.008: GPRS Mobility management timers - MS side

TIMER NUM.	TIMER VALUE	STATE	CAUSE OF START	NORMAL STOP	ON EXPIRY
T3302	Default 12 minutes (see note 1)	GMM-DEREG or GMM-REG	At attach failure and the attempt counter is greater than or equal to 5. At routing area updating failure and the attempt counter is greater than or equal to 5.	At successful attach  At successful routing area updating	On every expiry, initiation of the GPRS attach procedure or RAU procedure
T3312	Default 54 minutes (see note1)	GMM-REG	In GSM, when READY state is left.	When entering state GMM-DEREG	Initiation of the Periodic RAU procedure
T3314 READY (GSM only)	Default 44 s (see note 2)	All except GMM-DEREG	Transmission of a PTP PDU	Forced to Standby	No cell-updates are performed

NOTE 1: The value of this timer is used if the network does not indicate another value in a GMM signalling procedure.

NOTE 2: The default value of this timer is used if neither the MS nor the Network send another value, or if the Network sends this value, in a signalling procedure.

NOTE 3: Typically, the procedures are aborted on the fifth expiry of the relevant timer. Exceptions are described in the corresponding procedure description.

Table 11.4/3GPP TS 24.008: GPRS Mobility management timers - network side

TIMER NUM.	TIMER VALUE	STATE	CAUSE OF START	NORMAL STOP	ON THE 1 <sup>st</sup> , 2 <sup>nd</sup> , 3 <sup>rd</sup> , 4 <sup>th</sup> EXPIRY Note 3
T3322	6 s	GMM-DEREG-INIT	DETACH REQ sent	DETACH ACCEPT received	Retransmission of DETACH REQUEST
T3350	6 s	GMM-COMMON-PROC-INIT	ATTACH ACCEPT sent with P-TMSI and/or TMSI  RAU ACCEPT sent with P-TMSI and/or TMSI P-TMSI REALLOC COMMAND sent	ATTACH COMPLETE received RAU COMPLETE received P-TMSI REALLOC COMPLETE received	Retransmission of the same message type, i.e. ATTACH ACCEPT, RAU ACCEPT or REALLOC COMMAND
T3360	6 s	GMM-COMMON-PROC-INIT	AUTH AND CIPH REQUEST sent	AUTH AND CIPH RESPONSE received AUTHENT- AND CIPHER- FAILURE received	Retransmission of AUTH AND CIPH REQUEST
T3370	6 s	GMM-COMMON-PROC-INIT	IDENTITY REQUEST sent	IDENTITY RESPONSE received	Retransmission of IDENTITY REQUEST

**Table 11.4a/3GPP TS 24.008: GPRS Mobility management timers - network side**

<b>TIMER NUM.</b>	<b>TIMER VALUE</b>	<b>STATE</b>	<b>CAUSE OF START</b>	<b>NORMAL STOP</b>	<b>ON EXPIRY</b>
T3313	(see note 1)	GMM_REG	Paging procedure initiated	Paging procedure completed	Network dependent
T3314 READY (GSM only)	Default 44 s (see note 2)	All except GMM- DEREG	Receipt of a PTP PDU	Forced to Standby	The network shall page the MS if a PTP PDU has to be sent to the MS
Mobile Reachable	Default 4 minutes greater than T3312	All except GMM- DEREG	In GSM, change from READY to STANDBY state	PTP PDU received	Network dependent but typically paging is halted on 1st expiry

NOTE 1: The value of this timer is network dependent.

NOTE 2: The default value of this timer is used if neither the MS nor the Network send another value, or if the Network sends this value, in a signalling procedure. The value of this timer should be slightly shorter in the network than in the MS, this is a network implementation issue.

NOTE 3: Typically, the procedures are aborted on the fifth expiry of the relevant timer. Exceptions are described in the corresponding procedure description.

## Annex J (normative): Modification to 3GPP TS 24.011

This annex details the modified clauses of 3GPP TS 24.011 which are applicable to TAPS.

All references to other GSM standards and specifications are to the standards as modified by the present document.

The following clauses have the same numbering as in 3GPP TS 24.011.

### 1.2 Abbreviations

Abbreviations used in the present document are listed in 3GPP TS 01.04 and 3GPP TR 21.905, except below:

**RR connection:** A RR connection is a dedicated physical circuit switched domain connection used by the two RR or RRC peer entities to support the upper layers' exchange of information flows.

**PS signalling connection:** is a peer to peer UMTS connection between MS and CN packet domain node.

**GPRS:** Packet Services for GSM and UMTS system.

**SIM:** Subscriber Identity Module (see 3GPP TS 02.17). This specification makes no distinction between SIM and USIM.

**MS:** Mobile Station. This specification makes no distinction between MS and UE.

## 2 Overview of Short Message Service (SMS) support

The purpose of the Short Message Service is to provide the means to transfer messages between a GSM PLMN Mobile Station (MS) and a Short Message Entity via a Service Centre, as described in 3GPP TS 23.040. The terms "MO" - Mobile Originating - and "MT" - Mobile Terminating - are used to indicate the direction in which the short message is sent.

The present document describes the procedures necessary to support the Short Message Service between the MS and the MSC or SGSN and vice versa, as described in 3GPP TS 23.040.

The procedures are based on services provided by the Mobility Management sublayer as described in 3GPP TS 04.64 for GPRS services.

### 2.1 Protocols and protocol architecture

The hierarchical model in figure 2.1b shows the layer structure of the SGSN and the MS.

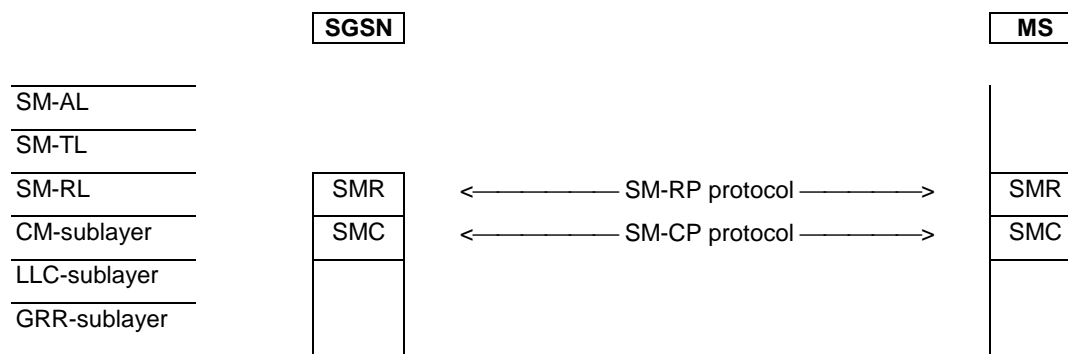

Figure 2.1b/3GPP TS 24.011: Protocol hierarchy for GPRS in A/Gb mode

The CM-sublayer, in terms of the Short Message Service Support, provides services to the Short Message Relay Layer.

On the MS-side the Short Message Relay Layer provides services to the Short Message Transfer Layer. The Short Message Relay Layer is the upper layer on the network side (MSC or SGSN), and the SM-user information elements are mapped to TCAP/MAP.

The peer protocol between two SMC entities is denoted SM-CP, and between two SMR entities, SM-RP.

Abbreviations:

SM-AL	Short Message Application Layer
SM-TL	Short Message Transfer Layer
SM-RL	Short Message Relay Layer
SM-RP	Short Message Relay Protocol
SMR	Short Message Relay (entity)
CM-sub	Connection Management sublayer
SM-CP	Short Message Control Protocol
SMC	Short Message Control (entity)
MM-sub	Mobility Management sublayer
GMM-sub	GPRS Mobility Management sublayer
RR-sub	Radio Resource Management sublayer
LLC-sub	Logical Link Control sublayer
GRR-sub	GPRS Radio Resource sublayer in GSM

## 2.4 Layer 2 (LLC) GPRS support (A/Gb mode only)

It shall be possible for a GPRS-attached MS of class C to send and receive short messages over GPRS radio channels.

GPRS shall use the unacknowledged mode of LLC frame transfer as described in 3GPP TS 04.64, and shall use SAPI 7 to identify the SMS Logical Link Entity within the LLC layer.

A description of the different GPRS MS classes can be found in 23.060, and a brief overview is given below:

- Class C MSs may be able to send and receive short messages using only the LLC layer (using the PDTCH). The capability for GPRS-attached class-C MSs to receive and transmit SMS messages is optional.

## 3.2 Service provided by the CM-sublayer

In order to support the Short Message Service, the CM-sublayer provides services to the Short Message Relay Layer.

The CM-sublayer services are provided using layer specific functions and lower layer services offered to the CM-sublayer, controlled by short message service control entities called SMCs.

An SMC entity in the MS communicates with an SMC entity in the MSC or SGSN by means of a peer protocol, SM-CP (Short Message Service Control Protocol). The arrow diagrams in annex A give an overview of the messaging on the CM-sublayer during a short message transfer.

A mobile station supporting the Short Message Service shall have a minimum of two SMC entities per service type (i.e. two for GPRS). This enables the MS to receive MT messages during an MO message transfer.

To ensure that an MS having the minimum of two SMC entities is able to receive MT messages during an MO message transfer, and to send MO messages during MT message transfer, parallel message transfer in the same direction is prohibited. This means that the SMC entities shall not simultaneously perform messaging in the same direction. The rules for concatenation of message transfers are described in clause 5.4.

The MSC or SGSN shall have a minimum of two SMC entities available each during an MT message transfer to a mobile station, one being reserved for MO message transfer. In an MO message transfer, the MSC or SGSN shall have one SMC entity reserved for handling of an MT message.

### 3.2.1.1 MNSMS-ABORT-REQuest

A request from an SMR entity to release a CM-connection in abnormal cases.

### 3.2.1.4 MNSMS-ESTablish-REQuest

A request from an SMR entity to establish a CM-connection. The request contains a RP-DATA UNIT as a parameter. It implies the:

- establishment of a CM-connection for this SMR entity; and
- forming of the CP-DATA message containing the RPDU.

### 3.2.1.6 MNSMS-ERROR-INDication

An indication used by the SMC entity to pass error information to SM-RL. The error information may be local or relayed by the CP-ERROR message.

Use of this service primitive implies release of CM -connection.

### 3.2.1.7 MNSMS-RELease-REQuest

A request to release the CM-connection (if it still exists).

Use of this service primitive implies release of the associated CM connections.

### 3.2.2.4 MNSMS-ESTablish-REQuest

A request from an SMR entity to transmit a RPDU, containing the SM-user information element; it implies the:

- establishment of a CM-connection for this SMR entity; and
- forming of the CP-DATA message containing the RPDU.

### 3.2.2.6 MNSMS-ERROR-INDication

An indication used by the SMC entity to pass error information to SM-RL. The error information may be local or relayed by the CP-ERROR message.

Use of the service primitive implies release of CM connection.

### 3.2.2.7 MNSMS-RELease-REQuest

A request to release the CM-connection (if it still exists).

Use of this service implies release of the associated CM connections.

## 5.1 General

This clause describes the procedures used by the SMC entity on the Connection Management sublayer. An SMC entity communicates with a corresponding peer entity using the LLC layer for GPRS in A/Gb mode.

For GPRS, no connection has to be established, and thus the CM procedures for GPRS reflect this. Detailed SDL diagrams for SMC entities are contained in annex B.

### 5.3.4 Abnormal cases

Abnormal cases that shall be handled by the SMC entity in any state can be classified into five cases:

- **Upper Layer Abort:** Errors occurring in the SM-RL may cause the SM-RL to send an MNSMS-ABORT Request to the SMC entity.
- **CP-Layer Abort:** Errors occurring within the SMC entity itself may require termination of all activities related to that transaction identifier.

- **Lower Layer Abort:** Errors occurring within the layers beneath the CP-layer may cause an MMSM-ERROR Indication or a GMMSMS-ERROR Indication to be sent to the SMC entity.
- **CP-Layer Protocol Errors:** Errors occurring within the protocol exchange between the SMC entities may result in the sending of a CP-ERROR message between the entities.
- **Lower Layer Release:** Events occurring within the layers beneath the CP layer may cause an MMSM-REL Indication to be sent to the SMC entity.

When the CM-sublayer in the network receives an Upper Layer Abort, it may form and send the CP-ERROR message to release the connection. The SMC entity in the network then enters the Idle state.

In the case of a CP-Layer Abort, an error indication is passed to SM-RL. If possible, a CP-ERROR message is sent to the partner SMC entity to indicate the error situation. Then the SMC entity enters the Idle state.

In the case of a Lower Layer Abort, the SMC entity passes an error indication to SM-RL, the SMC entity immediately enters the Idle state.

In the case of the reception of a CP-ERROR message from the partner SMC entity, an error indication is passed to SM-RL, and the SMC entity enters the Idle state.

In the case of a lower layer release, the SMC entity passes an MMSM-ERROR Indication to SM-RL and then enters the Idle state.

In all cases, if the timer TC1\* is running, it is reset.

It is possible that the CP-ACK of a short message transfer might not be received (e.g. due to hand over). If the first CP-ACK (acknowledging the CP-DATA that carried the first RPDU) is not received the reception of CP-DATA may be interpreted as the reception of the awaited CP-ACK and CP-DATA message.

## 9.2 CP Error Handling

Upon receiving a CP-ERROR message the SMC-GP entity (in any state) shall pass an error indication to SM-RL and enter the Idle State.

After sending a CP-ERROR message the SMC-GP entity (in any state) shall enter the Idle State.

---

## Annex A to TS 24.011 (informative): Arrow diagrams

### Arrow diagram A1:

The diagram shows CS MO-message transfer by means of interlayer service primitives and the actual messages being transferred between the layer entities.

### Arrow diagram A2:

The diagram shows CS MT-messaging by means of interlayer service primitives and the actual messages being transferred between the layer entities in A/Gb mode.

### Arrow diagram A5:

The diagram shows GPRS MO-message transfer by means of interlayer service primitives and the actual messages being transferred between the layer entities.

- MNSMS-primitives indicate services provided by CM to SM-RL.
- LLSMS-primitives indicate services provided by LLC to CM.
- CP-DATA is the CM-message carrying SM-RP data units.
- CP-ACK acknowledge CP-DATA reception on CM.

### Arrow diagram A6:

The diagram shows GPRS MT-message transfer by means of interlayer service primitives and the actual messages being transferred between the layer entities in A/Gb mode.

- MNSMS-primitives indicate services provided by CM to SM-RL.
- LLSMS-primitives indicate services provided by LLC to CM.
- CP-DATA is the CM-message carrying SM-RP data units.
- CP-ACK acknowledge CP-DATA reception on CM.

### Arrow diagram A7:

The diagram shows Iu mode PS MO-message transfer by means of interlayer service primitives and the actual messages being transferred between the layer entities.

- MNSMS-primitives indicate services provided by CM to SM-RL.
- PMMSMS-primitives indicate services provided by GMM to CM.
- CP-DATA is the CM-message carrying SM-RP data units.
- CP-ACK acknowledge CP-DATA reception on CM.

### Arrow diagram A8:

The diagram shows Iu mode PS MT-messaging by means of interlayer service primitives and the actual messages being transferred between the layer entities.

- MNSMS-primitives indicate services provided by CM to SM-RL.
- PMMSMS-primitives indicate services provided by GMM to CM.
- CP-DATA is the CM-message carrying SM-RP data units.
- CP-ACK acknowledge CP-DATA reception on CM.



### Mobile Originated Messaging on CM-sublayer

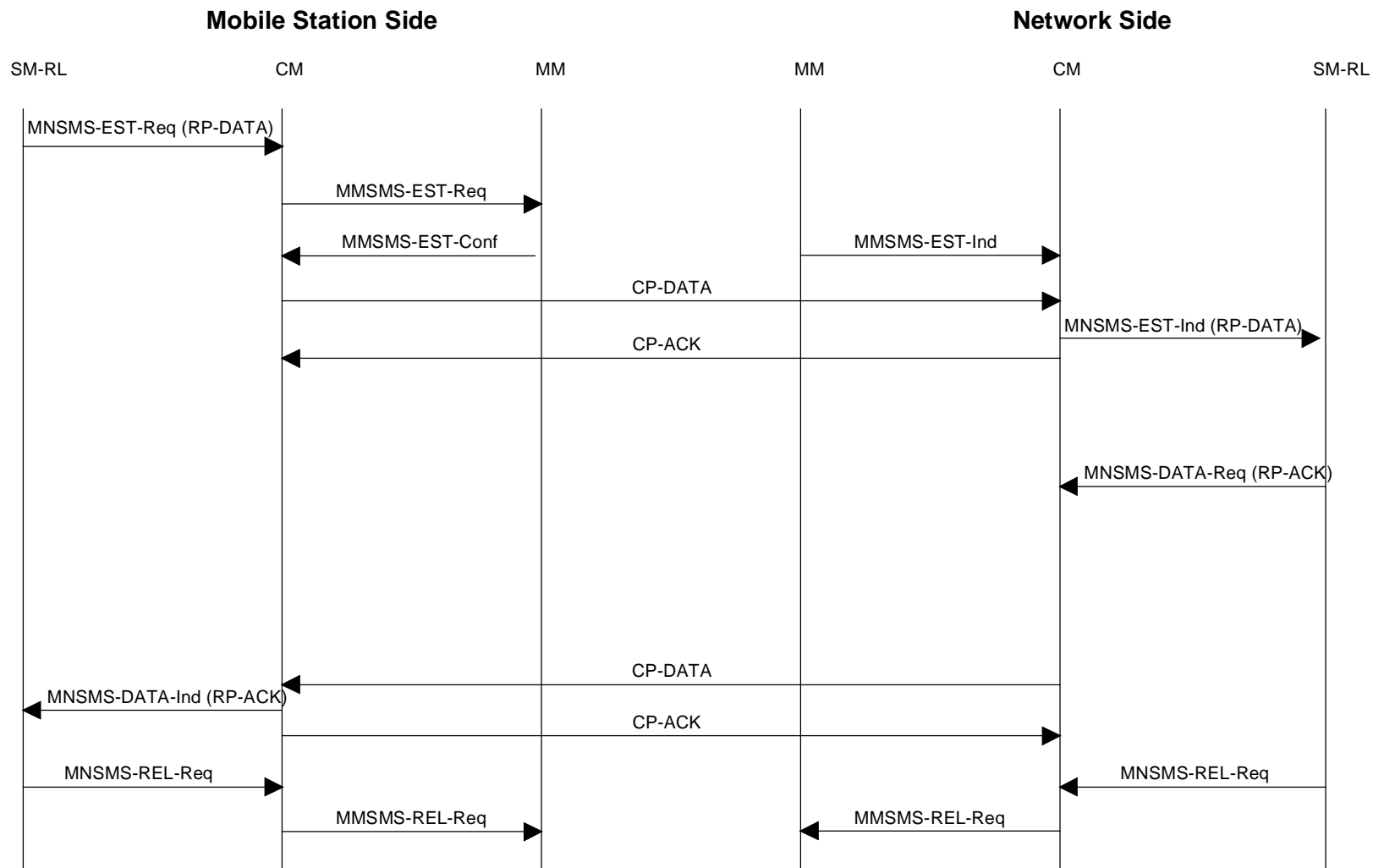

Arrow diagram A1

Mobile Terminated Messaging on CM-sublayer

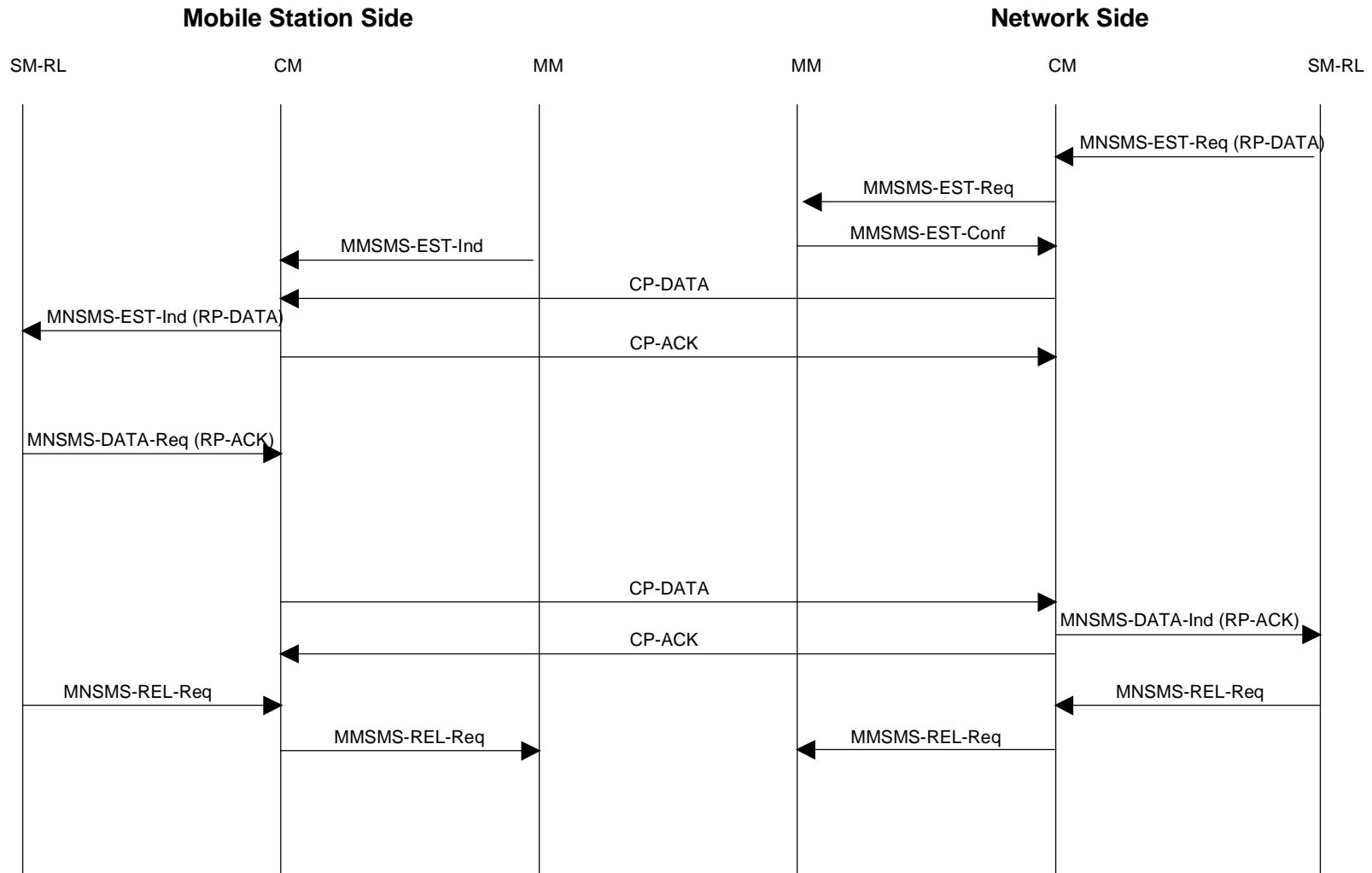

Arrow diagram A2



GPRS Mobile Terminated Messaging on CM-sublayer in A/Gb mode

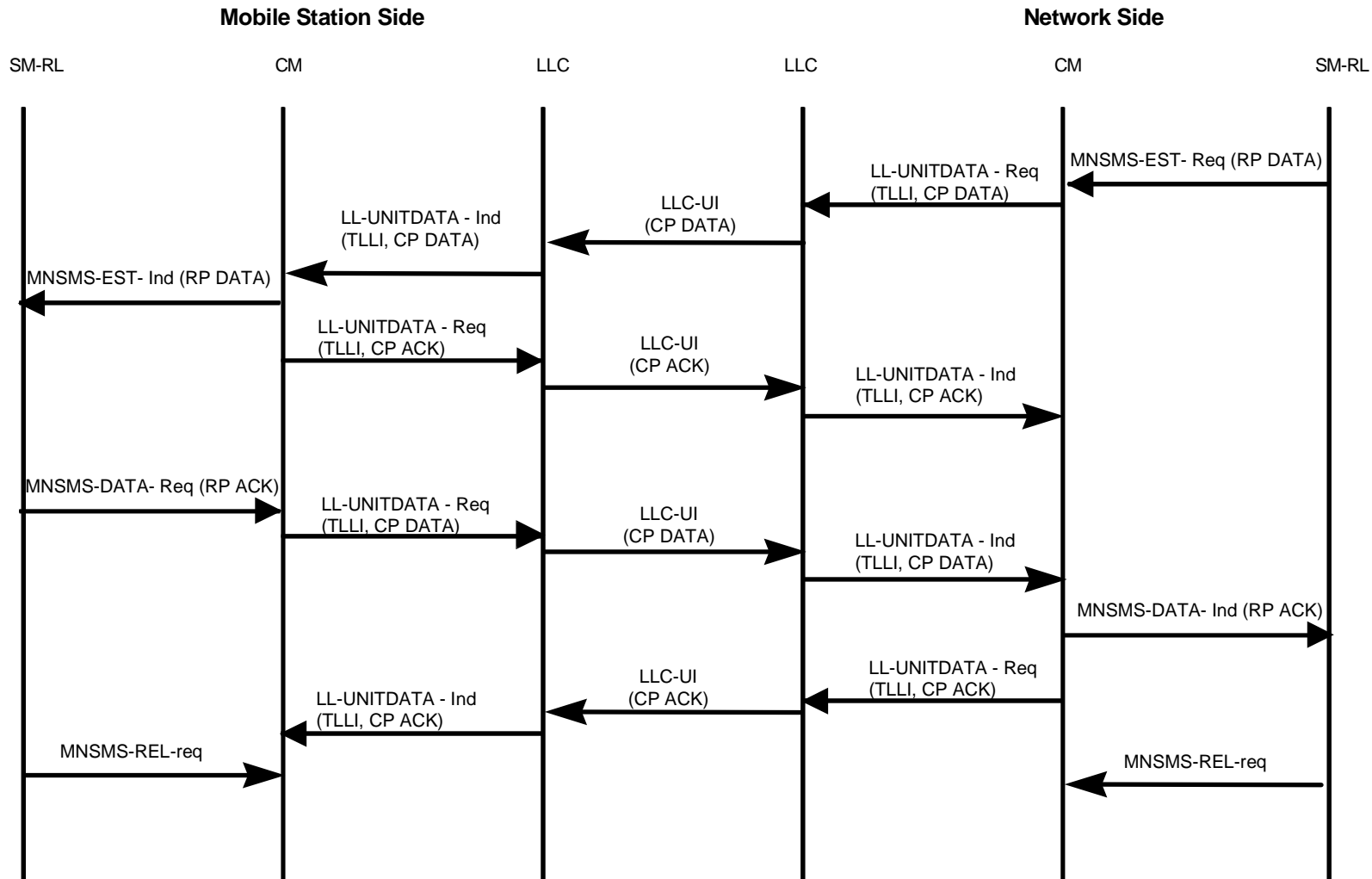

Arrow diagram A6

## B.1 Introduction

This annex contains an SDL-description of the Connection Management Sublayer in terms of the Short Message Service Support. The CM- sublayer provides services to Short Message Relay Layer.

The SDLs contain a mixture of peer-to-peer messages and conceptual primitives between the layers SM-RL, CM, MM and LLC, as viewed by the SMC entities.

- SDL-13/14/15 show the GPRS SMC entity on MS-side for Mobile Originated (MO) short message transfer,
- SDL-16/17/18 show the GPRS SMC entity on MS-side for Mobile Terminated (MT) short message transfer,
- SDL-19/20/21 show the GPRS SMC entity on the network side for Mobile Originated (MO) short message transfer, and
- SDL-22/23/24 show the GPRS SMC entity on the network side for Mobile Terminated (MT) short message transfer.

The lower layers (below GMM and LLC) are transparent to an SMC entity.

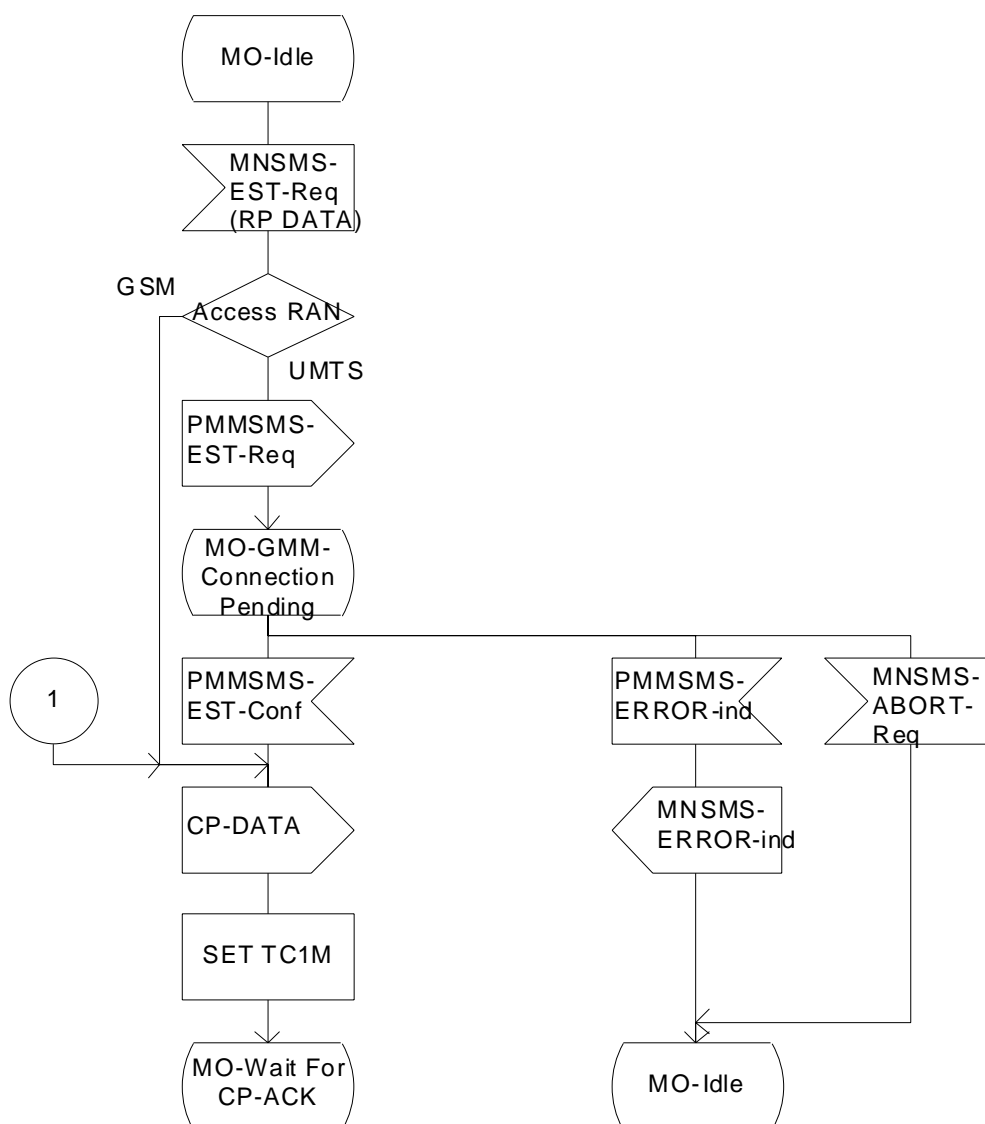

**MO-SMC-GP entity on MS-side for GPRS  
SDL-13**

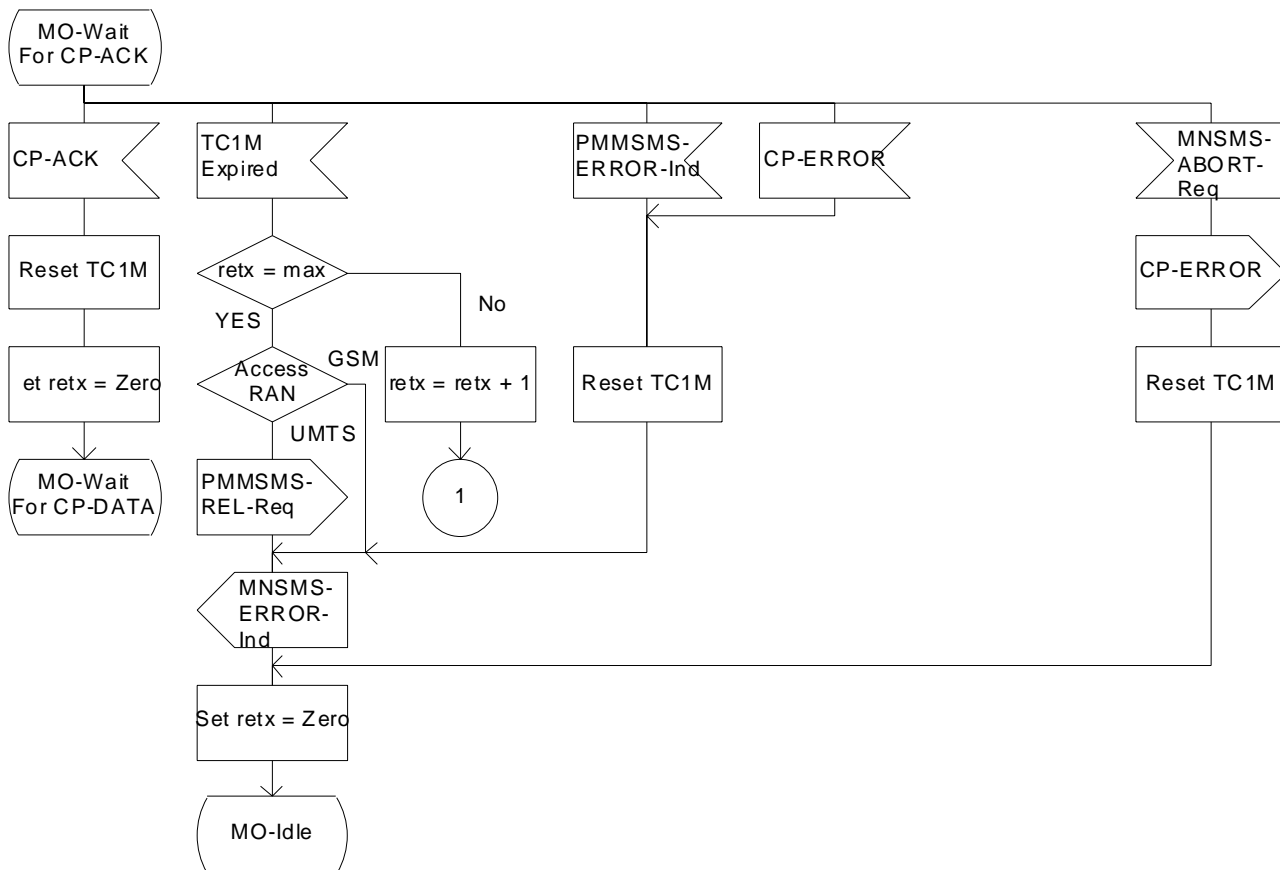

**MO-SMC-GP entity on MS-side for GPRS  
SDL-14**

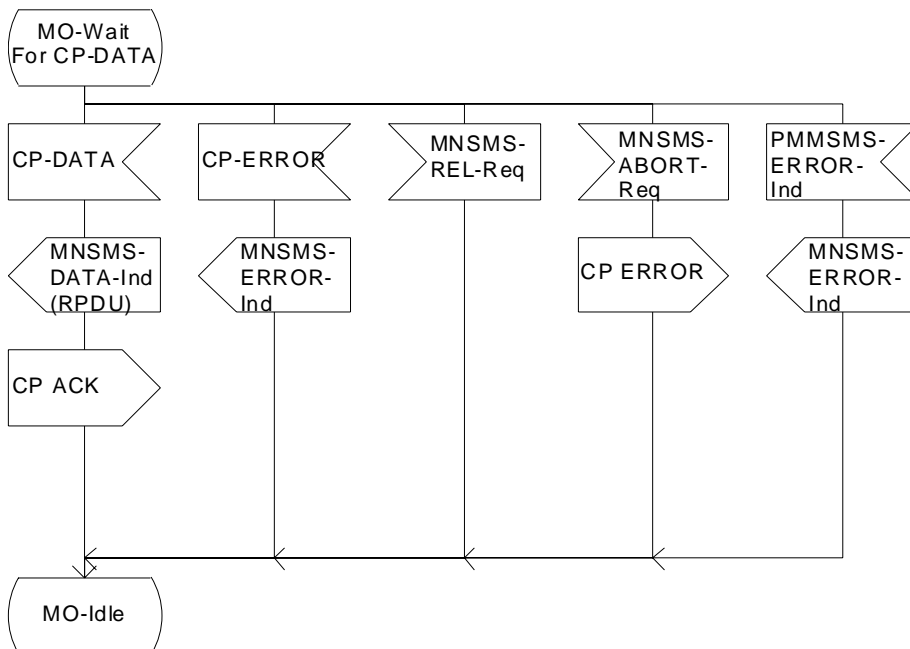

**MO-SMC-GP entity on MS-side for GPRS  
SDL-15**

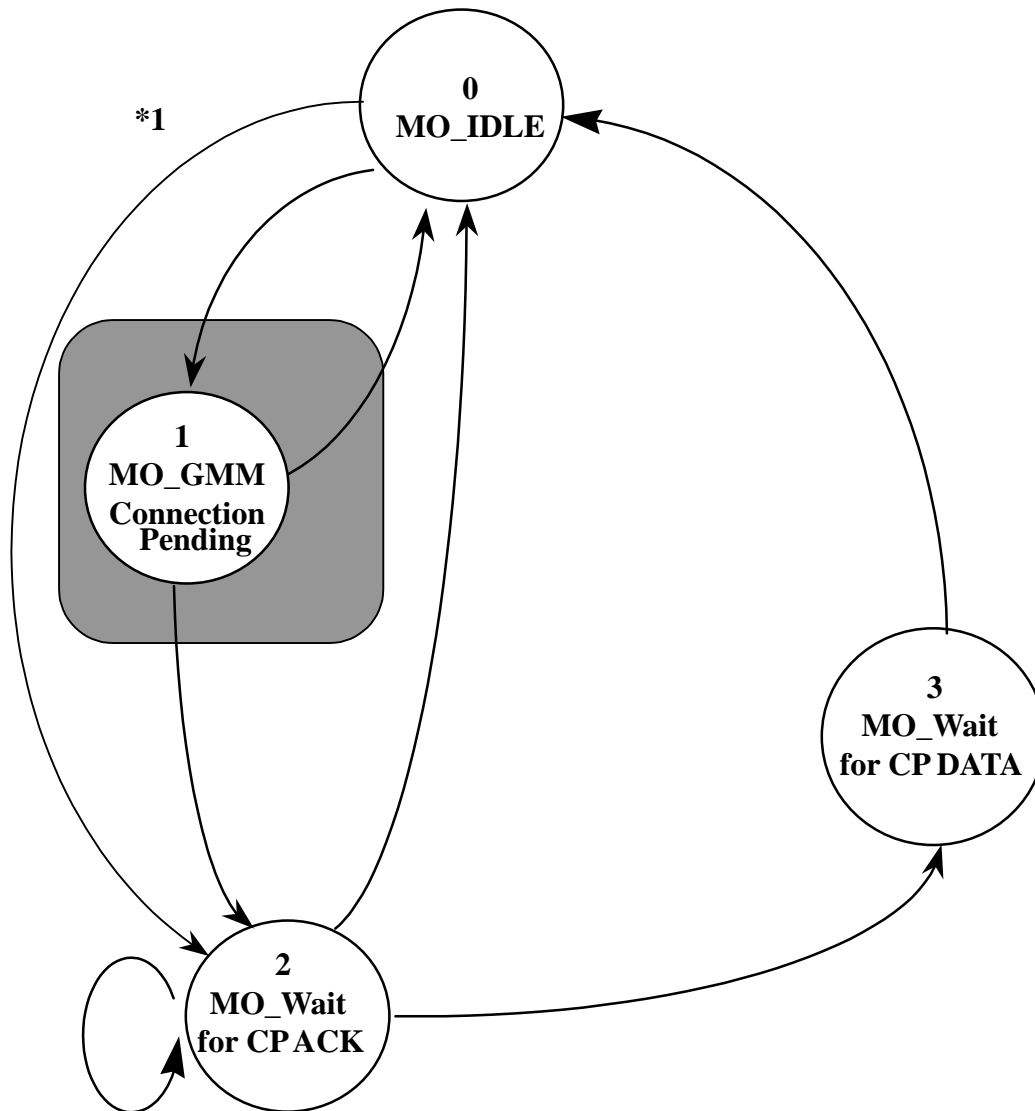

NOTE: The gray shaded area is applicable to UMTS only.  
 \*1: The arrow from MO\_IDLE to MO\_Wait for CP\_ACK is for GSM only.

**MO-SMC-GP entity on MS-side for GPRS  
 State transition diagram**

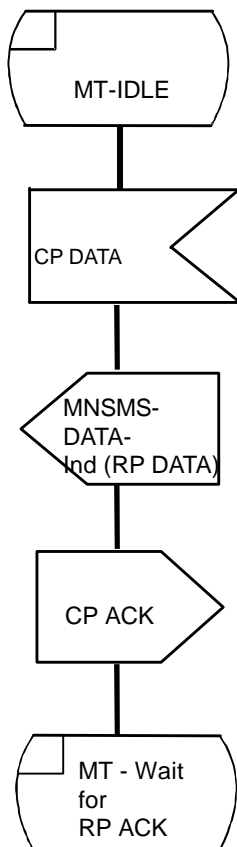

**MT-SMC-GP entity on MS-side for GPRS  
SDL-16**

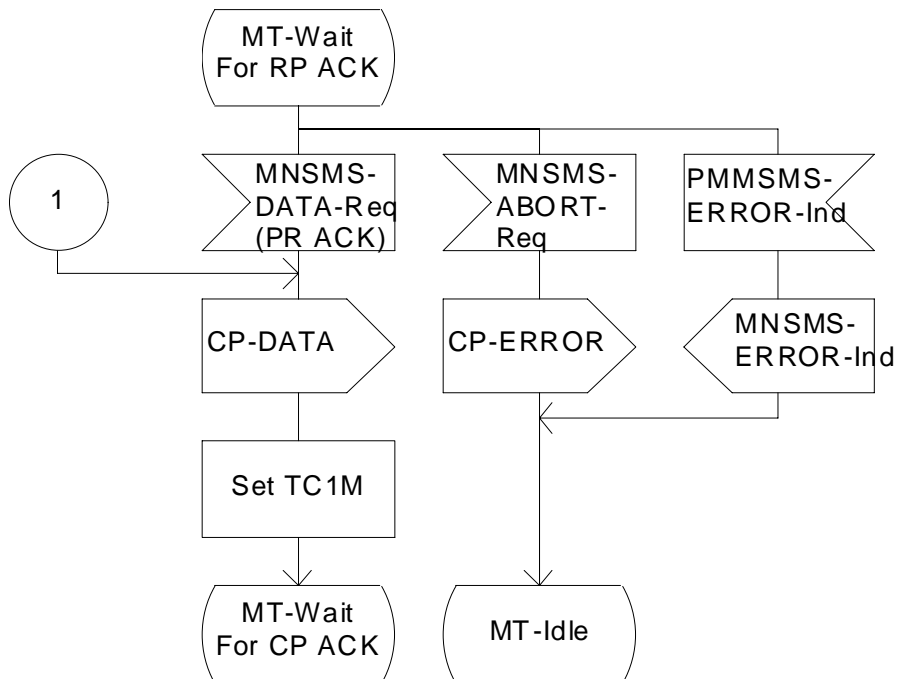

**MT-SMC-GP entity on MS-side for GPRS  
SDL-17**



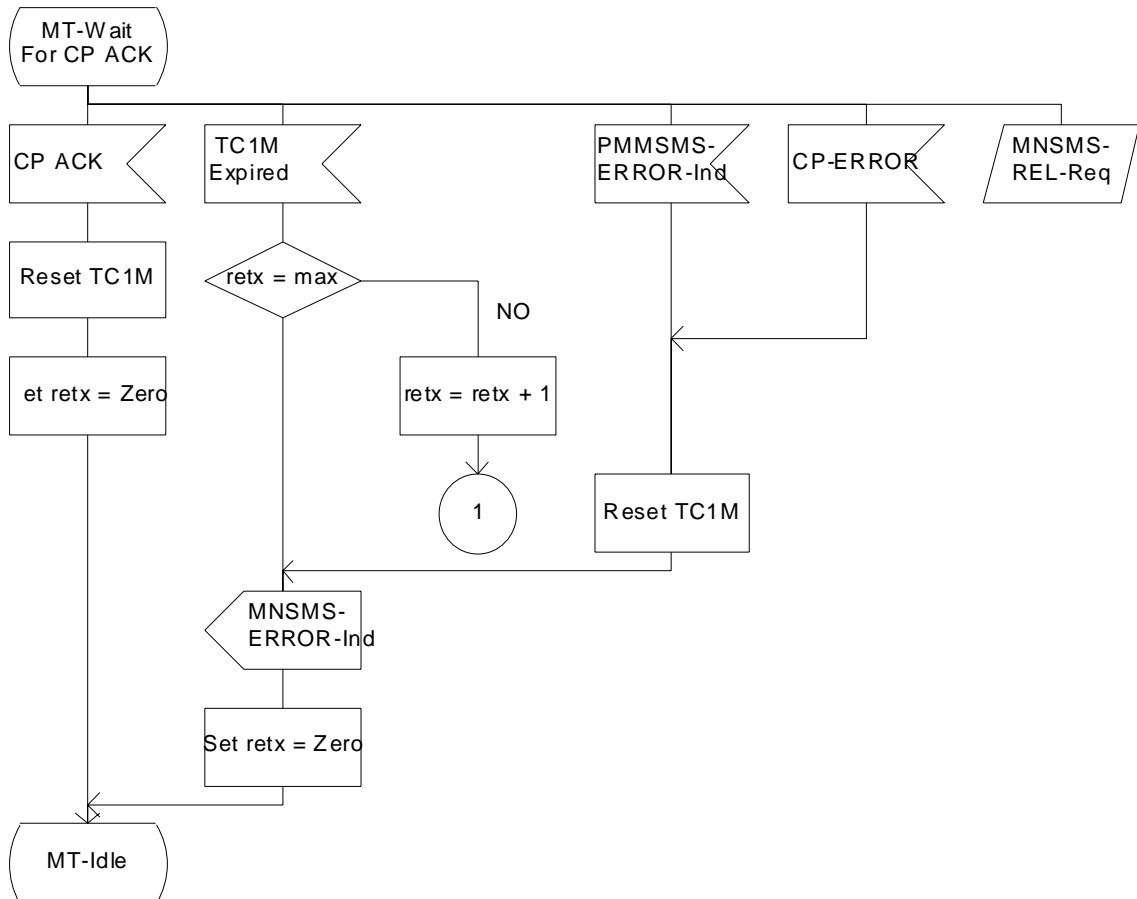

NOTE: The MNSMS-REL-Req is delayed until the next state

**MT-SMC-GP entity on MS-side for GPRS  
SDL-18**

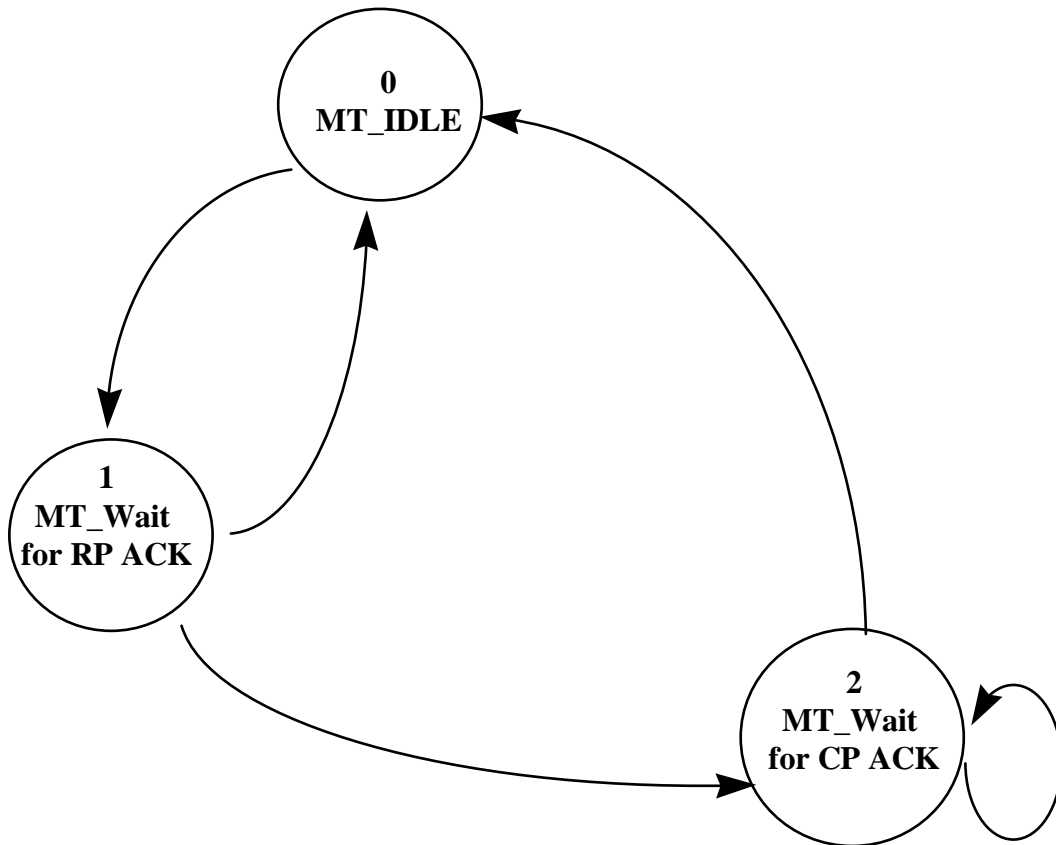

**MT-SMC-GP entity on MS-side for GPRS  
State transition diagram**

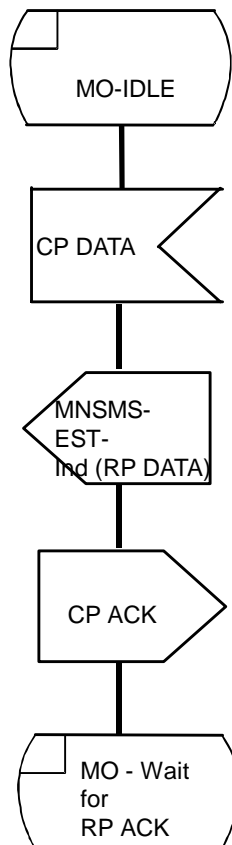

**MO-SMC-GP entity on Network side for GPRS  
SDL-19**

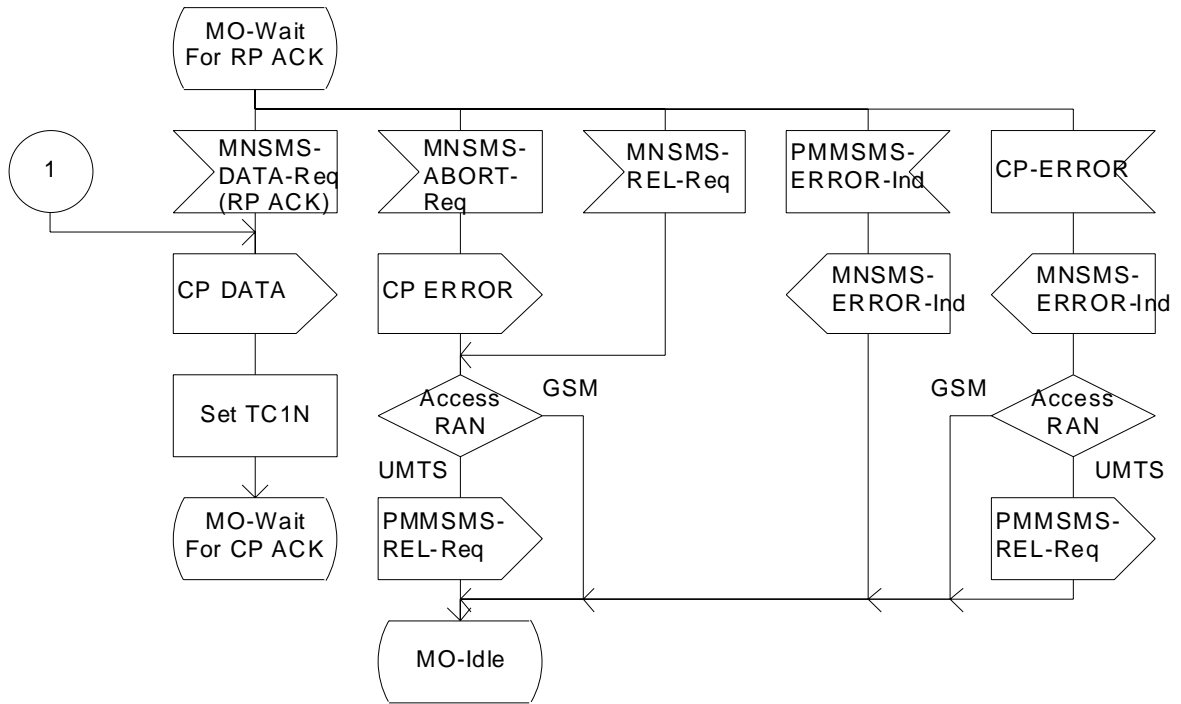

**MO-SMC-GP entity on Network side for GPRS  
SDL-20**

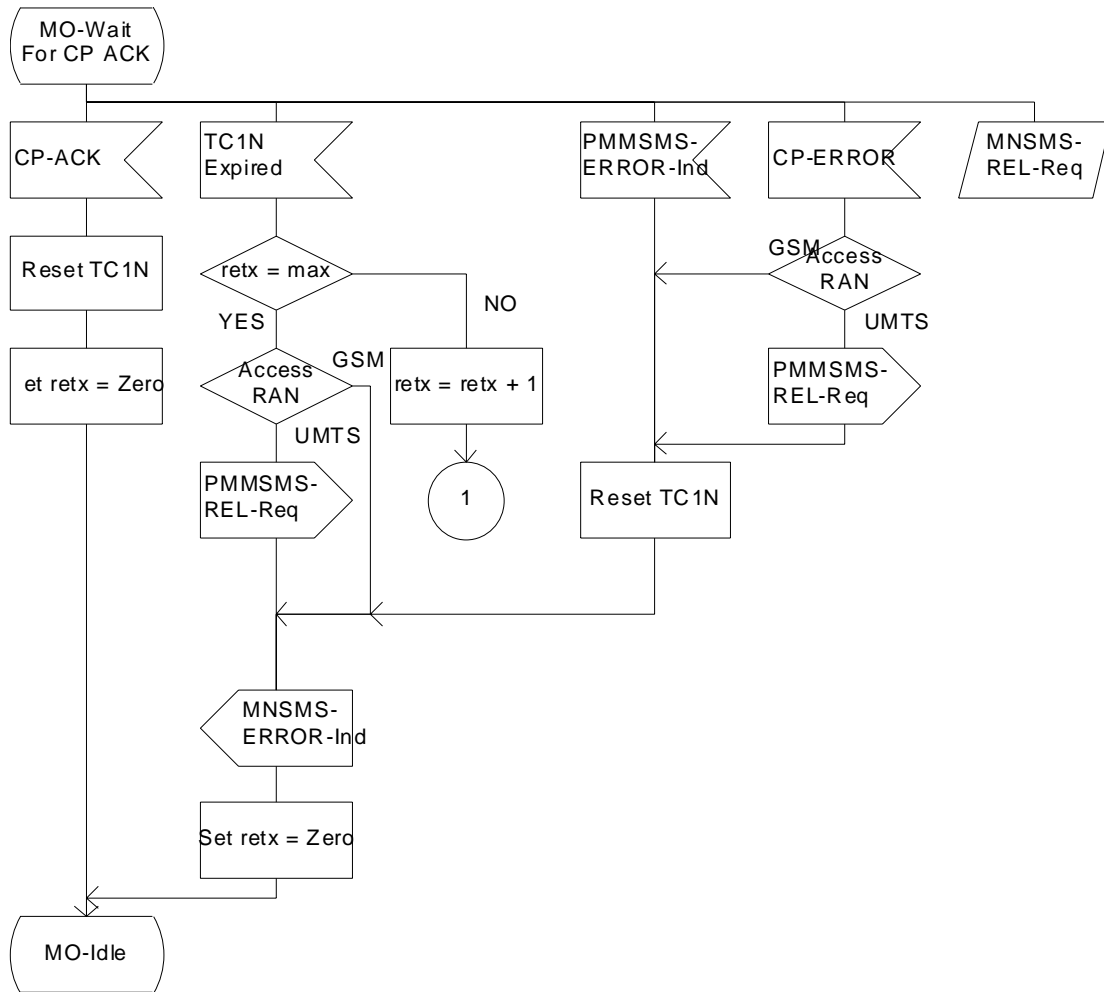

NOTE: The MNSMS-REL-Req is delayed until next state

**MO-SMC-GP entity on Network side for GPRS  
SDL-21**

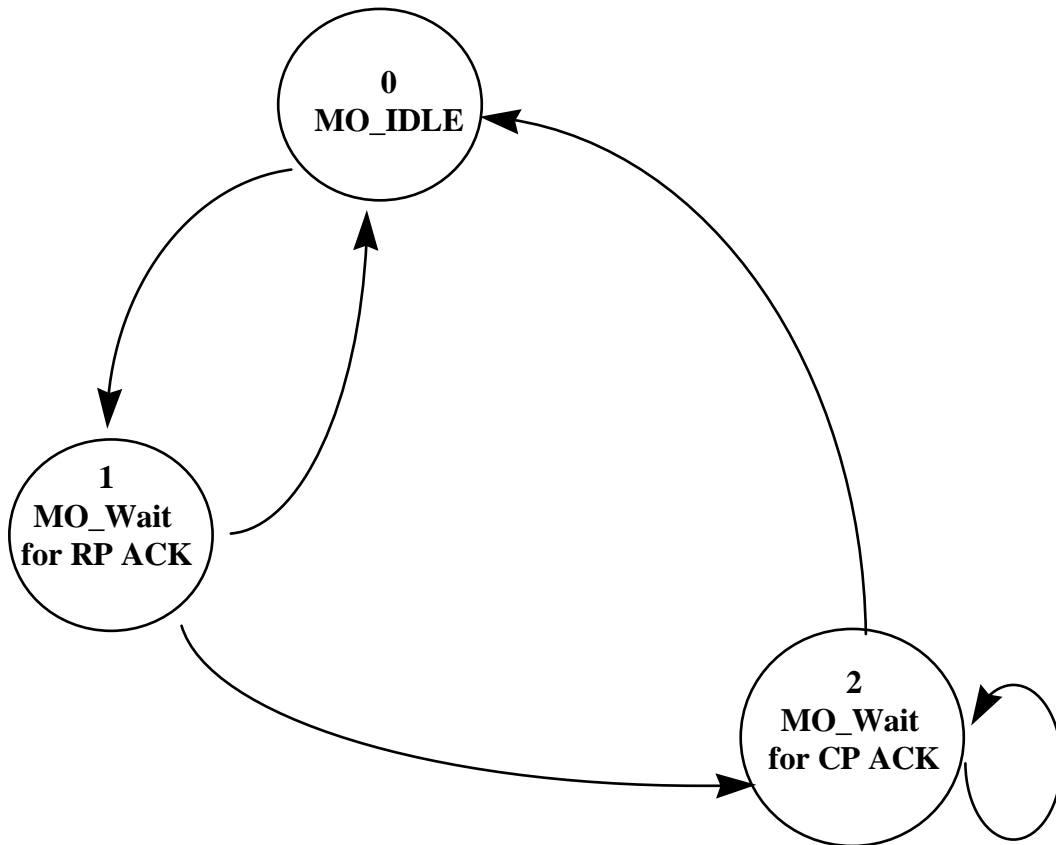

**MO-SMC-GP entity on Network-side for GPRS  
State transition diagram**

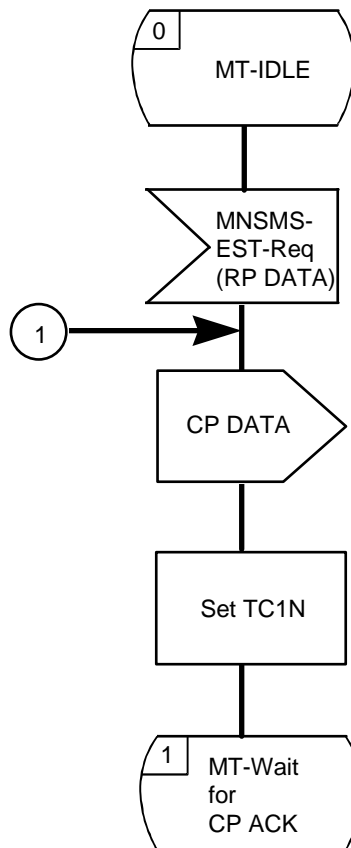

**MT-SMC-GP entity on Network-side for GPRS  
SDL-22**

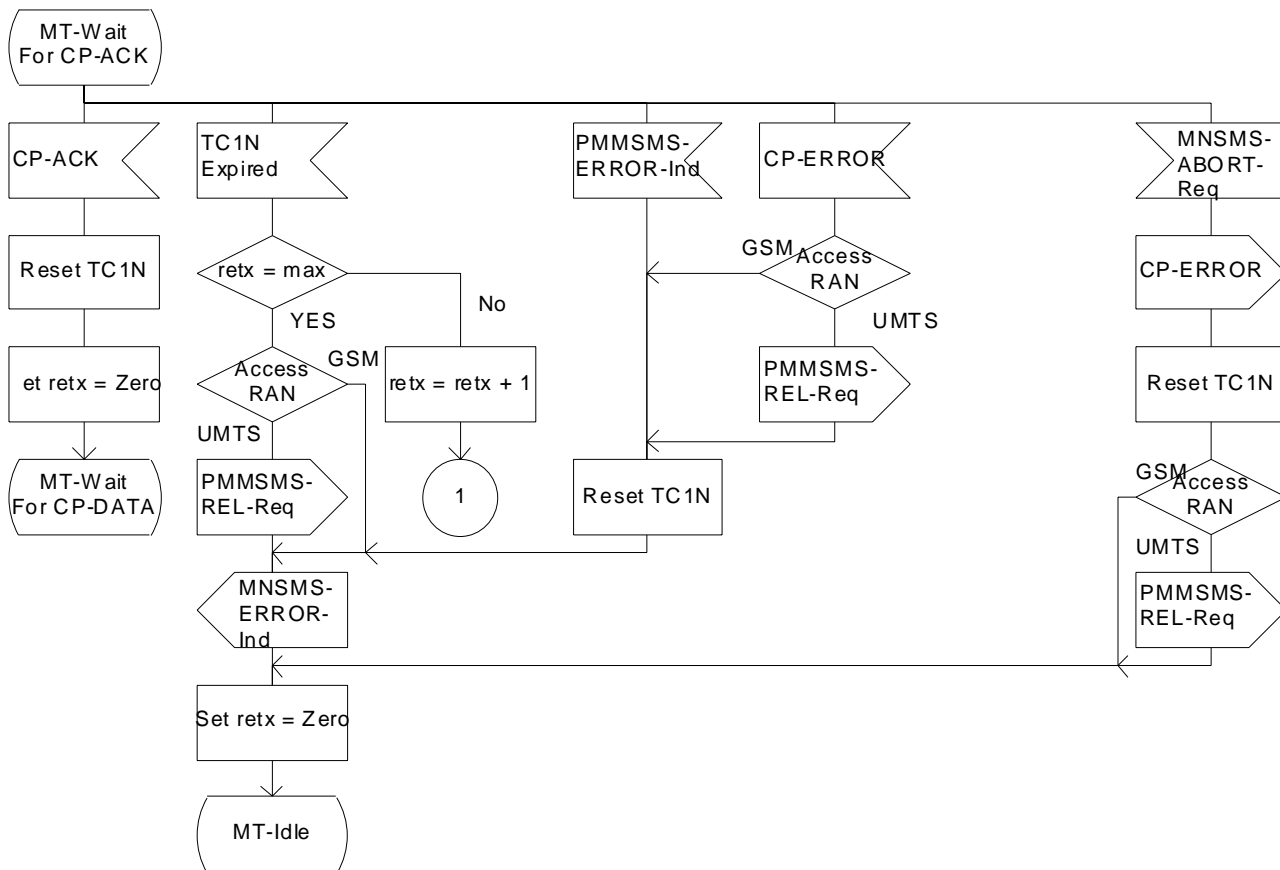

**MT-SMC-GP entity on Network-side for GPRS  
SDL-23**

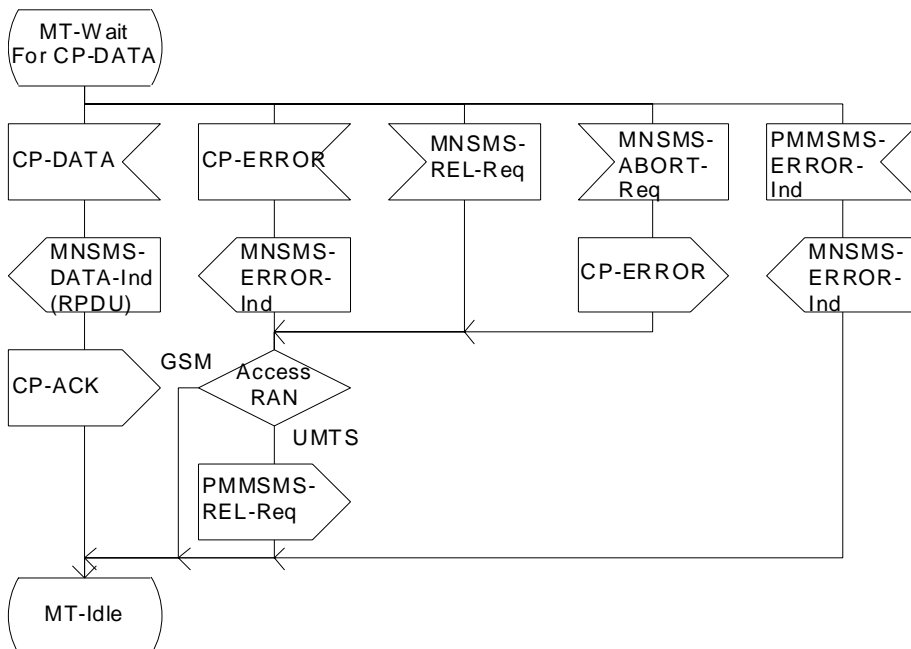

**MT-SMC-GP entity on Network-side for GPRS  
SDL-24**

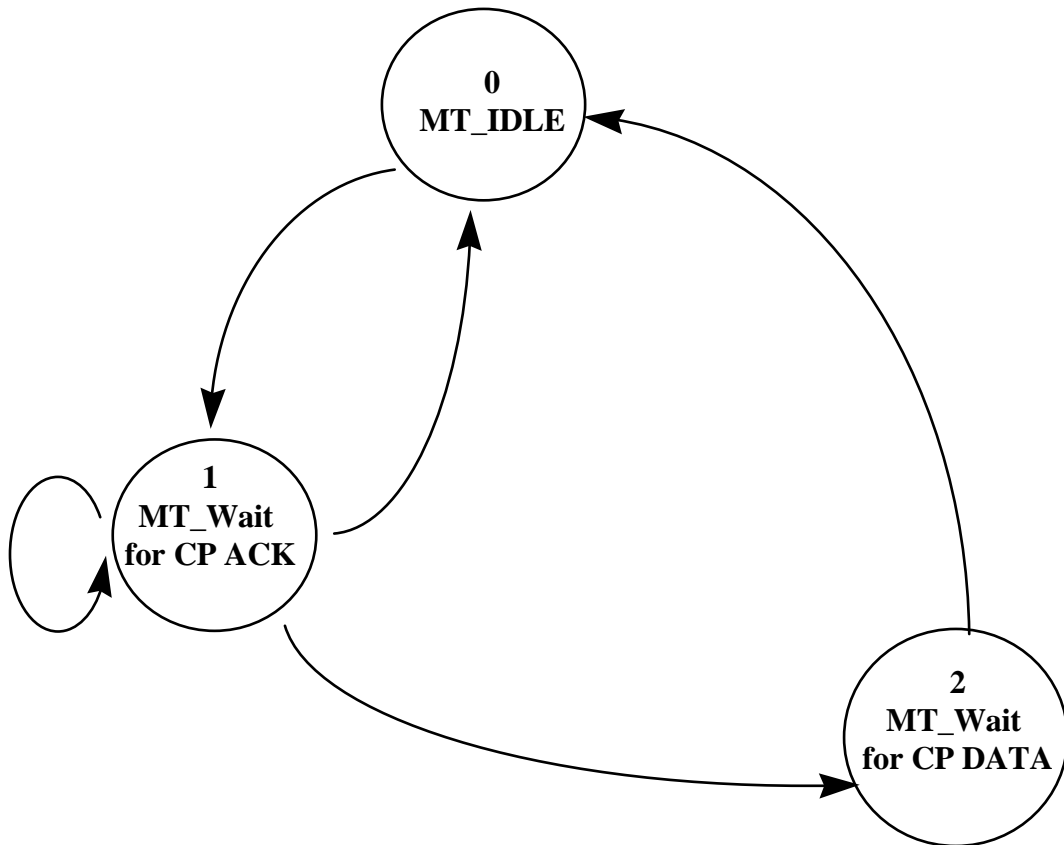

MT-SMC-GP entity on Network-side for GPRS  
State transition diagram

---

## History

<b>Document history</b>		
V1.1.1	July 2001	Membership Approval Procedure    MV 20010831: 2001-07-03 to 2001-08-31
V1.1.1	September 2001	Publication
V1.1.1	September 2001	Publication